



Oven

User manual and installation  
instructions

**B24CR31.0B**



**Futher information and explanations are available online:**



## Table of contents

### INFORMATION FOR USE

1	<b>Safety</b> .....	2
2	<b>Preventing material damage</b> .....	4
3	<b>Environmental protection and saving energy</b> .....	5
4	<b>Familiarising yourself with your appliance</b> .....	5
5	<b>Functions</b> .....	7
6	<b>Accessories</b> .....	9
7	<b>Before using for the first time</b> .....	10
8	<b>Basic operation</b> .....	11
9	<b>Time-setting options</b> .....	12
10	<b>Dishes</b> .....	13
11	<b>Favourites</b> .....	14
12	<b>Childproof lock</b> .....	14
13	<b>Rapid heating</b> .....	15
14	<b>Basic settings</b> .....	15
15	<b>Home Connect</b> .....	16
16	<b>Cleaning and servicing</b> .....	18
17	<b>Easy Clean cleaning aid</b> .....	20
18	<b>Drying</b> .....	20
19	<b>Rails</b> .....	21
20	<b>Appliance door</b> .....	21
21	<b>Troubleshooting</b> .....	24
22	<b>Disposal</b> .....	26
23	<b>Customer Service</b> .....	26
24	<b>Information regarding Free and Open Source Software</b> .....	26
25	<b>Declaration of Conformity</b> .....	27
26	<b>How it works</b> .....	27
27	<b>INSTALLATION INSTRUCTIONS</b> .....	34
27.1	<b>General installation instructions</b> .....	34

## 1 Safety

Observe the following safety instructions.

### 1.1 General information

- Read this instruction manual carefully.
- Keep the instruction manual and the product information safe for future reference or for the next owner.
- Do not connect the appliance if it has been damaged in transit.

### 1.2 Intended use

This appliance is designed only to be built into kitchen units. Read the special installation instructions.

Only a licensed professional may connect appliances without plugs. Damage caused by incorrect connection is not covered under the warranty.

Only use this appliance:

- To prepare meals and drinks.
- In private households and in enclosed spaces in a domestic environment.
- Up to an altitude of max. 4000 m above sea level.

### 1.3 Restriction on user group

This appliance may be used by children aged 8 or over and by people who have reduced physical, sensory or mental abilities or inadequate experience and/or knowledge, provided that they are supervised or have been instructed on how to use the appliance safely and have understood the resulting dangers.

Do not let children play with the appliance.

Children must not perform cleaning or user maintenance unless they are at least 15 years old and are being supervised.

Keep children under the age of 8 years away from the appliance and power cable.

## 1.4 Safe use

Always place accessories in the cooking compartment the right way round.

→ "Accessories", Page 9

### **⚠ WARNING – Risk of fire!**

Combustible objects that are left in the cooking compartment may catch fire.

- ▶ Never store combustible objects in the cooking compartment.
- ▶ If smoke is emitted, the appliance must be switched off or the plug must be pulled out and the door must be held closed in order to stifle any flames.

Loose food remnants, fat and meat juices may catch fire.

- ▶ Before using the appliance, remove the worst of the food residues and remnants from the cooking compartment, heating elements and accessories.

Opening the appliance door creates a draught. Greaseproof paper may come into contact with the heating element and catch fire.

- ▶ Never place greaseproof paper loosely over accessories when preheating the appliance and while cooking.
- ▶ Always cut greaseproof paper to size and use a plate or baking tin to hold it down.

### **⚠ WARNING – Risk of burns!**

The appliance and its parts that can be touched become hot during use.

- ▶ Caution should be exercised here in order to avoid touching heating elements.
- ▶ Young children under 8 years of age must be kept away from the appliance.

Accessories and cookware get very hot.

- ▶ Always use oven gloves to remove accessories or cookware from the cooking compartment.

When the cooking compartment is hot, any alcoholic vapours inside may catch fire. The appliance door may spring open. Hot steam and jets of flame may escape.

- ▶ Only use small quantities of drinks with a high alcohol content in food.
- ▶ Do not heat spirits ( $\geq 15\%$  vol.) when undiluted (e.g. for marinating or pouring over food).
- ▶ Open the appliance door carefully.

### **⚠ WARNING – Risk of scalding!**

The accessible parts of the appliance become hot during operation.

- ▶ Never touch these hot parts.
- ▶ Keep children at a safe distance.

Hot steam may escape when you open the appliance door. Steam may not be visible, depending on the temperature.

- ▶ Open the appliance door carefully.
- ▶ Keep children at a safe distance.

If there is water in the cooking compartment when it is hot, this may create hot steam.

- ▶ Never pour water into the cooking compartment when the cooking compartment is hot.

### **⚠ WARNING – Risk of injury!**

Scratched glass in the appliance door may develop into a crack.

- ▶ Do not use any harsh or abrasive cleaners or sharp metal scrapers to clean the glass on the oven door, as they may scratch the surface.

The appliance and its parts that can be touched may have sharp edges.

- ▶ Take care when handling and cleaning them.
- ▶ If possible, wear protective gloves.

The hinges on the appliance door move when the door is opened and closed, which could trap your fingers.

- ▶ Keep your hands away from the hinges. Components inside the appliance door may have sharp edges.
- ▶ Wear protective gloves.

### **⚠ WARNING – Risk of electric shock!**

Incorrect repairs are dangerous.

- ▶ Repairs to the appliance should only be carried out by trained specialist staff.
- ▶ Only use genuine spare parts when repairing the appliance.
- ▶ If the power cord of this appliance is damaged, it must be replaced by trained specialist staff.

If the insulation of the power cord is damaged, this is dangerous.

- ▶ Never let the power cord come into contact with hot appliance parts or heat sources.
- ▶ Never let the power cord come into contact with sharp points or edges.
- ▶ Never kink, crush or modify the power cord.

An ingress of moisture can cause an electric shock.

- ▶ Do not use steam- or high-pressure cleaners to clean the appliance.

If the appliance or the power cord is damaged, this is dangerous.

- ▶ Never operate a damaged appliance.
- ▶ Never pull on the power cord to unplug the appliance. Always unplug the appliance at the mains.
- ▶ If the appliance or the power cord is damaged, immediately unplug the power cord or switch off the fuse in the fuse box.

- ▶ Call customer services. → *Page 26*

### **⚠ WARNING – Risk of suffocation!**

Children may put packaging material over their heads or wrap themselves up in it and suffocate.

- ▶ Keep packaging material away from children.
- ▶ Do not let children play with packaging material.

Children may breathe in or swallow small parts, causing them to suffocate.

- ▶ Keep small parts away from children.
- ▶ Do not let children play with small parts.

---

## 2 Preventing material damage

### 2.1 General

#### **ATTENTION!**

Alcoholic vapours may catch fire in the hot cooking compartment and cause permanent damage to the appliance. The appliance door may spring open due to an explosion and it may fall off. The door panels may shatter and fragment. Due to the resulting negative pressure, the cooking compartment may become considerably deformed inwards.

- ▶ Do not heat spirits ( $\geq 15\%$  vol.) when undiluted (e.g. for marinating or pouring over food).

If there is water on the cooking compartment floor when operating the appliance at temperatures above  $120\text{ }^{\circ}\text{C}$ , this will damage the enamel.

- ▶ Do not use the appliance if there is water on the cooking compartment floor.
- ▶ Wipe away any water on the cooking compartment floor before operation.

Objects on the cooking compartment floor at over  $50\text{ }^{\circ}\text{C}$  will cause heat to build up. The baking and roasting times will no longer be correct and the enamel will be damaged.

- ▶ Do not place any accessories, greaseproof paper or foil of any kind on the cooking compartment floor.
- ▶ Only place cookware on the cooking compartment floor if a temperature under  $50\text{ }^{\circ}\text{C}$  has been set.

When the cooking compartment is hot, any water inside it will create steam. The change in temperature may cause damage.

- ▶ Never pour water into the cooking compartment when it is still hot.
- ▶ Never place cookware containing water on the cooking compartment floor.

The prolonged presence of moisture in the cooking compartment leads to corrosion.

- ▶ Allow the cooking compartment to dry after use. To do this, open the cooking compartment door completely or use the drying function.

- ▶ Do not keep moist food in the cooking compartment for a long time with the door closed.
- ▶ Do not store food in the cooking compartment.
- ▶ Take care not to trap anything in the appliance door.

Fruit juice dripping from the baking tray leaves stains that cannot be removed.

- ▶ When baking very juicy fruit flans, do not pack too much on the baking tray.
- ▶ If possible, use the deeper universal pan.

Using oven cleaner in a hot cooking compartment damages the enamel.

- ▶ Never use oven cleaner in the cooking compartment when it is still warm.
- ▶ Remove all food remnants from the cooking compartment and the appliance door before you next heat up the appliance.

If the seal is very dirty, the appliance door will no longer close properly during operation. This may damage the front of adjacent kitchen units.

- ▶ Keep the seal clean at all times.
- ▶ Never operate the appliance if the seal is damaged or missing.

Sitting or placing objects on the appliance door may damage it.

- ▶ Do not place, hang or support objects on the appliance door.
- ▶ Do not place cookware or accessories on the appliance door.

With certain models, accessories may scratch the door pane when closing the appliance door.

- ▶ Always push accessories fully into the cooking compartment.

If aluminium foil comes into contact with the door pane, it could cause permanent discolouration.

- ▶ Do not allow aluminium foil in the cooking compartment to come into contact with the door pane.



## 3 Environmental protection and saving energy

### 3.1 Disposing of packaging

The packaging materials are environmentally compatible and can be recycled.

- ▶ Sort the individual components by type and dispose of them separately.

### 3.2 Saving energy

If you follow these instructions, your appliance will use less power.

Only preheat the appliance if the recipe or the recommended settings tell you to do so.

- Not preheating the appliance can reduce the energy used by up to 20%.

Use dark-coloured, black-coated or enamelled baking tins.

- These types of baking tin absorb the heat particularly well.

Open the appliance door as little as possible during operation.

- This maintains the temperature in the cooking compartment and eliminates the need for the appliance to reheat.

When baking multiple dishes, do so in succession or in parallel.

- The cooking compartment is heated after baking the first dish. This reduces the baking time for the second cake.

If the cooking time is relatively long, you can switch the appliance off 10 minutes before the cooking time ends.

- There will be enough residual heat to finish cooking the dish.

Remove any accessories that are not being used from the cooking compartment.

- Accessories that are not being used do not need to be heated.

Allow frozen food to defrost before cooking.

- This saves the energy that would otherwise be required to defrost it.

Switch off the display in the basic setting.

- Energy is saved when the display is switched off.

#### Note:

The appliance requires:

- A maximum of 2 W in networked standby mode
- A maximum of 1 W in non-networked standby mode with the display switched on
- A maximum of 0.5 W in non-networked standby mode with the display switched off

## 4 Familiarising yourself with your appliance

### 4.1 Control panel

You can use the control panel to configure all functions of your appliance and to obtain information about the operating status.

On certain models, specific details such as colour and shape may differ from those pictured.

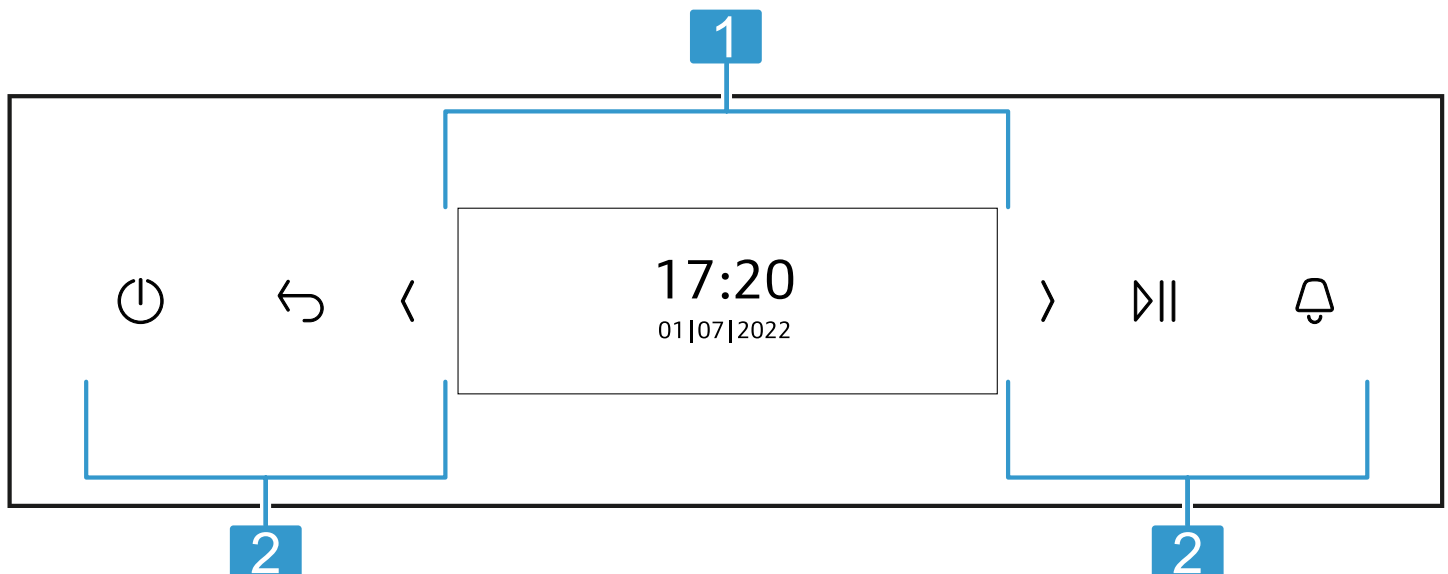

- 1** Display  
→ "Display", Page 6
- 2** Buttons  
→ "Buttons", Page 6

## 4.2 Display

You can configure all the functions on your appliance via the display.  
The main menu provides an overview of your appliance's functions.  
→ "Functions", Page 7

### Navigating

Direction	Use
Navigate to the left	Swipe right on the display with your finger
Navigate to the right	Swipe left on the display with your finger

## 4.3 Buttons

The buttons are touch-sensitive areas. To select a function, press the corresponding button.

Symbol	Name	Use
⏻	On/Off	Switch the appliance on or off
↶	Back	Navigate back
<	Left arrow	Decreases the adjustment values
>	Right arrow	Increases the adjustment values
⏸	Start/stop	Start or pause the appliance
🔔	Timer	Set the timer

## 4.4 Cooking compartment

Various functions in the cooking compartment provide support when operating your appliance.

### Shelf supports

The shelf supports in the cooking compartment enable you to place accessories at different heights.  
→ "Accessories", Page 9  
Your appliance has 4 shelf positions. The shelf positions are numbered from bottom to top.  
You can remove the shelf supports, e.g. for cleaning.  
→ "Rails", Page 21

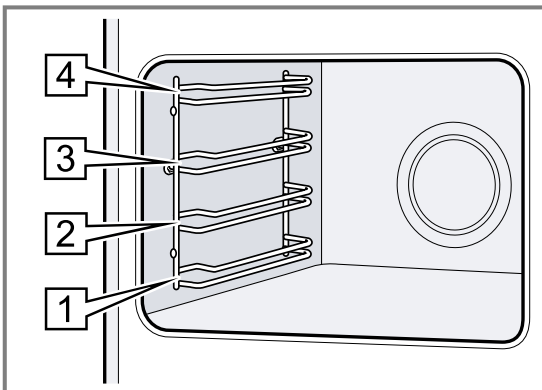

### Setting values

To adjust a setting, touch the appropriate place on the display with your finger. The settings area appears on the display. Swipe left or right over this settings area on the display with your finger until the required setting is magnified.

Values	Use
Increase	Swipe right on the display with your finger
Decrease	Swipe left on the display with your finger

### Self-cleaning surfaces

The back panel in the cooking compartment is self-cleaning. The self-cleaning surfaces are coated with a porous, matt ceramic layer and have a rough surface. When the appliance is in operation, the self-cleaning surfaces absorb splashes from roasting or grilling and break them down.  
If the self-cleaning surfaces no longer clean themselves adequately during operation, heat up the cooking compartment specifically to the right temperature.  
→ "Regenerating self-cleaning surfaces in the cooking compartment", Page 19

### Lighting

One or more oven lights illuminate the cooking compartment.  
When you open the appliance door, the light in the cooking compartment switches on. If the appliance door remains open for longer than 15 minutes, the light switches off again.  
For most functions, the lighting is switched on during operation. The lighting switches off again when the operation ends.

### Cooling fan

The cooling fan switches on and off depending on the appliance's temperature. The hot air escapes above the door.



**ATTENTION!**

Covering the ventilation slots will cause the appliance to overheat.

- ▶ Do not cover the ventilation slots.

To ensure that the appliance cools down more quickly after operation, the cooling fan continues to run for a certain period afterwards.







**Appliance door**

If you open the appliance door during operation, the operation stops. If you close the appliance door, operation resumes automatically.

## 5 Functions

The main menu provides an overview of your appliance's functions.









**Tip:** Depending on the appliance type, additional or more comprehensive functions are available to you with the Home Connect app. You can find more information about this in the app.







Function	Name	Use
	Types of heating	Select the required type of heating and temperature for your food
	Favourites	Select saved favourites
	Dishes	Use programmes or recommended settings for various types of food
	Cleaning	<ul style="list-style-type: none"> <li>▪ Easy Clean  removes light dirt from the cooking compartment → "Easy Clean cleaning aid", Page 20</li> <li>▪ Drying function  dries the cooking compartment</li> </ul>
	Basic settings	Individually adjust the appliance settings → "Basic settings", Page 15

### 5.1 Heating functions

This is where you will find an overview of the types of heating. You will find recommendations for using the types of heating.

For temperatures above 275 °C, the appliance reduces the temperature to approx. 275 °C after around 40 minutes.



Symbol	Heating function	Temperature	Use
	Circo Therm hot air	30 - 230 °C	Bake or roast on one or more levels. The fan distributes the heat from the ring-shaped heating element in the back wall evenly around the cooking compartment.
	Top/bottom heat	30 - 275 °C	Traditionally bake or roast on one level. This type of heating is especially good for cakes with moist toppings. The heat is emitted evenly from above and below.
	Circo Therm gentle	125 - 230 °C	For gently cooking selected types of food on one level without preheating. The fan distributes the heat from the ring-shaped heating element in the back wall around the cooking compartment. This type of heating is used to determine the energy consumption in circulating-air mode and the energy efficiency class.
	Top/bottom heat gentle	150 - 250 °C	For gently cooking selected types of food without preheating. Heat is emitted from above and below. This type of heating is used to determine the energy consumption in the conventional mode.
	Circo-roasting	30 - 275 °C	Roast poultry, whole fish or larger pieces of meat. The grill element and the fan switch on and off alternately. The fan circulates the hot air around the food.
	Pizza setting	30 - 275 °C	Cook pizza or food that requires a lot of heat from below. The bottom heating element and the ring-shaped heating element in the back wall heat the cooking compartment.
	Bread baking setting	180 - 275 °C	For baking bread, bread rolls and baked goods that require high temperatures.
	Full-surface grill	50 - 290 °C	For grilling flat items such as steaks, sausages or bread, and for cooking au gratin. The entire area below the grill element becomes hot.

Symbol	Heating function	Temperature	Use
	Centre-area grill	50 - 290 °C	For grilling small amounts of steaks, sausages or bread, and for cooking au gratin. The central area below the grill element becomes hot.
	Slow cooking	70 - 120 °C	For gentle, slow cooking of seared, tender pieces of meat in cookware without a lid. The heat is emitted evenly from above and below at a low temperature.
	Dough proving	30 - 50 °C	For proving dough and culturing yoghurt. Dough will prove more quickly than at room temperature. The surface of the dough does not dry out.
	Bottom heat	30 - 250 °C	For cooking in a bain marie and for baking food for extra time. The heat is emitted from below.
	Keep warm	50 - 100 °C	For keeping cooked food warm.
	Plate warming	30 - 90 C	For heating cookware.

## 5.2 Additional options













You can find an overview of other options here.

To display the options, press  :

Symbol	Name	Use
	Lighting	Switch the lighting in the cooking compartment on or off
	Childproof lock	Activate the childproof lock
	Remote start	Activate remote start → "Home Connect ", Page 16

## 5.3 Symbols

You can find an overview of other symbols on the display here.

Symbol	Name	Use
	Save	Save the setting
	Close	Close the message
	Reset	Reset the cooking time
	Reset	Reset the values
	Change	Change the selection
	Information	Display information
	Rapid heating	Activate or deactivate the rapid heating function
	Home Connect	<ul style="list-style-type: none"> <li>■ Home network and Home Connect server connected</li> <li>■ The number of lines shows the signal strength of the home network</li> </ul> → "Home Connect ", Page 16
	Home network	Home network not connected → "Home Connect ", Page 16
	Home Connect server	Home Connect server not connected → "Home Connect ", Page 16
	Remote diagnostics	Remote diagnostics activated → "Home Connect ", Page 16
	New function	A new function is available if a red symbol is displayed in the main menu → "Home Connect ", Page 16



## 6 Accessories

Use original accessories. These have been made especially for your appliance.

**Note:** Accessories may become deformed if they get hot. Deformation has no effect on function. As the accessory cools down, it will regain its original shape.

The accessories supplied may differ depending on the appliance model.

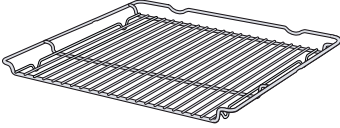
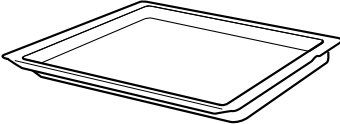
Accessories		Use
Wire rack		<ul style="list-style-type: none"> <li>■ Cake tins</li> <li>■ Ovenproof dishes</li> <li>■ Cookware</li> <li>■ Meat, e.g. roasting joints or steak</li> <li>■ Frozen meals</li> </ul>
Universal pan		<ul style="list-style-type: none"> <li>■ Moist cakes</li> <li>■ Baked items</li> <li>■ Bread</li> <li>■ Large roasts</li> <li>■ Frozen meals</li> <li>■ Catch dripping liquids, e.g. fat when grilling food on the wire rack.</li> </ul>

### 6.1 Locking function

The locking function prevents the accessories from tilting when they are pulled out.

You can pull out the accessories approximately halfway without them tipping. The accessories must be inserted into the cooking compartment correctly for the tilt protection to work properly.

### 6.2 Sliding accessories into the cooking compartment

Always slide the accessory into the cooking compartment the right way round. This is the only way to ensure that accessories can be pulled out approximately halfway without tipping.

1. Turn the accessories so that the notch  is at the rear and is facing downwards.
2. Insert the accessory between the two guide rods for a shelf position.

Wire rack Insert the wire rack with the open side facing the appliance door.

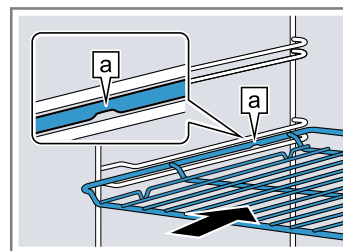

Tray  
E.g. universal pan or baking tray Slide the tray in with the sloping edge  towards the appliance door.

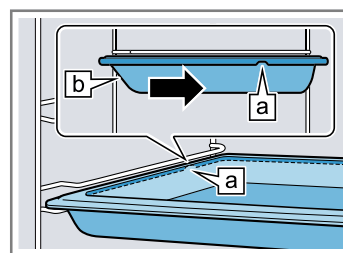

3. Push the accessory all the way in, making sure that it does not touch the appliance door.

**Note:** Take any accessories that you will not be using out of the cooking compartment while the appliance is in operation.

### Combining accessories

You can combine the wire rack with the universal pan to catch any liquid that drips down.

1. Place the wire rack on the universal pan so that both spacers  are on the rear edge of the universal pan.
2. Insert the universal pan between the two guide rods for a shelf position. In so doing, the wire rack is on top of the upper guide rod.

Wire rack  
on univer-  
sal pan

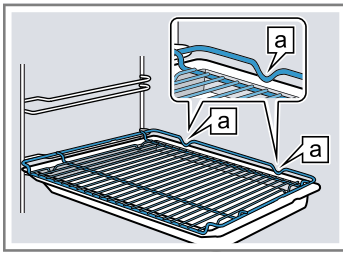

## 6.3 Other accessories

You can purchase other accessories from our after-sales service, specialist retailers or online. You will find a comprehensive range of products for your appliance in our brochures and online: [www.neff-international.com](http://www.neff-international.com)

Accessories vary from one appliance to another. When purchasing accessories, always quote the exact product number (E no.) of your appliance. You can find out which accessories are available for your appliance in our online shop or from our after-sales service.

## 7 Before using for the first time

Configure the settings for initial start-up. Clean the appliance and accessories.

### 7.1 Initial use

After connecting the appliance to the power supply, you must configure the settings for its initial start-up. It may take a few minutes for the settings to appear on the display.

#### Notes

- You can adjust the settings at any time in the basic settings.  
→ *"Basic settings", Page 15*
- You can also use Home Connect to configure the settings. When your appliance is connected, follow the instructions in the app.  
→ *"Home Connect", Page 16*

### Setting the language

**Requirement:** The appliance is connected to the power supply.

1. Press  $\odot$  to switch the appliance on.
2. Use the  $\langle$  or  $\rangle$  button to select the language.
3. Press the required language.
4. Press  $\rightarrow$  to confirm the language.

### Setting up Home Connect

**Note:** You can skip Home Connect set-up by pressing "Later". Next, set the clock.

1. Press "Connect" to set up Home Connect.  
→ *"Home Connect", Page 16*
2. Make all other settings for initial start-up in the Home Connect app.

### Setting the time

1. Use  $\langle$  or  $\rangle$  to select the hours.
2. Press the minutes.
3. Use  $\langle$  or  $\rangle$  to select the minutes.
4. Press  $\checkmark$  to confirm the time.

### Setting the date

1. Use  $\langle$  or  $\rangle$  to select the year.

2. Press the month.
3. Use  $\langle$  or  $\rangle$  to select the month.
4. Press the day.
5. Use  $\langle$  or  $\rangle$  to select the day.
6. Press  $\checkmark$  to confirm the date.
7. Press "OK" to end the initial start-up.
8. Open and close the appliance door once.
  - ✓ The appliance will perform a self-test, after which it will be ready to use.
  - ✓ The initial start-up is now complete.

### 7.2 Cleaning the appliance

Before using the appliance to cook food for the first time, you must clean the cooking compartment and accessories.

1. Remove the product information, accessories and any leftover packaging (e.g. polystyrene pellets) from the cooking compartment.
2. Wipe the smooth surfaces in the cooking compartment with a soft, damp cloth.
3. Press  $\odot$  to switch the appliance on.  
→ *"Switching on the appliance", Page 11*
4. Set the required type of heating and temperature for the heat-up process and press  $\gg$  to start.  
→ *"Setting the type of heating and temperature", Page 11*

#### Heating up

Type of heating	Circo Therm hot air $\infty$
Temperature	Maximum
Cooking time	1 hour

5. Ventilate the kitchen while the appliance is heating.
6. Press  $\odot$  to switch off the appliance after 1 hour.  
→ *"Switching off the appliance", Page 11*
7. Allow the appliance to cool down.
8. Clean the smooth surfaces with soapy water and a dish cloth.
9. Thoroughly clean any accessories you used with soapy water and a dish cloth.



## 8 Basic operation

### 8.1 Switching on the appliance

#### ATTENTION!

If there is water on the cooking compartment floor when operating the appliance at temperatures above 120 °C, this will damage the enamel.

- ▶ Do not use the appliance if there is water on the cooking compartment floor.
- ▶ Wipe away any water on the cooking compartment floor before operation.
- ▶ Press  to switch the appliance on.

#### Notes

- In the basic settings, you can specify whether the display shows the main menu or another function when the appliance is switched on.  
→ "Basic settings", Page 15
- If you do not perform any actions on the appliance for an extended period, it will automatically switch itself off.

### 8.2 Switching off the appliance

- ▶ Press  to switch the appliance off.

#### Notes







- The residual heat indicator will appear on the display while the cooking compartment is still hot.  
→ "Residual heat indicator", Page 11
- The cooling fan will continue to run until the cooking compartment has cooled down.  
→ "Cooling fan", Page 6

### 8.3 Residual heat indicator

After you have switched off the appliance, the residual heat indicator will appear on the display.

Display	Temperature
Residual heat high	Over 120 °C
Residual heat low	Between 60 and 120 °C

### 8.4 Setting the type of heating and temperature

1. Press  to switch the appliance on.
2. Press "Types of heating".
3. Scroll through the types of heating using  or .
4. Press the type of heating that you want to use.
5. Press "Temperature".
6. Use  or  to select the temperature.
7. Press  to confirm the setting.

Also available to select:

- Rapid heating → Page 15
- Cooking time → Page 12
- Ready at → Page 12
- Information → Page 11

8. Press  to start the operation.



**Note:** When you are preheating the appliance, the optimal time to place your food in the cooking compartment is as soon as the heat-up indicator is filled.

- ✓ The cooking time appears on the display.
- ✓ The heat-up indicator bar visualises the rising temperature.

9. When the food is ready, use  to switch the appliance off.





### 8.5 Changing the temperature

You can also change the temperature or level once you have started the appliance.



1. Press "Temperature".
2. Use  or  to change the temperature.
3. Press  to confirm the setting.
- ✓ The temperature is changed.

### 8.6 Changing the type of heating

If you switch to a different type of heating, the appliance will reset all the settings.

1. Press  to pause operation.
2. Press  to switch to the types of heating.
3. Scroll through the types of heating using  or .
4. Press the type of heating that you want to use.
5. Adjust the temperature or level, if required.
6. Press  to start the operation.

### 8.7 Pausing operation

1. Press .
2. Press  again to resume operation.

### 8.8 Displaying information

**Note:** In most cases, you can call up information about the function that you have just started.

1. Press "Information".
- ✓ The information will be displayed for a few seconds.
2. Press  to close the information.

### 8.9 Sabbath-compliant use

If you want to operate your appliance so that it is Sabbath-compliant, use the time-setting options and change the basic setting for the lighting.

**Note:** If you open the appliance door during operation, the appliance stops heating. When you close the appliance door, the appliance continues to heat again.

1. Change the "Lighting" basic setting to "Always off".  
→ "Basic settings", Page 15  
This will ensure that the light in the cooking compartment is always off while the appliance is in operation and when you open the appliance door.
2. Set the required type of heating.  
→ "Setting the type of heating and temperature", Page 11
3. Set the required cooking time depending on the type of heating.  
→ "Cooking time", Page 12
4. Use "Ready at" to set the time at which the operation should end.  
→ "Delayed start/"Ready at" time", Page 12
5. Place the food in the cooking compartment before the appliance starts to heat.
6. Press  to start the operation.



- ✓ The display shows the start time. The appliance is in standby mode.
- ✓ Once the start time has been reached, the appliance starts heating and the cooking time starts counting down.

7. When the operation has ended, remove the food from the cooking compartment. The appliance automatically switches off completely after approximately 15 to 20 minutes.
 

**Note:** If necessary, change the basic setting for the lighting again.

## 9 Time-setting options





Your appliance has different time-setting options, with which you can control its operation.

Time-setting option	Use
Timer 	You can set the timer to run independently of the appliance during operation. The timer does not affect the appliance.
Cooking time 	Once the set duration has elapsed, the appliance stops heating automatically.
Ready at 	Along with the duration, you can set the time at which you want the operation to end. The appliance starts up automatically so that the operation finishes at the required time.





### 9.1 Timer

You can set the timer regardless of whether the appliance is on or off.



#### Setting the timer

1. Press .
2. Press Hours, Minutes or Seconds.
3. Use  or  to select the timer duration.
4. Press  to confirm the setting.
- ✓  lights up red. The timer counts down.
- ✓ Once the timer duration has elapsed, an audible signal sounds.
5. Press any button to end the audible signal.

#### Changing the timer

1. Press .
2. Press .
3. Press Hours, Minutes or Seconds.
4. Use  or  to change the timer duration.
5. Press  to confirm the setting.

#### Cancelling the timer





1. Press .
2. Press  to reset the timer duration.
3. Press  to close the timer.

### 9.2 Cooking time





Once the set duration has elapsed, the appliance stops heating automatically. You can only use the cooking time in conjunction with a type of heating.

#### Setting the cooking time



1. Set a type of heating and a temperature.
2. Press "Cooking time".
3. Press Hours or Minutes.

4. Use  or  to select the cooking time.
5. Press  to confirm the setting.
6. Press  to start operation with a cooking time.
  - ✓ The cooking time appears on the display. The cooking time counts down.
  - ✓ When the time has elapsed, a signal sounds.
7. Press any button to end the audible signal.

#### Changing the cooking time

1. Press .
2. Press "Cooking time".
3. Use  or  to change the cooking time.
4. Press  to confirm the setting.

#### Cancelling the cooking time







1. Press .
2. Press "Cooking time".
3. Reset the cooking time using .
4. Press  to confirm the setting.

### 9.3 Delayed start/"Ready at" time

With this function, the appliance automatically switches itself on, and then switches itself off at the preselected end time. To enable it to do this, you set the cooking time (duration) and specify when you want your food to be ready. You can only use the delayed start function in conjunction with a heating function.

#### Setting the "Ready at" time for delayed starts

##### Notes

- Do not leave food that spoils easily in the cooking compartment for too long.
  - You cannot use the delayed start function with every type of heating.
1. Place the food into the cooking compartment and close the appliance door.
  2. Set a type of heating and a temperature.
  3. Press "Cooking time".
  4. Press Hours or Minutes.
  5. Use  or  to select the cooking time.
  6. Press  to confirm the setting.
  7. Press "Ready at".
    - ✓ The time at which your food will be ready will appear on the display.
  8. Use the  button to select the required end time.
  9. Press  to confirm the setting.
  10. Press  to confirm the delayed start.
    - ✓ The appliance will start at the appropriate time.
    - ✓ When the time has elapsed, a signal sounds.
  11. Press any button to end the audible signal.

#### Changing the "Ready at" time for delayed starts

1. Press .
2. Press "Ready at".

3. Use < or > to change the end time.
4. Press ✓ to confirm the setting.

### Cancelling the "Ready at" time for delayed starts

1. Press ▷||.
2. Press "Ready at".
3. Use ⏮ to reset the end time.

4. Press ✓ to confirm the setting.
  - ✓ The end time corresponds to the current time plus the set cooking time.
  - ✓ The operation starts with the set cooking time.

**Note:** If you want to continue the operation without a cooking time, cancel the cooking time.  
→ "Cancelling the cooking time", Page 12

## 10 Dishes

"Dishes" helps you to use your appliance to prepare different dishes by selecting the optimum settings automatically.

### 10.1 Cookware for dishes

The cooking result depends on the composition of the meat and the size of cookware.

You should therefore use heat-resistant cookware that is suitable for temperatures up to 300 °C. Glass or glass ceramic cookware is best. The joint should cover approx. 2/3 of the cookware base.

Cookware made from the following material is not suitable:

- Bright, shiny aluminium
- Unglazed clay
- Plastic or plastic handles

### 10.2 Setting options for the dishes

To cook the dishes perfectly, the appliance uses different settings depending on the dish.

The display shows you the settings that are used. You can adjust certain settings. Follow the instructions on the display.

**Note:** The cooking result depends on the quality and composition of the food. Use fresh and, ideally, chilled food. Use frozen food straight from the freezer.

#### Tips and information about the settings

If you set a dish, the display shows relevant information for this dish, e.g.:

- Suitable shelf position
- Suitable accessory or cookware
- Added liquid
- Time for turning or stirring  
When this time is reached, a signal sounds.

To call up the information, press "Information". Some notifications are displayed automatically.

#### Programmes

The optimum type of heating, temperature and cooking time are preset for programmes.

To achieve an optimal cooking result, you must also set the weight, thickness or the cooking level. You can set the weight only in the intended range. Unless otherwise indicated, set the total weight for your dish.

#### Recommended settings

For the recommended settings, the optimum type of heating is preset as a fixed value. You can adjust the set temperature and the cooking time.

### 10.3 Overview of the dishes

You can see which individual dishes are available to you here. The dishes depend on the features of your appliance.

**Note:** In the basic settings, you can regionally specialise the displayed dishes.

→ "Basic settings", Page 15

Dishes

- Pavlova
- Muffins
- Scones
- Part-cooked bread rolls or baguette
- Bake, savoury, fresh, cooked ingredients
- Potato gratin, raw ingredients, 4 cm deep
- Lasagne, fresh
- Fruit crumble
- Chicken, halved
- Chicken pieces
- Duck, unstuffed
- Goose legs
- Small turkey, unstuffed
- Turkey breast
- Turkey, crown - British style
- Boned pork neck joint
- Joint of pork with crackling, e.g. shoulder
- Pork tenderloin steak
- Pork loin joint - British style
- Pork roast joint - British style
- Pork belly - British style
- Sirloin, rare
- Sirloin, medium
- Pot-roasted beef
- Beef slow roast joint - British style
- Beef top side, top rump - British style
- Joint of veal, marbled
- Joint of veal, lean
- Leg of lamb on the bone, well done
- Boned leg of lamb, medium
- Lamb shoulder, boned and rolled - British style
- Meat loaf made from fresh mince
- Veal Ossobuco
- Meat stew
- Roast fish, whole
- Pizza, frozen, with thin base, x 1
- Pizza, frozen, with deep-pan base, x 1
- Chips, frozen
- Baked potatoes, whole
- Stew with vegetables

### 10.4 Setting a dish

1. Press "Dishes".

2. Press the required dish.

**Note:** The setting options vary depending on the dish.

→ "Setting options for the dishes", Page 13

✓ The settings for the dish appear on the display.

3. Adjust the settings if required.

The setting options vary depending on the dish.

→ "Setting options for the dishes", Page 13

4. For information about the accessory and shelf position, for example, press "Information".

5. Press  $\triangleright$  to start the operation.

✓ The appliance starts to heat and the time counts down.

✓ Once the dish is ready, a signal sounds. The appliance stops heating.

6. Decide how you want to continue:

End	Dish is ready
-----	---------------

---

Add extra cooking time	→ "Extending the cooking time", Page 14
------------------------	---

---

Keep warm	→ "Keeping a dish warm", Page 14
-----------	----------------------------------

---

## 10.5 Extending the cooking time

1. To extend the cooking time, press "Add extra cooking time".
2. Use the  $\langle$  or  $\rangle$  button to change the settings, if required.
3. Press ✓ to confirm the settings.

## 10.6 Keeping a dish warm

1. To keep the dish warm, press "Keep warm".
2. Use the  $\langle$  or  $\rangle$  button to change the settings, if required.
3. Press ✓ to confirm the settings.
4. Press  $\triangleright$  to start the keep warm function.

# 11 Favourites

In the "Favourites", you can save your settings and use these again.

## Notes

- Depending on the appliance type/software status, you must first download this function to your appliance. You can find more information in the Home Connect app.
- You can start the favourites on the appliance or using the Home Connect app. All other functions are available via the Home Connect app.

## 11.1 Saving favourites

You can save up to 10 different functions as your favourites.

- ▶ To save a function as a favourite, you must use the Home Connect app. When your appliance is connected, follow the instructions in the app.

## 11.2 Selecting favourites

If you have saved favourites, you can use these to set the operation.

1. Press "Favourites".
2. Press the required favourites.
3. If required, you can change the settings.
4. Press  $\triangleright$  to start the operation.

## 11.3 Changing favourites

You can change, sort or delete your saved favourites at any time.

- ▶ To change the favourites, you must use the Home Connect app. When your appliance is connected, follow the instructions in the app.

# 12 Childproof lock

You can secure your appliance to prevent children from accidentally switching it on or changing the settings.

## 12.1 Activating the childproof lock

The childproof lock disables the control panel to prevent children from accidentally switching on the appliance. To switch on the appliance, deactivate the childproof lock.

**Note:** When you activate the childproof lock, the appliance will immediately disable the control panel. The  $\odot$  button is the exception and will not be disabled.

1. Press  $\vdots$ .
  2. Press  $\infty$ .
- ✓ "Childproof lock activated" appears on the display.

## 12.2 Deactivating the childproof lock

- ▶ Press and hold "Unlock" until "Childproof lock deactivated" appears.



## 13 Rapid heating



With the rapid heating function, you can shorten the heat-up time.

From 200 °C, the rapid heating function is activated automatically.

**Note:** You can deactivate automatic rapid heating from 200 °C in the basic settings.

→ "Basic settings", Page 15



Rapid heating is possible for the following types of heating:

- "Circo Therm hot air" 
- "Top/bottom heat" 
- "Bread baking setting" 



### 13.1 Activating the "Rapid heat-up" function

To ensure an even cooking result, do not place the food in the cooking compartment until rapid heating has come to an end.

**Note:** Do not set a cooking time until rapid heating has come to an end.

1. Set a suitable type of heating and a temperature of at least 100 °C.  
Rapid heating automatically switches off at temperatures of 200 °C and above.
2. Press .
3. Press  to start the operation.
- ✓ Once rapid heating has ended, "Rapid heating" switches off automatically and a signal sounds.  goes out on the display.
4. Place the food in the cooking compartment.

### 13.2 Deactivating the "Rapid heat-up" function

1. Press .
2. Press .

## 14 Basic settings

You can configure the basic settings for your appliance to meet your needs.

### 14.1 Overview of the basic settings

Here you can find an overview of the basic settings and factory settings. The basic settings depend on the features of your appliance.

You can find more information about the individual basic settings on the display using "Information".

Basic settings	Selection
Language	See selection on the appliance
Home Connect	Connect the oven to a mobile end device and remotely control it → "Home Connect", Page 16
Time	Time in 24-hour format
Date	Date in the format DD.MM.YYYY

Display	Selection
Brightness	<ul style="list-style-type: none"> <li>■ 1</li> <li>■ 2</li> <li>■ 3</li> <li>■ 4</li> <li>■ 5<sup>1</sup></li> </ul>
Standby screen	<ul style="list-style-type: none"> <li>■ On for a limited time</li> <li>■ On (this setting increases energy consumption)</li> <li>■ Off<sup>1</sup></li> </ul>
Clock	<ul style="list-style-type: none"> <li>■ Digital + date<sup>1</sup></li> <li>■ Digital</li> <li>■ Analogue + date</li> <li>■ Analogue</li> </ul>
Adjustment	Align the display horizontally and vertically

<sup>1</sup> Factory setting (may vary according to model)

Sound	Selection
Button tone	<ul style="list-style-type: none"> <li>■ On<sup>1</sup></li> <li>■ Off</li> </ul>
Signal tone	<ul style="list-style-type: none"> <li>■ Very short duration</li> <li>■ Short duration</li> <li>■ Medium duration<sup>1</sup></li> <li>■ Long duration</li> </ul>

<sup>1</sup> Factory setting (may vary according to model)

Appliance settings	Selection
Fan run-on time	<ul style="list-style-type: none"> <li>■ Minimum</li> <li>■ Recommended<sup>1</sup></li> <li>■ Long</li> <li>■ Very long</li> </ul>
Pull-out system	<ul style="list-style-type: none"> <li>■ Retrofitted (if 2 or 3 sets of pull-out rails are fitted)</li> <li>■ Not retrofitted (if shelf supports and a single set of pull-out rails are fitted)<sup>1</sup></li> </ul>
Illumination	<ul style="list-style-type: none"> <li>■ On when cooking and opening the door<sup>1</sup></li> <li>■ Only when the door is opened</li> <li>■ Always off</li> </ul>

<sup>1</sup> Factory setting (may vary according to model)







Personalisation	Selection
Brand logo	<ul style="list-style-type: none"> <li>■ Display<sup>1</sup></li> <li>■ Do not display</li> </ul>
Operation after switch-on	<ul style="list-style-type: none"> <li>■ Main menu<sup>1</sup></li> <li>■ Types of heating</li> <li>■ Dishes</li> <li>■ Favourites</li> </ul>

<sup>1</sup> Factory setting (may vary according to model)

Personalisation	Selection
Elapsed cooking time	<ul style="list-style-type: none"> <li>■ Display<sup>1</sup></li> <li>■ Do not display</li> </ul>
Regional dishes	<ul style="list-style-type: none"> <li>■ All<sup>1</sup></li> <li>■ European dishes</li> <li>■ British dishes</li> </ul>
Dishes	<ul style="list-style-type: none"> <li>■ All<sup>1</sup></li> <li>■ No pork</li> <li>■ Kosher only</li> </ul>
Childproof lock	<ul style="list-style-type: none"> <li>■ Available<sup>1</sup></li> <li>■ Deactivated</li> </ul>
Automatic rapid heating	<ul style="list-style-type: none"> <li>■ On<sup>1</sup></li> <li>■ Off</li> </ul>
<sup>1</sup> Factory setting (may vary according to model)	
Factory settings	Selection
Factory settings	<ul style="list-style-type: none"> <li>■ Cancel</li> <li>■ Restore</li> </ul>

Appliance information	Display
Appliance information	Display technical information about the appliance

## 14.2 Changing basic settings

1. Press  to switch the appliance on.
2. Press "Basic settings".
3. Use  or  to scroll through the basic settings or categories.
4. Press the required basic setting or category.
  - Press the required basic setting in a category.
5. Swipe left or right to select the required setting.
6. Press  to confirm the change. If  does not appear, the change is applied immediately.
7. To change other basic settings, use  to return to the basic settings.

# 15 Home Connect

This appliance is network-capable. Connecting your appliance to a mobile device lets you control its functions via the Home Connect app, adjust its basic settings and monitor its operating status.

The Home Connect services are not available in every country. The availability of the Home Connect function depends on the availability of Home Connect services in your country. You can find information about this at: [www.home-connect.com](http://www.home-connect.com).

The Home Connect app guides you through the entire login process. Follow the instructions in the Home Connect app to configure the settings.

### Tips

- Please consult the documents supplied by Home Connect.
- Please also follow the instructions in the Home Connect app.

### Notes

- Please note the safety precautions in this instruction manual and make sure that they are also observed when operating the appliance via the Home Connect app.
  - "Safety", Page 2
- Operating the appliance on the appliance itself always takes priority. During this time it is not possible to operate the appliance using the Home Connect app.
- In networked standby mode, the appliance requires a maximum of 2 W.

## 15.1 Setting up Home Connect

### Requirements

- The appliance is connected to the power supply and is switched on.
- You have a mobile device with a current version of the iOS or Android operating system, e.g. a smartphone.
- The mobile device and the appliance are within range of your home network's Wi-Fi signal.

1. Download the Home Connect app.



2. Open the Home Connect app and scan the following QR code.



3. Follow the instructions in the Home Connect app.

## 15.2 Home Connect settings

You can adjust the Home Connect settings and network settings in your appliance's basic settings. Which settings the display shows will depend on whether Home Connect has been set up and whether the appliance is connected to your home network.

Basic setting	Possible settings	Explanation
Home Connect assistant	Start the assistant Disconnect	You can connect your appliance to the Home Connect app via the Home Connect assistant. <b>Note:</b> If you are using the Home Connect assistant for the first time, only the "Start assistant" setting is available.
Wi-Fi	On Off	You can use the Wi-Fi to switch off the network connection for your appliance. When you have connected successfully once, you can deactivate the Wi-Fi and not lose your detailed data. As soon as you activate Wi-Fi again, the appliance connects automatically. <b>Note:</b> In networked standby mode, the appliance requires a maximum of 2 W.
Remote control status	Monitoring Manual remote start Permanent remote start	During monitoring, you can only view the operating status of the appliance in the app. For manual remote start, you must activate the remote start each time before you can start the appliance via the app. If you open the appliance door within 15 minutes of activating remote start or of the operation ending, remote start is deactivated. For permanent remote start, you can start and operate the appliance remotely at any time. If you often operate the appliance remotely, it is helpful to set the remote start to "Permanent".

### 15.3 Operating the appliance with the Home Connect app

You can use the Home Connect app to set and start the appliance remotely.

#### **WARNING – Risk of fire!**

Combustible objects that are left in the cooking compartment may catch fire.

- ▶ Never store combustible objects in the cooking compartment.
- ▶ If smoke is emitted, the appliance must be switched off or the plug must be pulled out and the door must be held closed in order to stifle any flames.

#### **Requirements**

- The appliance is switched on.
- The appliance is connected to the home network and to the Home Connect app.
- In order to be able to set the appliance via the app, the manual or permanent remote start must be selected in the "Remote control status" basic setting.

1. To activate remote start, press .
2. Configure a setting in the Home Connect app and send it to the appliance.

#### **Notes**

- If you open the appliance door within 15 minutes of activating remote start or of the operation ending, the manual remote start is deactivated.
- When you start the oven using the controls on the appliance itself, the remote start function is activated automatically. You can use the Home Connect app to adjust the settings or start a new programme.

### 15.4 Software update

Your appliance's software can be updated using the software update function, e.g. for the purposes of optimisation, troubleshooting or security updates. To do this, you must be a registered Home Connect user, have installed the app on your mobile device and be connected to the Home Connect server. As soon as a software update is available, you will be informed via the Home Connect app and will be able to start the software update via the app. Once the update has been successfully downloaded, you can start installing it via the Home Connect app if you are in your WLAN home network (Wi-Fi). The Home Connect app will inform you once installation is successful.

#### **Notes**

- You can continue to use your appliance as normal while updates are downloading. Depending on your personal settings in the app, software updates can also be set to download automatically.
- We recommend that you install security updates as soon as possible.
- Installation takes a few minutes. You cannot use your appliance during installation.

### 15.5 Remote diagnostics

Customer Service can use Remote Diagnostics to access your appliance if you contact them, have your appliance connected to the Home Connect server and if Remote Diagnostics is available in the country in which you are using the appliance.

**Tip:** For further information and details about the availability of Remote Diagnostics in your country, please visit the service/support section of your local website: [www.home-connect.com](http://www.home-connect.com).

## 15.6 Data protection

Please see the information on data protection. The first time your appliance is registered on a home network connected to the Internet, your appliance will transmit the following types of data to the Home Connect server (initial registration):

- Unique appliance identification (consisting of appliance codes as well as the MAC address of the Wi-Fi communication module installed).
- Security certificate of the Wi-Fi communication module (to ensure a secure data connection).

- The current software and hardware version of your appliance.
- Status of any previous reset to factory settings.

This initial registration prepares the Home Connect functions for use and is only required when you want to use the Home Connect functions for the first time.

**Note:** Please note that the Home Connect functions can only be utilised with the Home Connect app. Information on data protection can be retrieved in the Home Connect app.

# 16 Cleaning and servicing

To keep your appliance working efficiently for a long time, it is important to clean and maintain it carefully.

## 16.1 Cleaning products

In order to avoid damaging the various oven surfaces on the appliance, do not use unsuitable cleaning products.

### **WARNING – Risk of electric shock!**

An ingress of moisture can cause an electric shock.

- ▶ Do not use steam- or high-pressure cleaners to clean the appliance.

### **ATTENTION!**

Unsuitable cleaning agents damage the surfaces of the appliance.

- ▶ Do not use harsh or abrasive cleaning products.
- ▶ Do not use cleaning products with a high alcohol content.

- ▶ Do not use hard scouring pads or cleaning sponges.
- ▶ Do not use any special cleaners for cleaning the appliance while it is hot.

Using oven cleaner in a hot cooking compartment damages the enamel.

- ▶ Never use oven cleaner in the cooking compartment when it is still warm.
- ▶ Remove all food remnants from the cooking compartment and the appliance door before you next heat up the appliance.

If different cleaning agents are mixed together, there may be a chemical reaction between these.

- ▶ Do not mix cleaning agents.
- ▶ Completely remove any cleaning agent residue. Salt contained in new sponge cloths may damage surfaces.
- ▶ Wash new sponge cloths thoroughly before use.

## Suitable cleaning agents

Only use cleaning agents that are suitable for the different surfaces on your appliance.

Follow the instructions on cleaning the appliance. → "Cleaning the appliance", Page 19

### Appliance front

Surface	Suitable cleaning agents	Information
Stainless steel	<ul style="list-style-type: none"> <li>▪ Hot soapy water</li> <li>▪ Special stainless steel cleaning products suitable for hot surfaces</li> </ul>	To prevent corrosion, remove any patches of limescale, grease, starch or albumin (e.g. egg white) from stainless steel surfaces immediately. Apply a thin layer of the stainless steel cleaning product.
Plastic or painted surfaces E.g. control panel	<ul style="list-style-type: none"> <li>▪ Hot soapy water</li> </ul>	Do not use glass cleaner or a glass scraper. To avoid permanent stains, immediately remove any descaling agent that gets onto the surface.

### Appliance door

Area	Suitable cleaning agents	Information
Door panels	<ul style="list-style-type: none"> <li>▪ Hot soapy water</li> <li>▪ Oven cleaners</li> </ul>	Do not use a glass scraper or stainless steel wool. <b>Tip:</b> Remove the door panels in order to clean them thoroughly. → "Appliance door", Page 21
Door cover	<ul style="list-style-type: none"> <li>▪ Made of stainless steel: Stainless steel cleaner</li> <li>▪ Made from plastic: Hot soapy water</li> </ul>	Do not use glass cleaner or a glass scraper. Do not use stainless steel care products. <b>Tip:</b> Remove the door cover for thorough cleaning. → "Appliance door", Page 21



Area	Suitable cleaning agents	Information
Stainless steel interior door frame	<ul style="list-style-type: none"> <li>▪ Stainless steel cleaner</li> </ul>	Discolouration can be removed using stainless steel cleaner. Do not use stainless steel care products.
Door handle	<ul style="list-style-type: none"> <li>▪ Hot soapy water</li> </ul>	To avoid permanent stains, immediately remove any descaling agent that gets onto the surface.
Door seal	<ul style="list-style-type: none"> <li>▪ Hot soapy water</li> </ul>	Do not remove or scrub.

### Cooking compartment

Area	Suitable cleaning agents	Information
Enamel surfaces	<ul style="list-style-type: none"> <li>▪ Hot soapy water</li> <li>▪ Vinegar water</li> <li>▪ Oven cleaners</li> </ul>	Soak any heavily soiled areas and use a brush or steel wool. Leave the appliance door open to dry the cooking compartment after cleaning it. <b>Notes</b> <ul style="list-style-type: none"> <li>▪ Enamel burns at very high temperatures, causing minor discoloration. The functionality of your appliance is not affected by this.</li> <li>▪ The edges of thin trays cannot be completely enamelled and may be rough. This does not impair the corrosion protection.</li> <li>▪ Food residues leave a white coating on the enamel surfaces. The coating does not pose a health risk. The functionality of your appliance is not affected by this. You can remove residues with lemon juice.</li> </ul>
Self-cleaning surfaces	-	Follow the instructions for self-cleaning surfaces. → "Regenerating self-cleaning surfaces in the cooking compartment", Page 19
Shelf supports	<ul style="list-style-type: none"> <li>▪ Hot soapy water</li> </ul>	Soak any heavily soiled areas and use a brush or steel wool. <b>Note:</b> To clean thoroughly, detach the shelf supports. → "Rails", Page 21
Accessories	<ul style="list-style-type: none"> <li>▪ Hot soapy water</li> <li>▪ Oven cleaners</li> </ul>	Soak any heavily soiled areas and use a brush or steel wool. Enamelled accessories are dishwasher-safe.

## 16.2 Cleaning the appliance

In order to avoid damaging the appliance, you must clean your appliance only as specified, and with suitable cleaning products.

### **WARNING – Risk of burns!**

The appliance and its parts that can be touched become hot during use.

- ▶ Caution should be exercised here in order to avoid touching heating elements.
- ▶ Young children under 8 years of age must be kept away from the appliance.

### **WARNING – Risk of fire!**

Loose food remnants, fat and meat juices may catch fire.

- ▶ Before using the appliance, remove the worst of the food residues and remnants from the cooking compartment, heating elements and accessories.

**Requirement:** Read the information on cleaning products.

→ "Cleaning products", Page 18

1. Clean the appliance using hot soapy water and a dish cloth.
  - For some surfaces, you can use alternative cleaning agents.  
→ "Suitable cleaning agents", Page 18
2. Dry with a soft cloth.

## Regenerating self-cleaning surfaces in the cooking compartment

The back panel in the cooking compartment is self-cleaning. The self-cleaning surfaces are coated with a porous, matt ceramic layer and have a rough surface. When the appliance is in operation, the self-cleaning surfaces absorb splashes from baking, roasting or grilling, and break them down. If the self-cleaning surfaces no longer clean themselves adequately during operation, heat up the cooking compartment specifically to the right temperature.

### **ATTENTION!**

If you do not clean the self-cleaning surfaces regularly, they may become damaged.

- ▶ If dark stains are visible on the self-cleaning surfaces, heat up the cooking compartment.
  - ▶ Do not use oven cleaner or abrasive cleaning aids. If oven cleaner accidentally comes into contact with the self-cleaning surfaces, dab it off immediately using water and a sponge cloth. Do not rub.
1. Remove accessories and cookware from the cooking compartment.
  2. Detach the shelf supports and remove them from the cooking compartment.  
→ "Rails", Page 21
  3. Remove coarse dirt using soapy water and a soft cloth:
    - From the smooth enamel surfaces
    - From the inside of the appliance door
    - From the glass cover on the oven lamp

- This prevents stains that cannot be removed.
4. Remove any objects from the cooking compartment. The cooking compartment must be empty.
  5. Set the bread-baking setting.
  6. Set the maximum temperature.
  7. Start the operation.
  8. Switch off the appliance after 1 hour.
  9. Once the appliance has cooled down, wipe the cooking compartment with a damp cloth.

- Note:** Marks may appear on the self-cleaning surfaces. Residues of sugar and egg white in the food are not removed and stick to the surfaces. Red stains are residues from salty food – they are not rust. The stains are not hazardous to health. These marks do not impair the cleaning ability of the self-cleaning surfaces.
10. Attach the shelf supports.  
→ "Rails", Page 21

---

## 17 "Easy Clean" cleaning aid

Use the "Easy Clean" cleaning aid for intermediate cleaning of the cooking compartment. The "Easy Clean" cleaning aid softens dirt by vaporising the soapy water. It is then easier to remove the dirt.

### 17.1 Setting the "Easy Clean" cleaning aid

#### **WARNING – Risk of scalding!**

If there is water in the cooking compartment when it is hot, this may create hot steam.

- ▶ Never pour water into the cooking compartment when the cooking compartment is hot.

#### **Notes**

- The oven light does not light up while the cleaning aid is running.
- Do not open the appliance door while the appliance is in operation.

#### **Requirements**

- You can only start the cleaning aid once the cooking compartment is cold (room temperature) and the appliance door is closed.
- To remove particularly stubborn dirt, rub washing-up liquid onto dirty areas on the smooth surfaces before starting the cleaning aid.

1. Remove any accessories from the cooking compartment.

2. **ATTENTION!**

Distilled water in the cooking compartment leads to corrosion.

- ▶ Do not use distilled water.

Mix 0.4 litres water with a drop of washing-up liquid and pour into the centre of the cooking compartment floor.

3. Press "Cleaning".
4. Press "Easy Clean".

5. Press  to start the cleaning aid.
  - ✓ A notification stating that you should carry out the necessary preparatory work for the cleaning aid appears on the display.
6. Press "OK" to confirm the notification.
  - ✓ The cleaning aid starts. The duration counts down on the display.
  - ✓ Once the cleaning aid has run through to the end, an audible signal sounds.
7. Press any button to end the audible signal.
8. After using the cleaning aid, finish cleaning the cooking compartment.

### 17.2 Wiping down the cooking compartment

#### **ATTENTION!**

The prolonged presence of moisture in the cooking compartment leads to corrosion.

- ▶ After using the cleaning aid, wipe the cooking compartment clean and allow it to dry fully.

**Requirement:** The cooking compartment must have cooled down.

1. Open the appliance door and remove the remaining water with an absorbent sponge cloth.
2. Clean the smooth surfaces in the cooking compartment with a dish cloth or a soft brush. Remove stubborn food remnants using a stainless steel scouring pad.
3. Remove limescale with a cloth soaked in vinegar. Then wipe with clean water and rub dry with a soft cloth (including under the door seal).
4. If there is any stubborn dirt that you are unable to remove, run the cleaning aid again once the cooking compartment has cooled down.
5. In order to dry the cooking compartment, leave the appliance door open in the detent position (approx. 30°) for around 1 hour or use the drying function.

---

## 18 Drying

### 18.1 Drying the cooking compartment

#### **WARNING – Risk of burns!**

The appliance becomes hot during operation.

- ▶ Allow the appliance to cool down before cleaning.

#### **ATTENTION!**

If there is water on the cooking compartment floor when operating the appliance at temperatures above 120 °C, this will damage the enamel.

- ▶ Do not use the appliance if there is water on the cooking compartment floor.
- ▶ Wipe away any water on the cooking compartment floor before operation.

**Requirement:** The cooking compartment has cooled down.

1. Remove any food remnants from the cooking compartment.
2. Dry the cooking compartment with a sponge.
3. Remove limescale marks with a cloth soaked in vinegar, then wipe with clean water and dry with a soft cloth.
4. Leave the cooking compartment to dry with the appliance door open for 1 hour or use "Drying function".  
→ "Setting 'Drying function'", Page 21

## 18.2 Setting "Drying function"

**Requirement:** → "Drying the cooking compartment", Page 20

1. Press "Cleaning".
2. Press "Drying function".
  - ✓ The duration appears on the display. You cannot change the duration of the drying function.
3. Start the drying function using  $\triangleright$ ||.
  - ✓ A notification stating that you should carry out the necessary preparatory work for the drying function appears on the display.
4. Press "OK" to confirm the notification.
  - ✓ The drying function starts. The duration counts down on the display.
  - ✓ Once the drying function has run through to the end, an audible signal sounds.
5. Leave the appliance door open for 1-2 minutes so that the cooking compartment dries completely.

# 19 Rails

To thoroughly clean the rails and the cooking compartment, or to replace the rails, you can remove the rails.

## 19.1 Detaching the rails

### **WARNING – Risk of burns!**

The shelf supports get very hot

- ▶ Never touch the shelf supports when hot.
- ▶ Always allow the appliance to cool down.
- ▶ Keep children at a safe distance.

1. Lift the rail forwards slightly ① and detach it ②.
2. Pull the whole rail to the front ③ and remove it.

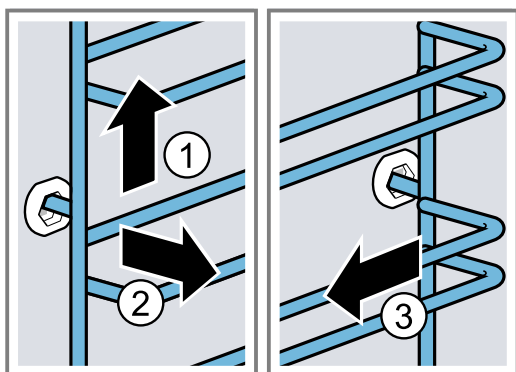

3. Clean the rail.

## 19.2 Attaching the rails

### Notes

- The rails only fit on the right or left.
- For both rails, ensure that the curved rods are at the front.

1. First, push the rail into the middle of the rear socket ① until the rail rests against the cooking compartment wall, and then push this back ②.
2. Push the rail into the front socket ③ until the rail also rests against the cooking compartment wall, and then press this downwards ④.

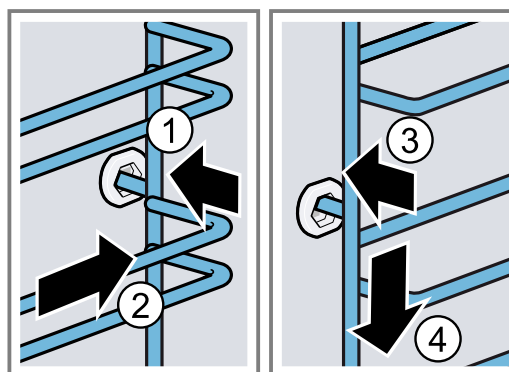

# 20 Appliance door

To clean the appliance door thoroughly, you can disassemble the appliance door.

## 20.1 Detaching the appliance door

### **WARNING – Risk of injury!**

Components inside the appliance door may have sharp edges.

- ▶ Wear protective gloves.

The hinges on the appliance door move when the door is opened and closed, which could trap your fingers.

- ▶ Keep your hands away from the hinges.

1. Open the appliance door fully.

**2. ⚠ WARNING – Risk of injury!**

When the hinges are not secured, they can snap shut with great force.

- ▶ Make sure that the locking levers are always either fully closed or (when detaching the oven door) fully open.

Open the locking levers on the left- and right-hand hinges.

Locking levers opened

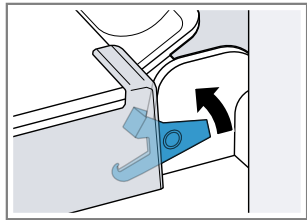

The hinge is now secured and cannot snap shut.

Locking levers closed

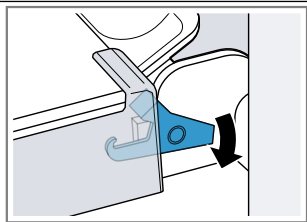

The appliance door is secured and cannot be detached.

- ✓ The locking levers are open. The hinges are now secured and cannot snap shut.
- 3.** Close the appliance door fully ①. Grab hold of the appliance door with both hands (on the left and right) and pull it upwards and out ②.

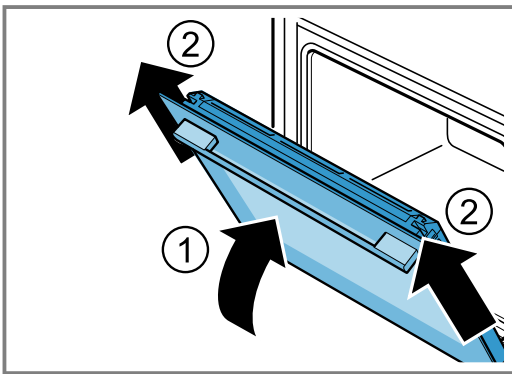

- 4.** Carefully place the appliance door on a level surface.

**20.2 Attaching the appliance door**

**⚠ WARNING – Risk of injury!**

The hinges on the appliance door move when the door is opened and closed, which could trap your fingers.

- ▶ Keep your hands away from the hinges.
- When the hinges are not secured, they can snap shut with great force.
- ▶ Make sure that the locking levers are always either fully closed or (when detaching the oven door) fully open.

1. Slide the appliance door straight onto the two hinges ①. Slide the appliance door on as far as it will go.
2. Open the appliance door fully.
3. Close the locking levers on the left- and right-hand hinges ②.

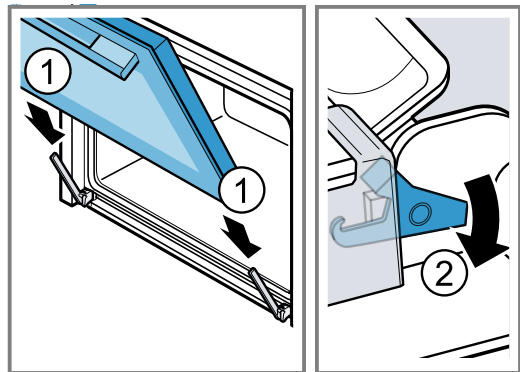

- ✓ The locking levers are closed. The appliance door is secured and cannot be detached.
- 4.** Close the appliance door.

**20.3 Removing the door panes**

**⚠ WARNING – Risk of injury!**

The hinges on the appliance door move when the door is opened and closed, which could trap your fingers.

- ▶ Keep your hands away from the hinges.
- Components inside the appliance door may have sharp edges.
- ▶ Wear protective gloves.

1. Open the appliance door fully.
  2. Open the locking levers on the left- and right-hand hinges ①.
- ✓ The locking levers are open. The hinges are now secured and cannot snap shut.
- 3.** Close the appliance door fully ②.

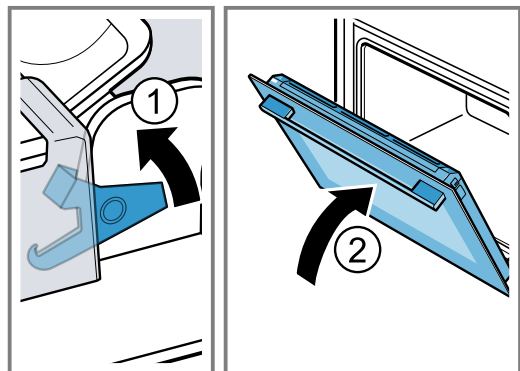

- 4.** Push on the left- and right-hand side of the door cover from the outside ① until it is released.



5. Remove the door cover ②.

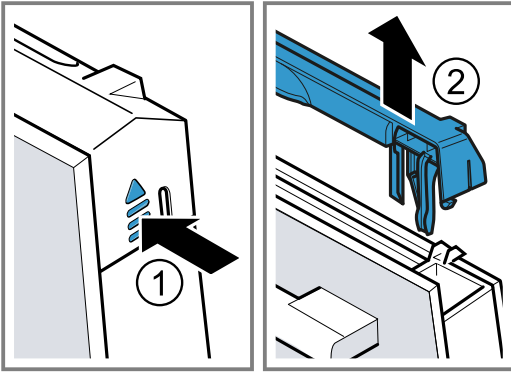

6. Lift out the inner pane ① and set it down carefully on a flat surface.  
7. Lift out the intermediate pane ② and set it down carefully on a flat surface.

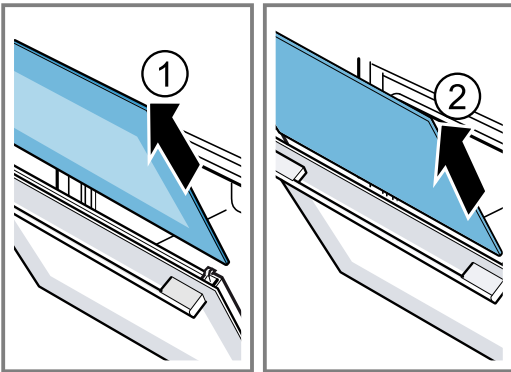

8. Open the appliance door and remove the door seal.

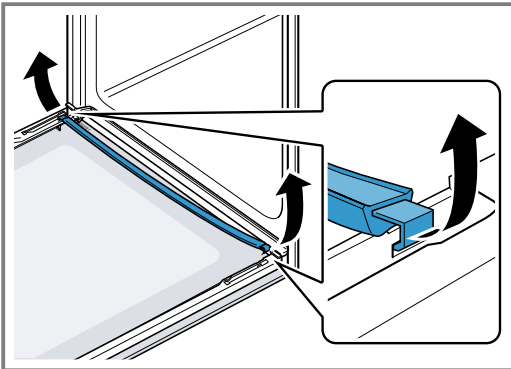

9. If necessary, you can remove the condensate trough for cleaning.  
– Open the appliance door.  
– Tilt the condensate trough upwards and remove it.

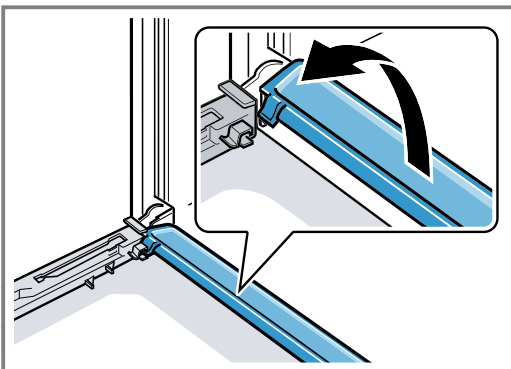

10. **⚠ WARNING – Risk of injury!**

Scratched glass in the appliance door may develop into a crack.

- ▶ Do not use any harsh or abrasive cleaners or sharp metal scrapers to clean the glass on the oven door, as they may scratch the surface.

Clean the removed door panels on both sides with glass cleaner and a soft cloth.

11. Clean the condensate trough with a cloth and hot soapy water.  
12. Clean the appliance door.  
13. Dry the door panels and refit them.

## 20.4 Fitting the door panes

- ⚠ WARNING – Risk of injury!**

The hinges on the appliance door move when the door is opened and closed, which could trap your fingers.

- ▶ Keep your hands away from the hinges.
- Components inside the appliance door may have sharp edges.

- ▶ Wear protective gloves.

1. Open the appliance door fully.
2. Place the condensate trough vertically into the retainer **a** and turn it downwards.

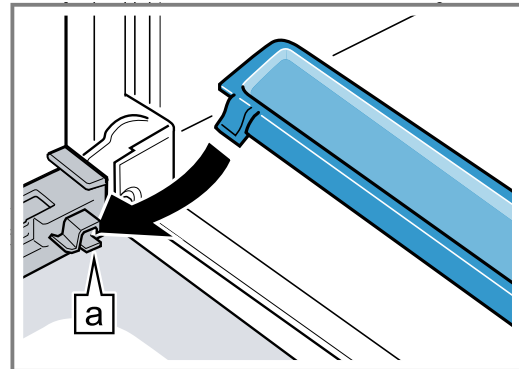

3. Slide the intermediate pane into the left- and right-hand retainers **a**.

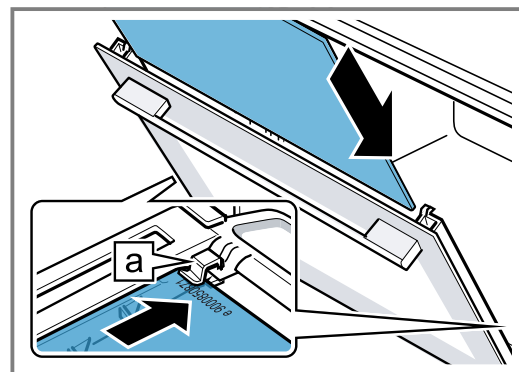

4. Push the intermediate pane upwards until it is in the left- and right-hand retainers [a].

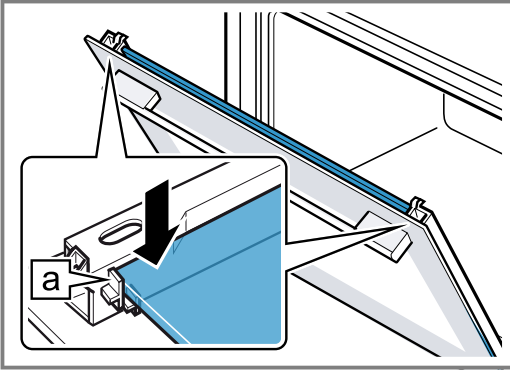

5. Open the appliance door and attach the door seal.

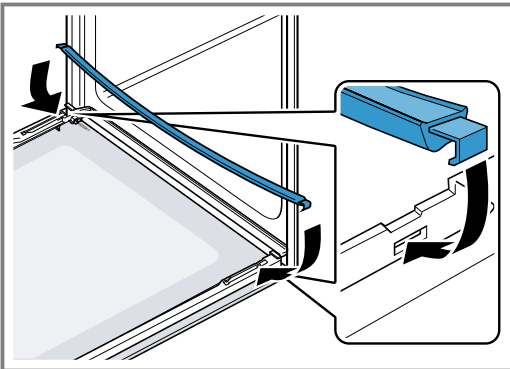

6. **Note:** When sliding the pane in, ensure that the glossy side of the pane is on the outside and the cut-outs on the left and right are at the top. Slide the inner pane into the left- and right-hand retainers [a].

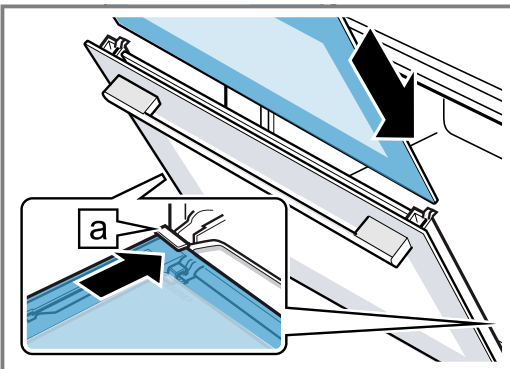

7. Push the inner pane upwards until it is in the left- and right-hand retainers [a].

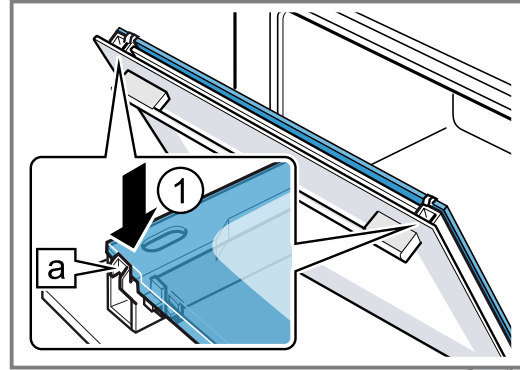

8. Put the door cover into position ① and push down on it until you hear it click into place.  
9. Open the appliance door fully.  
10. Close the locking levers on the left- and right-hand hinges ②.

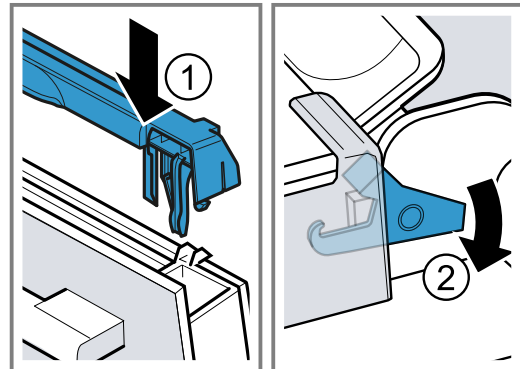

- ✓ The locking levers are closed. The appliance door is secured and cannot be detached.

11. Close the appliance door.

**Note:** Do not use the cooking compartment again until the door panes have been correctly fitted.

## 21 Troubleshooting

You can rectify minor faults on your appliance yourself. Read the troubleshooting information before contacting after-sales service. This will avoid unnecessary costs.

### **⚠ WARNING – Risk of injury!**

Improper repairs are dangerous.



- ▶ Repairs to the appliance should only be carried out by trained specialist staff.
- ▶ If the appliance is defective, call Customer Service.

### **⚠ WARNING – Risk of electric shock!**

Incorrect repairs are dangerous.

- ▶ Repairs to the appliance should only be carried out by trained specialist staff.
- ▶ Only use genuine spare parts when repairing the appliance.
- ▶ If the power cord of this appliance is damaged, it must be replaced by trained specialist staff.

## 21.1 Malfunctions

Fault	Cause and troubleshooting
The appliance is not working.	The circuit breaker in the fuse box has tripped. <ul style="list-style-type: none"> <li>▶ Check the circuit breaker in the fuse box.</li> </ul> <hr/> There has been a power cut. <ul style="list-style-type: none"> <li>▶ Check whether the lighting in your kitchen or other appliances are working.</li> </ul> <hr/> Electronics fault <ol style="list-style-type: none"> <li>1. Disconnect the appliance from the power supply for at least 30 seconds by switching off the fuse.</li> <li>2. Reset the basic settings to the factory settings. → <i>"Basic settings", Page 15</i></li> </ol>
"Sprache Deutsch" appears in the display.	There has been a power cut. <ul style="list-style-type: none"> <li>▶ Configure the initial configuration settings. → <i>"Initial use", Page 10</i></li> </ul>
The operation does not start or is interrupted.	Different causes are possible. <ul style="list-style-type: none"> <li>▶ Check the notifications that appear on the display. → <i>"Displaying information", Page 11</i></li> </ul> <hr/> Malfunction <ul style="list-style-type: none"> <li>▶ Call the after-sales service. → <i>"Customer Service", Page 26</i></li> </ul>
Appliance does not heat up.	Demo mode is switched on. <ol style="list-style-type: none"> <li>1. Disconnect the appliance from the power supply for at least 30 seconds by switching off the fuse.</li> <li>2. Switch off demo mode in the basic settings within approx. 5 minutes. → <i>"Changing basic settings", Page 16</i></li> </ol> <hr/> There has been a power cut. <ul style="list-style-type: none"> <li>▶ Open and close the appliance door once after a power failure.</li> <li>✓ The appliance is checked and is ready to use.</li> </ul>
The time is not displayed when the appliance is switched off.	Basic setting has been changed. <ul style="list-style-type: none"> <li>▶ Change the basic setting for the clock. → <i>"Basic settings", Page 15</i></li> </ul>
Home Connect is not working properly.	Different causes are possible. <ul style="list-style-type: none"> <li>▶ Go to <a href="http://www.home-connect.com">www.home-connect.com</a>.</li> </ul>
The interior lighting does not work.	Basic setting has been changed. <ul style="list-style-type: none"> <li>▶ Change the basic setting for the lighting. → <i>"Basic settings", Page 15</i></li> </ul> <hr/> The LED light is defective. <ul style="list-style-type: none"> <li>▶ Call the after-sales service. → <i>"Customer Service", Page 26</i></li> </ul>
A notification appears on the display confirming that the maximum operating time has been reached.	The maximum operating time has been reached. The appliance stops heating. <ol style="list-style-type: none"> <li>1. Press "OK" to confirm the notification about the maximum operating time.</li> <li>2. Check whether you still need the appliance.</li> </ol> <ul style="list-style-type: none"> <li>▶ Set a cooking time so that the operation does not stop. → <i>"Time-setting options", Page 12</i></li> </ul>
The operation stops.	The maximum operating time has been reached. The appliance stops heating. <ol style="list-style-type: none"> <li>1. Press  to switch off the appliance.</li> <li>2. If necessary, press  to switch the appliance back on and then restart the operation.</li> </ol> <ul style="list-style-type: none"> <li>▶ Set a cooking time so that the operation does not stop. → <i>"Time-setting options", Page 12</i></li> </ul>
Error code made up of letters and numbers appears on the display, e.g. E0111.	The electronics have detected a fault. <ol style="list-style-type: none"> <li>1. Switch the appliance off and on again.</li> <li>✓ If the fault was a one-off, the message disappears.</li> <li>2. If the message appears again, call the after-sales service. Please specify the exact error message when calling. → <i>"Customer Service", Page 26</i></li> </ol>

Fault	Cause and troubleshooting
The cooking result is not satisfactory.	Settings were unsuitable. Adjustment values, e.g. temperature or cooking time, depend on the recipe, quantity and food. ▶ Next time, set lower or higher values. <b>Tip:</b> A lot of other information about the food preparation and corresponding adjustment values can be found in the Home Connect app or on our website <a href="http://www.neff-international.com">www.neff-international.com</a> .

## 22 Disposal

### 22.1 Disposing of old appliance

Valuable raw materials can be reused by recycling.

1. Unplug the appliance from the mains.
2. Cut through the power cord.
3. Dispose of the appliance in an environmentally friendly manner.  
Information about current disposal methods are available from your specialist dealer or local authority.



This appliance is labelled in accordance with European Directive 2012/19/EU concerning used electrical and electronic appliances (waste electrical and electronic equipment - WEEE). The guideline determines the framework for the return and recycling of used appliances as applicable throughout the EU.

## 23 Customer Service

Function-relevant genuine spare parts according to the corresponding Ecodesign Order can be obtained from Customer Service for a period of at least 10 years from the date on which your appliance was placed on the market within the European Economic Area.

**Note:** Under the terms of the manufacturer's warranty the use of Customer Service is free of charge.

Detailed information on the warranty period and terms of warranty in your country is available from our after-sales service, your retailer or on our website.

If you contact Customer Service, you will require the product number (E-Nr.), the production number (FD) and the consecutive numbering (Z-Nr.) of your appliance.

The contact details for Customer Service can be found in the enclosed Customer Service directory or on our website.

This product contains light sources from energy efficiency class G. These light sources are available as a spare part and should only be replaced by trained specialist staff.

### 23.1 Product number (E-Nr.), production number (FD) and consecutive numbering (Z-Nr.)

You can find the product number (E-Nr.), the production number (FD) and the consecutive numbering (Z-Nr.) on the appliance's rating plate. You will see the rating plate with these numbers if you open the appliance door.

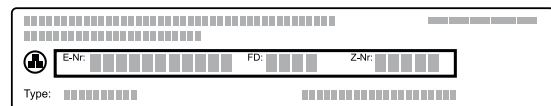

Make a note of your appliance's details and the Customer Service telephone number to find them again quickly.

You can also display the appliance information in the basic settings.

→ "Basic settings", Page 15

## 24 Information regarding Free and Open Source Software

This product includes software components that are licensed by the copyright holders as free or open source software.

The applicable licence information is stored on your home appliance. You can also access the applicable licence information via your Home Connect app: "Profile -> Legal information -> Licence Information".<sup>1</sup> You can download the licence information on the brand product website. (Please search on the product website for your appliance model and additional documents). Al-

ternatively, you can request the relevant information from [ossrequest@bshg.com](mailto:ossrequest@bshg.com) or BSH Hausgeräte GmbH, Carl-Wery-Str. 34, 81739 Munich, Germany.

The source code will be made available to you on request.

Please send your request to [ossrequest@bshg.com](mailto:ossrequest@bshg.com) or BSH Hausgeräte GmbH, Carl-Wery-Str.34, 81739 Munich, Germany.

Subject: „OSSREQUEST“

<sup>1</sup> Depending on the appliance specifications



The cost of performing your request will be charged to you. This offer is valid for three years from the date of purchase or at least as long as we offer support and spare parts for the relevant appliance.

## 25 Declaration of Conformity

BSH Hausgeräte GmbH hereby declares that the appliance with Home Connect functionality conforms to the essential requirements and other relevant provisions of Directive 2014/53/EU.

A detailed RED Declaration of Conformity can be found online at [www.neff-international.com](http://www.neff-international.com) among the additional documents on the product page for your appliance.



Hereby, BSH Hausgeräte GmbH declares that the appliance with Home Connect functionality is in compliance with relevant statutory requirements.<sup>1</sup>

A detailed Declaration of Conformity can be found online at [www.neff-home.com/uk](http://www.neff-home.com/uk) among the additional documents on the product page for your appliance.<sup>1</sup>



Only applies to Great Britain

2.4 GHz band (2400–2483.5 MHz): Max. 100 mW

	BE	BG	CZ	DK	DE	EE	IE	EL	ES
	FR	HR	IT	CY	LI	LV	LT	LU	HU
	MT	NL	AT	PL	PT	RO	SI	SK	FI
	SE	NO	CH	TR	IS	UK (NI)			

5 GHz WLAN (Wi-Fi): For indoor use only.

AL	BA	MD	ME	MK	RS	UK	UA
----	----	----	----	----	----	----	----

5 GHz WLAN (Wi-Fi): For indoor use only.

## 26 How it works

Here, you can find the ideal settings for various types of food as well as the best accessories and cookware. We have perfectly tailored these recommendations to your appliance.

**Tip:** A lot of other information about the food preparation and corresponding adjustment values can be found in the Home Connect app or on our website [www.neff-international.com](http://www.neff-international.com).

### 26.1 General cooking tips

Take note of the following information when cooking all types of food.

- The temperature and cooking time depend on the amount of food and the recipe. Settings ranges are specified for this reason. Try using the lower values to start with.
- The setting values apply to food placed in the cooking compartment while the cooking compartment is still cold. If you want to preheat anyway, do not place accessories into the cooking compartment until it has finished preheating.
- Remove any accessories that are not being used from the cooking compartment.

### 26.2 Baking tips

- Dark-coloured metal baking tins are most suitable for baking cakes, bread and other baked goods.

- Use wide, shallow cookware for bakes and gratins. Food takes longer to cook in deep, narrow cookware and it browns more on top.
- If you are cooking bakes directly in the universal pan, place the universal pan into the cooking compartment at level 2.
- The setting values for bread dough apply to both dough placed on a baking tray and dough placed in a loaf tin.

#### ATTENTION!

When the cooking compartment is hot, any water inside it will create steam. The change in temperature may cause damage.

- ▶ Never pour water into the cooking compartment when it is still hot.
- ▶ Never place cookware containing water on the cooking compartment floor.

#### Shelf positions

Baking on one level	Height
Tall baked items and tins/dishes on the wire rack	2
Shallow baked items/baking tray	3

<sup>1</sup> Only applies to Great Britain

Baking on two or more levels	Height
2 levels	
■ Universal pan	3
■ Baking tray	1
2 levels	
■ Baking tins/dishes on 2 wire racks	3 1
3 levels	
■ Baking tray	4
■ Universal pan	3
■ Baking tray	1

Use the CircoTherm hot air heating function.

**Note:** Items that are placed in the appliance on baking trays or in baking tins/dishes at the same time will not necessarily be ready at the same time.

### 26.3 Roasting, braising and grilling tips

- The recommended settings are for fridge-temperature food and unstuffed, oven-ready poultry.
- Place the poultry onto the cookware breast-side or skin-side down.
- Turn roasting joints, grilled items or whole fish after approx. 1/2 to 2/3 of the specified time.

#### Roasting on the wire rack

Food roasted on the wire rack will become very crispy on all sides. You can roast large poultry, for example, or multiple individual pieces at the same time.

- Roast pieces of a similar weight and thickness. The grilled food will brown evenly and will remain succulent and juicy.
- Place the food to be roasted directly on the wire rack.
- To catch any liquids that drip down, place the universal pan, with the wire rack inside it, into the cooking compartment at the specified shelf height.
- Add up to 1/2 litre of water to the universal pan, depending on the size and type of food that you want to roast.

You can make a sauce from the juices that are collected. This also means that less smoke is produced and the cooking compartment does not become as dirty.

#### Roasting in cookware

If you cover the cookware when you cook your food, this will keep the cooking compartment cleaner.

#### General information about roasting in cookware

- Use heat-resistant, ovenproof cookware.
- Place the cookware on the wire rack.
- Glass cookware is best.
- Follow the manufacturer's instructions for your roasting dishes.

#### Roasting in uncovered cookware

- Use a deep roasting dish.
- If you do not have any suitable cookware, you can use the universal pan.

#### Roasting in covered cookware

- Use a suitable lid that seals well.
- When roasting meat, there should be at least 3 cm between the food and the lid. The meat may expand.

#### **WARNING – Risk of scalding!**

Very hot steam may escape when the lid is opened after cooking. Steam may not be visible, depending on the temperature.

- ▶ Lift the lid in such a way that the hot steam can escape away from you.
- ▶ Keep children away from the appliance.

#### Grilling

Grill food if you want it to be crispy.

#### **ATTENTION!**

Acidic food may damage the grid

- ▶ Do not place acidic food, such as fruit or food with an acidic marinade directly on the pan support.

The "Grill" type of heating is good for cooking thinner pieces of poultry, meat and fish such as steaks, drumsticks and burgers. It is also excellent for toasting bread.

Circo-roasting is very well suited to cooking whole poultry and fish, as well as meat, e.g. roast pork with crackling.

#### Information for those allergic to nickel

In rare cases, small amounts of nickel may pass into the food.

- When grilling several food items, choose pieces that are of a similar weight and thickness. The grilled food will brown evenly and will remain succulent and juicy.
- Place the food to be grilled directly onto the wire rack.
- To catch any liquids that drip down, place the universal pan into the cooking compartment at least one level below the wire rack.

#### Notes

- The grill element switches on and off continuously. This is normal. The temperature that you set determines how frequently this occurs.
- Smoke may be produced when grilling.

### 26.4 Cooking instructions for ready meals

- The cooking result greatly depends on the quality of the food. Pre-browning and irregularities may already be present in the food before cooking.
- Do not use frozen products that are covered with a thick layer of ice. Remove any ice on the food.
- Take ready meals out of the packaging.
- If you are warming or cooking the ready meal in cookware, make sure that the cookware is heat-resistant.
- Distribute foods that are in the form of separate pieces, such as bread rolls and potato products, so that they are spread out flat and evenly on the accessory. Leave a little space between the individual pieces.
- Follow the manufacturer's instructions on the packaging.

## 26.5 List of foods

Recommended settings for a variety of foods, sorted into food categories.

### Recommended settings for various types of food

Food	Accessory/cookware	Shelf position	Heating function	Temperature in °C	Cooking time in mins
Sponge cake, delicate	Ring-shaped tin or Loaf tin	2	≡	150-170	60-80
Sponge cake, 2 levels	Ring-shaped tin or Loaf tin	3+1	⌘	140-150	70-85
Fruit tart or cheesecake with shortcrust pastry base	Springform cake tin, diameter 26 cm	2	≡	170-190	55-80
Sponge flan, 6 eggs	Springform cake tin Ø 28 cm	2	≡	150-160 <sup>1</sup>	30-40
Shortcrust tart with moist topping	Universal pan	3	≡	160-180	55-95
Yeast cake with moist topping	Universal pan	3	≡	180-190	30-55
Swiss roll	Baking tray	3	⌘	180-190 <sup>1</sup>	10-15
Muffins	Muffin tray	2	≡	170-190	20-40
Small yeast cakes	Baking tray	3	⌘	150-170	20-30
Biscuits	Baking tray	3	≡	140-160	15-25
Biscuits, 2 levels	Universal pan + Baking tray	3+1	⌘	140-160	15-30
Biscuits, 3 levels	x 2 Baking tray + Universal pan	4+3+1	⌘	140-160	15-30
Bread, 750 g	Universal pan or Loaf tin	2	⌘	<b>1.</b> 210-220 <b>2.</b> 180-190 <sup>1</sup>	<b>1.</b> 10-15 <b>2.</b> 25-35
Bread, 1500 g	Universal pan or Loaf tin	2	⌘	<b>1.</b> 210-220 <b>2.</b> 180-190 <sup>1</sup>	<b>1.</b> 10-15 <b>2.</b> 40-50
Flatbread	Universal pan	3	⌘	240-250	20-25
Bread rolls, fresh	Baking tray	3	≡	180-190	20-30
Pizza, fresh, on a baking tray	Baking tray	3	⌘	190-210	20-30
Pizza, fresh, on a baking tray, 2 levels	Universal pan + Baking tray	3+1	⌘	180-190	30-40
Pizza, fresh, thin-crust, on a pizza tray	Pizza tray	2	⌘	250-270 <sup>1</sup>	8-13
Quiche	Dark coated quiche tin	2	⌘	190-210	25-35
Tarte flambée	Universal pan	3	≡	260-270 <sup>1</sup>	10-15
Bake, savoury, cooked ingredients	Ovenproof dish	2	≡	200-220	30-60

<sup>1</sup> Preheat the appliance.

<sup>2</sup> Turn the dish between halfway and two-thirds through the cooking time.











<sup>3</sup> At the start, add liquid to the cookware so that at least 2/3 of the joint is covered in liquid

<sup>4</sup> Turn the dish 2/3 of the way through the cooking time.

<sup>5</sup> Pour water into the dish so that it covers the base.

<sup>6</sup> Do not turn the food.

<sup>7</sup> Slide the universal pan underneath the wire rack.

Food	Accessory/cookware	Shelf position	Heating function	Temperature in °C	Cooking time in mins
Potato gratin, raw ingredients, 4 cm deep	Ovenproof dish	2		150-170	60-80
Chicken, 1.3 kg, unstuffed	Uncovered cookware	2		200-220	60-70
Small chicken portions, 250 g each	Uncovered cookware	3		220-230	30-35
Goose, unstuffed, 3 kg	Uncovered cookware	2		<b>1.</b> 140 <b>2.</b> 160	<b>1.</b> 130-140 <b>2.</b> 50-60
Joint of pork without rind, e.g. neck, 1.5 kg	Uncovered cookware	2		160-170	150-160
Fillet of beef, medium, 1 kg	Wire rack + Universal pan	3		210-220	40-50 <sup>2</sup>
Pot-roasted beef, 1.5 kg <sup>3</sup>	Covered cookware	2		200-220	130-150
Sirloin, medium, 1.5 kg	Wire rack + Universal pan	3		200-220	60-70 <sup>2</sup>
Burger, 3–4 cm thick	Wire rack	4		290	25-30 <sup>4</sup>
Leg of lamb, boned, medium, 1.5 kg <sup>5</sup>	Uncovered cookware	2		170-190	70-80 <sup>6</sup>
Fish, grilled, whole, 300 g, e.g. trout <sup>7</sup>	Wire rack	2		160-180	20-30

<sup>1</sup> Preheat the appliance.

<sup>2</sup> Turn the dish between halfway and two-thirds through the cooking time.

<sup>3</sup> At the start, add liquid to the cookware so that at least 2/3 of the joint is covered in liquid

<sup>4</sup> Turn the dish 2/3 of the way through the cooking time.

<sup>5</sup> Pour water into the dish so that it covers the base.

<sup>6</sup> Do not turn the food.

<sup>7</sup> Slide the universal pan underneath the wire rack.

## Yoghurt

Use your appliance to make yoghurt.

### Making yoghurt

1. Remove the accessories and shelves from the cooking compartment.
2. Heat 1 litre of whole milk (3.5% fat) to 90 °C on the hob and then leave it to cool down to 40 °C. It is sufficient to heat UHT milk to 40 °C.

3. Mix 150 g of chilled yoghurt into the milk.
4. Pour the mixture into small containers, e.g. cups or small jars.
5. Cover the containers with film, e.g. cling film.
6. Place the containers on the cooking compartment floor.
7. Use the recommended settings when configuring the appliance settings.
8. After making the yoghurt, leave it to cool in the refrigerator for at least 12 hours.

### Recommended settings for desserts and compote

Food	Accessory/cookware	Shelf position	Heating function	Temperature in °C	Cooking time in mins
Yoghurt	Individual moulds	Cooking compartment floor		40-45	8–9 hrs

## 26.6 Special cooking methods and other applications

Information and recommended settings for special cooking methods and other applications, e.g. slow cooking.

### Slow cooking

Cook prime cuts of meat slowly at a low temperature, e.g. tender cuts of beef, veal, lamb or poultry.

### Slow cooking poultry or meat

**Note:** When using the slow cooking type of heating, you cannot delay the start of the programme by setting an end time.

**Requirement:** The cooking compartment is cold.

1. Use fresh, clean, hygienic meat without bones.
2. Place the cookware onto the wire rack at level 2 in the cooking compartment.
3. Preheat the cooking compartment and cookware for approx. 15 minutes.





4. Sear the meat on all sides on the hob at a very high heat.
5. Immediately place the meat into the pre-warmed cookware in the cooking compartment. To ensure that the temperature in the cooking compartment remains constant, keep the cooking compartment door closed during slow cooking.

### Tips for slow cooking

Here you will find tips for achieving good results when slow cooking food.

Issue	Tip
You want to slow cook a duck breast.	<ul style="list-style-type: none"> <li>■ Place the cold duck breast into a pan.</li> <li>■ Sear the skin side first.</li> <li>■ Slow cook the duck breast.</li> <li>■ After slow cooking, grill the duck breast for 3 to 5 minutes until crispy.</li> </ul>
You want to serve your slow-cooked meat as hot as possible.	<ul style="list-style-type: none"> <li>■ Preheat the serving plate.</li> <li>■ Make sure that the sauces that accompany the duck breast are very hot when you serve them.</li> </ul>

### Recommended settings for slow cooking

Food	Accessory/cookware	Shelf position	Searing time in mins	Heating function	Temperature in °C	Cooking time in mins
Duck breast, medium rare, 300 g each	Uncovered cookware	2	6-8		95 <sup>1</sup>	60-70
Fillet of pork, whole	Uncovered cookware	2	4-6		85 <sup>1</sup>	75-100
Fillet of beef, 1 kg	Uncovered cookware	2	6-8		85 <sup>1</sup>	90-150
Veal medallions, 4 cm thick	Uncovered cookware	2	4		80 <sup>1</sup>	50-70
Saddle of lamb, boned, 200 g each	Uncovered cookware	2	4		85 <sup>1</sup>	30-70

<sup>1</sup> Preheat the appliance.





## 26.7 Meals and tips for cooking for Great Britain

Recommended settings for meals with British cooking habits.

Also follow the instructions in the individual sections. This section contains only special additional information relating to British meals and cooking habits.

### Baking

#### Recommended settings for baking on one level

Food	Accessory/cookware	Shelf position	Heating function	Temperature in °C	Cooking time in mins
Victoria sponge cake	x 2 20 cm diameter cake tin	2		150-170 <sup>1</sup>	15-25
Rich fruit cake	Deep, 23 cm diameter tin	2		140-150	180-210
Fruit pie	20 cm diameter plate or Pie tin	2		160-170	55-70
Bread or white bread	Loaf tin, 1 x 900 g or 2 x 450 g	2		200-210 <sup>1</sup>	25-40

<sup>1</sup> Preheat the appliance.

<sup>2</sup> Preheat the appliance for five minutes. Do not use the rapid heating function.

<sup>3</sup> Preheat the appliance for 20 minutes.



Food	Accessory/cookware	Shelf position	Heating function	Temperature in °C	Cooking time in mins
Scones	Baking sheet on wire rack	3	≡	200-210 <sup>1</sup>	8-12
Biscuits	Baking sheet on wire rack	3	⌘	140-160 <sup>1</sup>	10-25
Small cakes	12-cup-tin	3	≡	150 <sup>2</sup>	25-35
Pavlova	Baking sheet on wire rack	3	⌘	100-110	150-180
Yorkshire pudding	12-cup-tin	3	⌘	200-220 <sup>3</sup>	15-25

<sup>1</sup> Preheat the appliance.

<sup>2</sup> Preheat the appliance for five minutes. Do not use the rapid heating function.

<sup>3</sup> Preheat the appliance for 20 minutes.

### Recommended settings for baking on several levels

Food	Accessory/cookware	Shelf position	Heating function	Temperature in °C	Cooking time in mins
Victoria sponge cake, 2 levels	x 4 20 cm diameter cake tin	3+1	⌘	150-160 <sup>1</sup>	20-30
Biscuits, 2 levels	x 2 Baking sheet on wire rack	3+1	⌘	140-160 <sup>1</sup>	15-30
Biscuits, 3 levels	x 3 Baking sheet on wire rack	4+3+1	⌘	140-160 <sup>1</sup>	15-30

<sup>1</sup> Preheat the appliance.

## Grilling

### Recommended settings for meat

Food	Accessory/cookware	Shelf position	Heating function	Temperature in °C	Cooking time in mins
Pork, Bacon rashers <sup>1</sup>	Wire rack	3	⋈	290 <sup>2</sup>	<b>1.</b> 4-5 <b>2.</b> 3-4 <sup>3</sup>
Pork, Sausages, thickness 2-4 cm	Wire rack	3	⋈	275 <sup>4</sup>	10-20 <sup>5</sup>
Pork, Gammon joint	Uncovered cookware	2	⌘	170-180	25+20 <sup>6</sup>

<sup>1</sup> Slide the universal pan underneath the wire rack.

<sup>2</sup> Preheat the appliance for 5 minutes.

<sup>3</sup> Turn the food occasionally.

<sup>4</sup> Preheat the appliance for three minutes.

<sup>5</sup> Turn the food several times.

<sup>6</sup> Do not turn the food.

### Recommended settings for poultry

Food	Accessory/cookware	Shelf position	Heating function	Temperature in °C	Cooking time in mins
Chicken, whole <sup>1</sup>	Wire rack	2	⌘	170-180	25+20

<sup>1</sup> Slide the universal pan underneath the wire rack.

## Roasting and braising

### Cooking tips for roasting and braising

Follow this information when frying or braising poultry or meat.

Calculating the cooking time, e.g. 20+35:





- To calculate the cooking time, assume 20 minutes per 500 g of meat. Then add an extra 35 minutes to that figure.

- For 1.5 kg, the cooking time would therefore be 95 minutes.



Cooking time range, e.g. 10-15:

- Your food will be ready within the specified range of time (in minutes).

### Recommended settings for meat

Food	Accessory/cookware	Shelf position	Heating function	Temperature in °C	Cooking time in mins
Beef, Top side, Top rump	Uncovered cookware	2		170	40+30
Lamb, Leg, bone-in	Uncovered cookware	2		160-170	25+15
Pork, Belly	Uncovered cookware	2	1.  2. 	1. 170-180 2. 251	1. 30+30 2. 3-5

### Recommended settings for poultry

Food	Accessory/cookware	Shelf position	Heating function	Temperature in °C	Cooking time in mins
Chicken, whole <sup>1</sup>	Wire rack	2		170-180	25+15
Turkey, crown	Wire rack	2		140-150	20+25
Turkey, whole, 4-8 kg	Wire rack	2		150-160	12+12 <sup>2</sup>

<sup>1</sup> Slide the universal pan underneath the wire rack.

<sup>2</sup> Turn the food after approx. one hour.

### Recommended settings for bakes

Food	Accessory/cookware	Shelf position	Heating function	Temperature in °C	Cooking time in mins
Diced meat, e.g. beef, pork, lamb, 500 g meat	Covered cookware	2		140	120-140

### Recommended settings for complete meals

Food	Accessory/cookware	Shelf position	Heating function	Temperature in °C	Cooking time in mins
Complete meal with Chicken <sup>1</sup>	x 2 Wire rack + Universal pan	4+1		1. 180 2. Then 200 (Yorkshire pudding)	Chicken: (25+25) + 20

<sup>1</sup> Slide the universal pan underneath the wire rack.

## 26.8 Test dishes

The information in this section is provided for test institutes to facilitate testing of the appliance in accordance with EN 60350-1.

### Baking

- The setting values apply to food that is placed into a cold cooking compartment.
- Take note of the information on preheating in the recommended settings tables. These setting values apply without rapid heat-up.
- For baking, use the lower of the temperatures indicated first.
- Items that are placed in the appliance on baking trays or in baking tins/dishes at the same time will not necessarily be ready at the same time.
- Shelf positions when baking on 2 levels:
  - Universal pan: Shelf position 3
  - Baking tray: Shelf position 1
  - Baking tins on the wire rack: First wire rack: Shelf position 3 Second wire rack: Shelf position 1
- Shelf positions when baking on 3 levels:
  - Baking tray: Shelf position 4
  - Universal pan: Shelf position 3
  - Baking tray: Shelf position 1
- Hot water sponge cake
  - When baking on 2 levels, place the springform tins each in the centre of the wire racks.
  - As an alternative to a pan support, you can also use the Air Fry baking tray offered by us.

### Recommended settings for baking

Food	Accessory/cookware	Shelf position	Heating function	Temperature in °C	Cooking time in mins
Shortbread	Baking tray	3	≡	140-150 <sup>1</sup>	25-35
Shortbread	Baking tray	3	⌚	140-150 <sup>1</sup>	20-30
Shortbread, 2 levels	Universal pan + Baking tray	3+1	⌚	140-150 <sup>1</sup>	25-35
Shortbread, 3 levels	x 2 Baking tray + Universal pan	4+3+1	⌚	130-140 <sup>1</sup>	35-55
Small cakes	Baking tray	3	≡	150 <sup>1</sup>	25-35
Small cakes	Baking tray	3	⌚	150 <sup>1</sup>	20-30
Small cakes, 2 levels	Universal pan + Baking tray	3+1	⌚	140 <sup>1</sup>	25-35
Small cakes, 3 levels	x 2 Baking tray + Universal pan	4+3+1	⌚	140 <sup>1</sup>	25-35
Hot water sponge cake	Springform cake tin, diameter 26 cm	2	≡	160-170 <sup>2</sup>	25-35
Hot water sponge cake	Springform cake tin, diameter 26 cm	2	⌚	160-170	30-35
Hot water sponge cake, 2 levels	x 2 Springform cake tin, diameter 26 cm	3+1	⌚	150-160 <sup>2</sup>	35-50

<sup>1</sup> Preheat the appliance for five minutes. Do not use the rapid heating function.

<sup>2</sup> Preheat the appliance. Do not use the rapid heating function.

### Grilling

#### Recommended settings for grilling

Food	Accessory/cookware	Shelf position	Heating function	Temperature in °C	Cooking time in mins
Toasting bread	Wire rack	4	⚡	290 <sup>1</sup>	5-6

<sup>1</sup> Do not preheat the appliance.

## 27 Installation instructions

Observe this information when installing the appliance.



### 27.1 General installation instructions

Follow these instructions before you start with the installation of the appliance.

- The safe operation of this appliance can only be guaranteed if it has been installed to a professional standard in accordance

with these installation instructions. The installer shall be liable for damages incurred as a result of incorrect installation.

- Do not use the door handle for the transport or installation.
- Check the appliance for damage after unpacking it. Do not connect the appliance if it has been damaged in transit.
- Before starting up the appliance, remove any packaging material and adhesive film from the cooking compartment and the door.

- Proceed in accordance with the installation sheets for installing accessories.
- Fitted units must be heat-resistant up to 95 °C, and adjacent unit fronts up to 70 °C.
- Do not install the appliance behind a decorative door or the door of a kitchen unit. There is a risk of overheating.
- Cut-out work on the units should be carried out before installing the appliance. Remove any shavings. Otherwise, the correct operation of electrical components may be adversely affected.
- The mains socket for the appliance must either be located in the hatched area **a** or outside of the area where the appliance is installed.  
Any unsecured units must be secured to the wall using a standard bracket **b**.

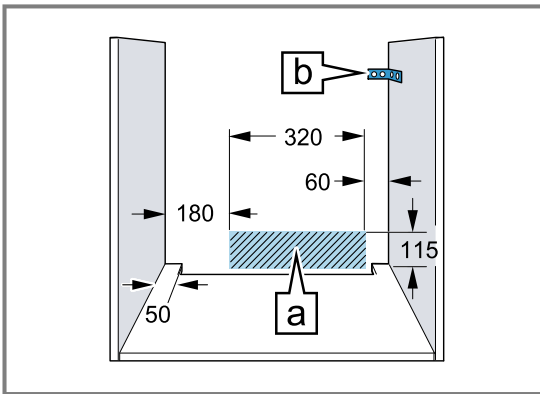

- Wear protective gloves so that you do not cut yourself. Parts that are accessible during installation may have sharp edges.
- Dimensions of the figures in mm.

### **⚠ WARNING – Risk of fire!**

It is dangerous to use an extended power cord and non-approved adapters.

- ▶ Do not use multiple socket strips.
- ▶ Only use extension cables that are certified, have a minimum cross section of 1.5 mm<sup>2</sup> and comply with the applicable national safety requirements.
- ▶ If the power cord is too short, contact customer service.

- ▶ Only use adapters approved by the manufacturer.

### **ATTENTION!**

Carrying the appliance by the door handle could break it. The door handle cannot support the weight of the appliance.

- ▶ Do not carry or hold the appliance by the door handle.

## **27.2 Appliance dimensions**

You will find the dimensions of the appliance here

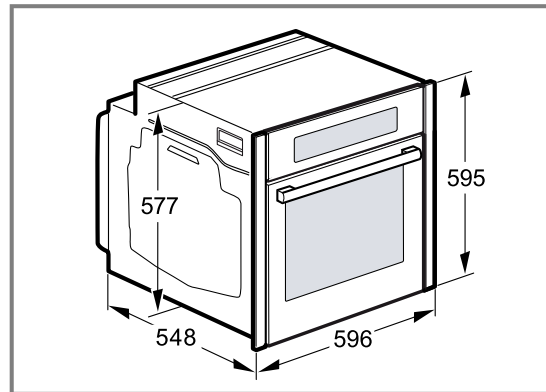

## **27.3 Installation below a worktop**

Observe the installation dimensions and the installation instructions when installing below a worktop.

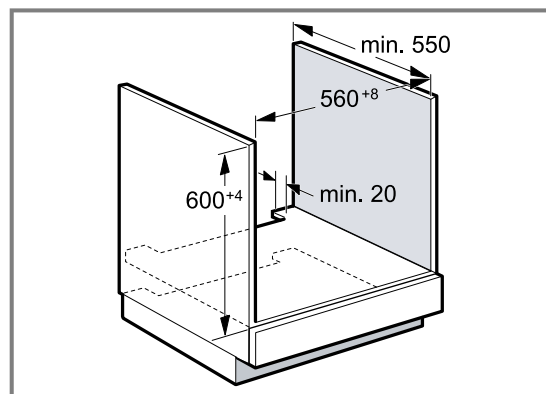

- To ventilate the appliance, the intermediate floor must have a ventilation cut-out.
- The worktop must be secured to the fitted unit.
- Observe any available installation instructions for the hob.
- Observe different national installation instructions for the hob.

## 27.4 Installation underneath a hob

If the appliance is installed under a hob, the following minimum dimensions must be adhered to (including substructure, if applicable).

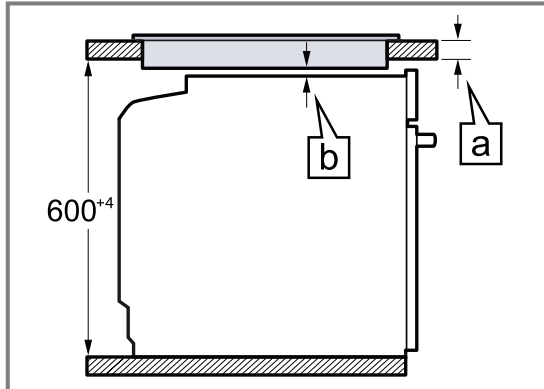

The minimum worktop thickness  $\boxed{a}$  is based on the required minimum clearance  $\boxed{a}$ .

Hob type	a raised in mm	a flush in mm	b in mm
Induction hob	37	38	5
Full-surface induction hob	47	48	5
Gas hob	27	38	5 <sup>1</sup>
Electric hob	27	30	2

<sup>1</sup> Observe different national installation instructions for the hob.

## 27.5 Installation in a tall unit

Observe the installation dimensions and the installation instructions when installing in a tall unit.

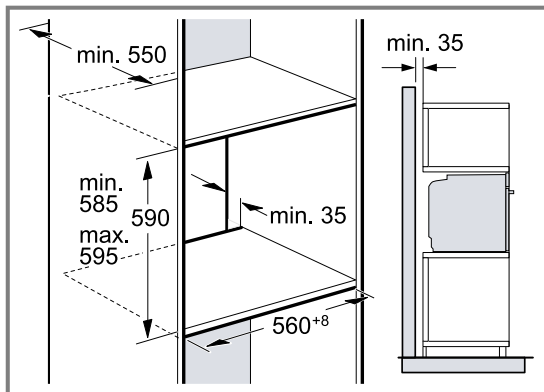

- To ventilate the appliance, the intermediate floors must have a ventilation cut-out.
- If the tall unit has another back panel in addition to the element back panels, this must be removed.
- Only fit the appliance up to a height which allows accessories to be easily removed.

## 27.6 Installing two appliances on top of each other

Your appliance can also be installed above or below another appliance. Observe the installation dimensions and the installation instructions when installing appliances on top of each other.

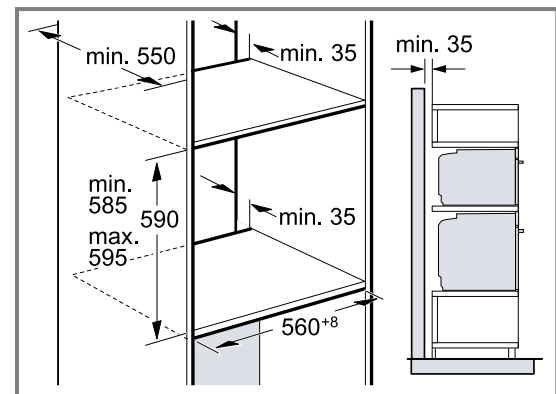

- To ventilate the appliances, the intermediate floor must have a ventilation cut-out.
- To ensure sufficient ventilation of the two appliances, there must be a ventilation opening of at least 200 cm<sup>2</sup> in the base area. To do this, trim the base panel or fit a ventilation grille.



- Ensure that air exchange is guaranteed in accordance with the diagram.

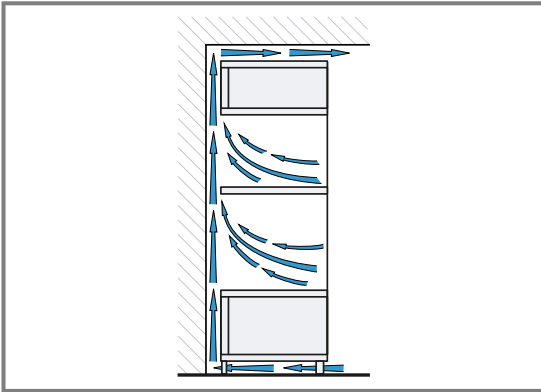

- Only fit appliances up to a height that allows accessories to be easily removed.

### 27.7 Corner installation

Observe the installation dimensions and the installation instructions when installing in a corner.

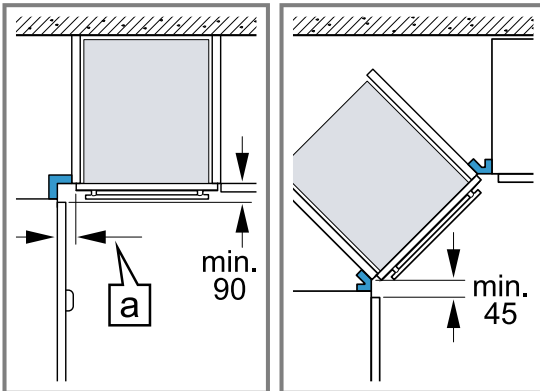

- To ensure that the appliance door can be opened, you must take the minimum dimensions into consideration when installing in a corner. The dimension  $a$  is dependent on the thickness of the unit front and the handle.

### 27.8 Electrical connection

In order to safely connect the appliance to the electrical system, follow these instructions.

- The appliance corresponds to protection class I and must only be operated with a protective earth connection.
- The fuse protection must correspond to the power rating specified on the appliance's rating plate and to the local regulations.
- The appliance must be disconnected from the power supply whenever installation work is being carried out.
- The appliance must only be connected using the power cable provided.
- The power cable must be plugged in at the rear of the appliance until you hear a clicking sound. A 3 m power cable can be obtained from the after-sales service.
- The power cable must only be replaced with a cable from the original manufacturer. This is available from after-sales service.

- Contact protection must be guaranteed by the installation.
- If the display on the appliance remains dark, it has not been connected correctly. Disconnect the appliance from the mains and check the connection.

### Electrically connect the appliance with the protective contact plug

**Note:** The appliance must only be connected to a protective contact socket that has been correctly installed.

- Insert the plug into the protective contact socket. When the appliance is installed, the mains plug of the power cord must be freely accessible. If free access is not possible, an isolating switch must be integrated into the permanent electrical installation according to the installation regulations.

### Electrically connecting an appliance without a protective contact plug

**Note:** Only licensed specialists may connect the appliance. Damage caused by incorrect connection is not covered under the warranty.

An isolating switch must be integrated into the permanent electrical installation according to the installation regulations.

- Identify the phase and neutral conductors in the socket. The appliance may be damaged if it is not connected correctly.
- Connect the hob in accordance with the connection diagram. See the rating plate for the voltage.
- Connect the wires of the mains power cable according to the colour coding:
  - Green/yellow = Protective conductor  $\oplus$
  - Blue = Neutral conductor
  - Brown = Phase (external conductor)

### 27.9 Installing the appliance

**Note:** Do not use a cordless screwdriver to secure the panels. This may damage the panels.

- Push the appliance in fully. Do not kink or trap the connection cable, or route it over sharp edges.
- Centre the appliance.

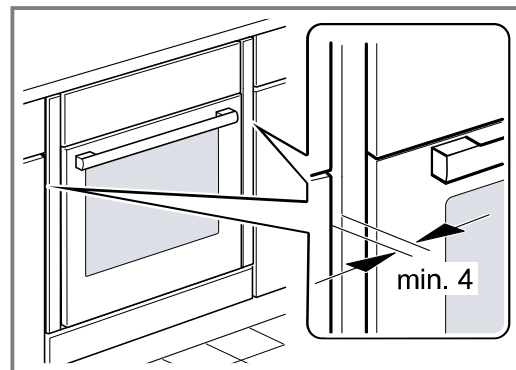

There must be an air gap of at least 4 mm between the appliance and adjacent unit fronts.

3. Open the appliance door and unscrew the left and right-hand panels.

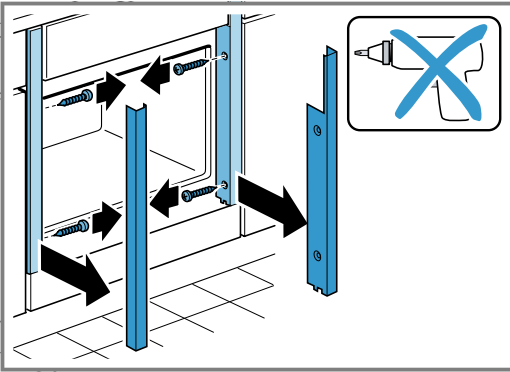

4. Close the appliance door.  
5. Screw the appliance into place.

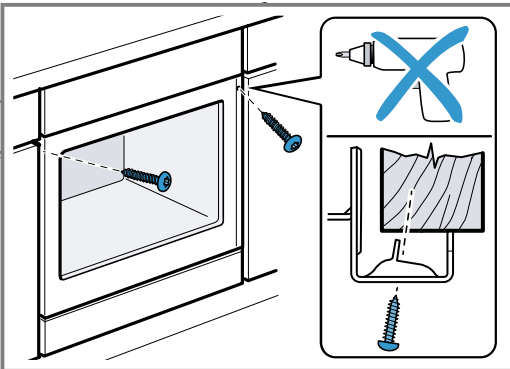

6. For handleless kitchens with vertical bar handle strips:
- Attach a suitable filling piece ① in order to cover any sharp edges and to guarantee a safe installation.
  - Pre-drill aluminium profiles to establish a screw connection ②.
  - Secure the appliance using a suitable screw ③.

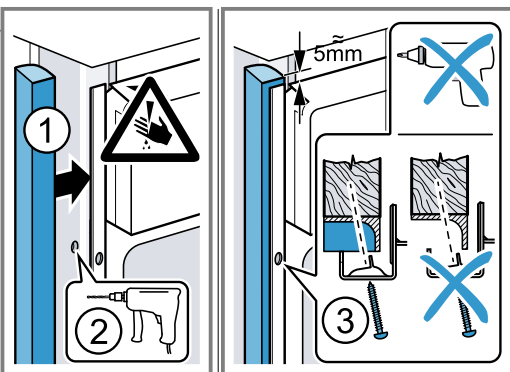

7. Refit the panels and screw them in place, first at the top and then at the bottom.

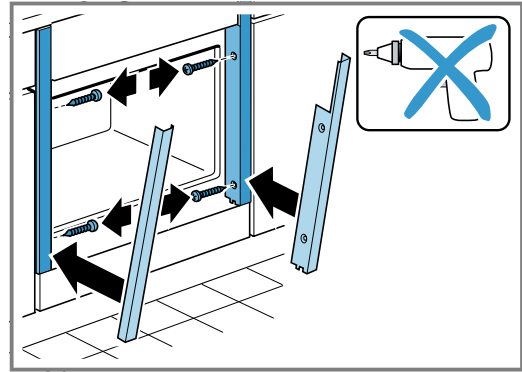

8. If required, the gap between the appliance door and the side panels can be adjusted using the screws at the top left and right.

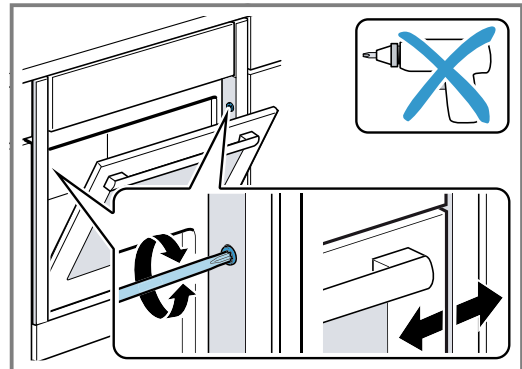

**Note:** The gap between the worktop and the appliance must not be closed by additional battens. Thermal insulation strips must not be fitted to the side panels of the surround unit.

## 27.10 Removing the appliance

1. Disconnect the appliance from the power supply.
2. Open the appliance door and unscrew the left and right-hand panels.
3. Undo the fastening screws.
4. Lift the appliance slightly and pull it out completely.





Valid within Great Britain:  
Imported to Great Britain by  
BSH Home Appliances Ltd.  
Grand Union House  
Old Wolverton Road  
Wolverton, Milton Keynes  
MK12 5PT  
United Kingdom



Register your product online  
**neff-home.com**

**BSH Hausgeräte GmbH**  
Carl-Wery-Straße 34  
81739 München, GERMANY



**9001696284**  
030131  
en

