

**BDL3260EL**  
**V1.00**



[www.philips.com/welcome](http://www.philips.com/welcome)  
User Manual (English)

**PHILIPS**  
**Signage**Solutions

# Safety Instructions

## Safety precautions and maintenance



**WARNING:** Use of controls, adjustments or procedures other than those specified in this documentation may result in exposure to shock, electrical hazards and/or mechanical hazards.

### Read and follow these instructions when connecting and using your display:

#### Operation:

- Keep the display out of direct sunlight and away from stoves or any other heat sources.
- Remove any object that could fall into ventilation holes or prevent proper cooling of the display's electronics.
- Do not block the ventilation holes on the cabinet.
- When positioning the display, make sure the power plug and outlet are easily accessible.
- When turning off the display by detaching the power cord, wait 6 seconds before re-attaching the power cord for normal operation.
- Ensure the use of an approved power cord provided by Philips at all times. If your power cord is missing, please contact your local service center.
- Do not subject the display to severe vibration or high impact conditions during operation.
- Do not knock or drop the display during operation or transportation.

#### Maintenance:

- To protect your display from possible damage, do not put excessive pressure on the LCD panel. When moving your display, grasp the frame to lift; do not lift the display by placing your hand or fingers on the LCD panel.
- Unplug the display if you are not going to use it for an extensive period of time.
- Unplug the display if you need to clean it with a slightly damp cloth. The screen may be wiped with a dry cloth when the power is off. However, never use organic solvent, such as, alcohol, or ammonia-based liquids to clean your display.
- To avoid the risk of shock or permanent damage to the set, do not expose the display to dust, rain, water or an excessively moist environment.
- If your display becomes wet, wipe it with dry cloth as soon as possible.
- If a foreign substance or water gets in your display, turn the power off immediately and disconnect the power cord. Then remove the foreign substance or water, and send the unit to the maintenance center.
- Do not store or use the display in locations exposed to heat, direct sunlight or extreme cold.
- In order to maintain the best performance of your display and ensure a longer lifetime, we strongly recommend using the display in a location that falls within the following temperature and humidity ranges.
  - Temperature: 0-40°C 32-104°F
  - Humidity: 20-80% RH

**IMPORTANT:** Always activate a moving screen saver program when you leave your display unattended. Always activate a periodic screen refresh application if the unit will display unchanging static content. Uninterrupted display of still or static images over an extended period may cause "burn in", also known as "after-imaging" or "ghost imaging", on your screen. This is a well-known phenomenon in LCD panel technology. In most cases, the "burned in" or "after-imaging" or "ghost imaging" will disappear gradually over a period of time after the power has been switched off.

**WARNING:** Severe "burn-in" or "after-image" or "ghost image" symptoms will not disappear and cannot be repaired. This is also not covered under the terms of your warranty.

#### Service:

- The casing cover should be opened only by qualified service personnel.
- If there is any need for repair or integration, please contact your local service center.
- Do not leave your display under direct sunlight.



If your display does not operate normally, having followed the instructions set out in this document, please contact a technician or your local service center.

**Read and follow these instructions when connecting and using your display:**

- Unplug the display if you are not going to use it for an extensive period of time.
- Unplug the display if you need to clean it with a slightly damp cloth. The screen may be wiped with a dry cloth when the power is off. However, never use alcohol, solvents or ammonia-based liquids.
- Consult a service technician if the display does not operate normally when you have followed the instructions in this manual.
- The casing cover should be opened only by qualified service personnel.
- Keep the display out of direct sunlight and away from stoves or any other heat sources.
- Remove any object that could fall into the vents or prevent proper cooling of the display's electronics.
- Do not block the ventilation holes on the cabinet.
- Keep the display dry. To avoid electric shock, do not expose it to rain or excessive moisture.
- When turning off the display by detaching the power cable or DC power cord, wait for 6 seconds before re-attaching the power cable or DC power cord for normal operation.
- To avoid the risk of shock or permanent damage to the set do not expose the display to rain or excessive moisture.
- When positioning the display, make sure the power plug and outlet are easily accessible.
- **IMPORTANT:** Always activate a screen saver program during your application. If a still image in high contrast remains on the screen for an extended period of time, it may leave an 'after-image' or 'ghost image' on the front of the screen. This is a well-known phenomenon that is caused by the shortcomings inherent in LCD technology. In most cases the afterimage will disappear gradually over a period of time after the power has been switched off. Be aware that the after-image symptom cannot be repaired and is not covered under warranty.

**CE Declaration of Conformity**

We declare under our responsibility that the product is in conformity with the following standards:

- EN60950-1:2006+A11:2009+A1:2010+A12:2011+A2:2013 (Safety requirement of Information Technology Equipment).
- EN55022:2010 (Radio Disturbance requirement of Information Technology Equipment).
- EN55024:2010 (Immunity requirement of Information Technology Equipment).
- EN61000-3-2:2006 +A1:2009+A2:2009 (Limits for Harmonic Current Emission).
- EN61000-3-3:2008 (Limitation of Voltage Fluctuation and Flicker)
- EN 50581:2012 (Technical documentation for the assessment of electrical and electronic products with respect to the restriction of hazardous substances)
- EN 50564:2011 (Electrical and electronic household and office equipment — Measurement of low power consumption)

following provisions of directives applicable.

- 2006/95/EC (Low Voltage Directive).
- 2004/108/EC (EMC Directive).
- 2009/125/EC (ErP, Energy-related Product Directive, EC No. 1275/2008 and 642/2009 Implementing)
- 2011/65/EU (RoHS Directive) and is produced by a manufacturing organization on ISO9000 level.

**Federal Communications Commission (FCC) Notice (U.S. Only)**

This equipment has been tested and found to comply with the limits for a Class B digital device, pursuant to part 15 of the FCC Rules. These limits are designed to provide reasonable protection against harmful interference in a residential installation. This equipment generates, uses and can radiate radio frequency energy and, if not installed and used in accordance with the instructions, may cause harmful interference to radio communications. However, there is no guarantee that interference will not occur in a particular installation. If this equipment does cause harmful interference to radio or television reception, which can be determined by turning the equipment off and on, the user is encouraged to try to correct the interference by one or more of the following measures:

- Reorient or relocate the receiving antenna.
- Increase the separation between the equipment and receiver.
- Connect the equipment into an outlet on a circuit different from that to which the receiver is connected.
- Consult the dealer or an experienced radio/TV technician for help.



Changes or modifications not expressly approved by the party responsible for compliance could void the user's authority to operate the equipment.

Use only an RF shielded cable that was supplied with the display when connecting this display to a computer device.

To prevent damage which may result in fire or shock hazard, do not expose this appliance to rain or excessive moisture.

THIS CLASS B DIGITAL APPARATUS MEETS ALL REQUIREMENTS OF THE CANADIAN INTERFERENCE- CAUSING EQUIPMENT REGULATIONS.



This device complies with Part 15 of the FCC Rules. Operation is subject to the following two conditions: (1) this device may not cause harmful interference, and (2) this device must accept any interference received, including interference that may cause undesired operation.

## Polish Center for Testing and Certification Notice

The equipment should draw power from a socket with an attached protection circuit (a three-prong socket). All equipment that works together (computer, display, printer, and so on) should have the same power supply source.

The phasing conductor of the room's electrical installation should have a reserve short-circuit protection device in the form of a fuse with a nominal value no larger than 16 amperes (A).

To completely switch off the equipment, the power supply cable must be removed from the power supply socket, which should be located near the equipment and easily accessible.

A protection mark "B" confirms that the equipment is in compliance with the protection usage requirements of standards PN-93/T-42107 and PN-89/E-06251.

### *Wymagania Polskiego Centrum Badań i Certyfikacji*

Urządzenie powinno być zasilane z gniazda z przyłączonym obwodem ochronnym (gniazdo z kolkiem). Współpracujące ze sobą urządzenia (komputer, monitor, drukarka) powinny być zasilane z tego samego źródła.

Instalacja elektryczna pomieszczenia powinna zawierać w przewodzie fazowym rezerwową ochronę przed zwarciami, w postaci bezpiecznika o wartości znamionowej nie większej niż 16A (amperów).

W celu całkowitego wyłączenia urządzenia z sieci zasilania, należy wyjąć wtyczkę kabla zasilającego z gniazdka, które powinno znajdować się w pobliżu urządzenia i być łatwo dostępne.

Znak bezpieczeństwa "B" potwierdza zgodność urządzenia z wymaganiami bezpieczeństwa użytkownika zawartymi w PN-93/T-42107 i PN-89/E-06251.

### *Pozostałe instrukcje bezpieczeństwa*

- Nie należy używać wtyczek adapterowych lub usuwać kolka obwodu ochronnego z wtyczki. Jeżeli konieczne jest użycie przedłużacza to należy użyć przedłużacza 3-żyłowego z prawidłowo połączonym przewodem ochronnym.
- System komputerowy należy zabezpieczyć przed nagłymi, chwilowymi wzrostami lub spadkami napięcia, używając eliminatora przepięć, urządzenia dopasowującego lub bezzakłóceńowego źródła zasilania.
- Należy upewnić się, aby nic nie leżało na kablach systemu komputerowego, oraz aby kable nie były umieszczone w miejscu, gdzie można byłoby na nie nadeptywać lub potykać się o nie.
- Nie należy rozlewać napojów ani innych płynów na system komputerowy.
- Nie należy wpychać żadnych przedmiotów do otworów systemu komputerowego, gdyż może to spowodować pożar lub porażenie prądem, poprzez zwarcie elementów wewnętrznych.
- System komputerowy powinien znajdować się z dala od grzejników i źródeł ciepła. Ponadto, nie należy blokować otworów wentylacyjnych. Należy unikać kładzenia luźnych papierów pod komputer oraz umieszczania komputera w ciasnym miejscu bez możliwości cyrkulacji powietrza wokół niego.



## Electric, Magnetic and Electromagnetic Fields (“EMF”)

1. We manufacture and sell many products targeted at consumers, which, like any electronic apparatus, in general have the ability to emit and receive electromagnetic signals.
2. One of our leading Business Principles is to take all necessary health and safety measures for our products, to comply with all applicable legal requirements and to stay well within the EMF standards applicable at the time of producing the products.
3. We are committed to develop, produce and market products that cause no adverse health effects.
4. We confirm that if its products are handled properly for their intended use, they are safe to use according to scientific evidence available today.
5. We play an active role in the development of international EMF and safety standards, enabling us to anticipate further developments in standardization for early integration in its products.

### Information for U.K. only

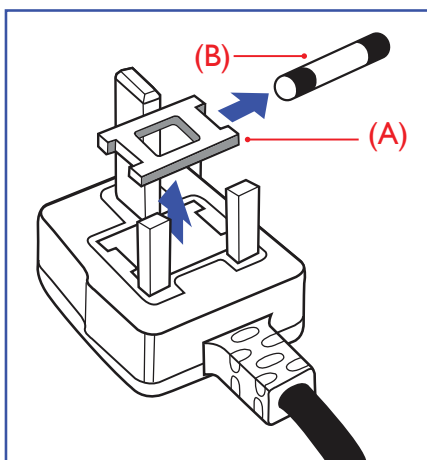

#### **WARNING - THIS APPLIANCE MUST BE EARTHED.**

##### **Important:**

This apparatus is supplied with an approved moulded 13A plug. To change a fuse in this type of plug proceed as follows:

1. Remove fuse cover and fuse.
2. Fit new fuse which should be a BS 1362 5A, A.S.T.A. or BSI approved type.
3. Refit the fuse cover.

If the fitted plug is not suitable for your socket outlets, it should be cut off and an appropriate 3-pin plug fitted in its place.

If the mains plug contains a fuse, this should have a value of 5A. If a plug without a fuse is used, the fuse at the distribution board should not be greater than 5A.

NOTE: The severed plug must be destroyed to avoid a possible shock hazard should it be inserted into a 13A socket elsewhere.

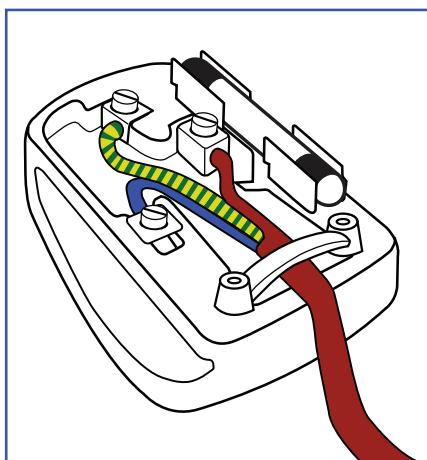

#### **How to connect a plug**

The wires in the mains lead are coloured in accordance with the following code:

- BLUE - "NEUTRAL" ("N")
- BROWN - "LIVE" ("L")
- GREEN & YELLOW - "EARTH" ("E")

1. The GREEN & YELLOW wire must be connected to the terminal in the plug which is marked with the letter "E" or by the Earth symbol or coloured GREEN or GREEN & YELLOW.
2. The BLUE wire must be connected to the terminal which is marked with the letter "N" or coloured BLACK.
3. The BROWN wire must be connected to the terminal which marked with the letter "L" or coloured RED.

Before replacing the plug cover, make certain that the cord grip is clamped over the sheath of the lead - not simply over the three wires.

## China RoHS

中国电子信息产品污染控制标识要求 (中国RoHS法规标示要求) 产品中有毒有害物质或元素的名称及含量

部件名称	有毒有害物质或元素					
	铅 (Pb)	汞 (Hg)	镉 (Cd)	六价铬 (Cr 6+)	多溴联苯 (PBB)	多溴二苯醚 (PBDE)
外壳	○	○	○	○	○	○
液晶面板	×	○	○	○	○	○
电路板组件	×	○	○	○	○	○
附件 (遥控器, 电源线, 连接线)	×	○	○	○	○	○
遥控器电池	×	○	○	○	○	○

○: 表示该有毒有害物质在该部件所有均质材料中的含量均在 GB/T26572-2011 标准规定的限量要求以下。

×: 表示该有毒有害物质至少在该部件的某一均质材料中的含量超出 GB/T26572-2011 标准规定的限量要求。



### 环保使用期限

此标识指期限(十年)，电子信息产品中含有的有毒有害物质或元素在正常使用的条件下不会发生外泄或突变，电子信息产品用户使用该电子信息产品不会对环境造成严重污染或对其人身、财产造成严重损害的期限。

## 中国能源效率标识

根据中国大陆《能源效率标识管理办法》，本显示器符合以下要求

能源效率 (cd/W)	>1.05
能效等级	1 级
能效标准	GB 21520-2008

详细有关信息请查阅中国能效标识网：<http://www.energylabel.gov.cn/>

### 《废弃电器电子产品回收处理管理条例》提示性说明

为了更好地关爱及保护地球，当用户不再需要此产品或产品寿命终止时，请遵守国家废弃电器电子产品回收处理相关法律法规，将其交给当地具有国家认可的回收处理资质的厂商进行回收处理。

## North Europe (Nordic Countries) Information

Placering/Ventilation

**VARNING:**

FÖRSÄKRA DIG OM ATT HUVUDBRYTARE OCH UTTAG ÄR LÄTÅTKOMLIGA, NÄR DU STÄLLER DIN UTRUSTNING PÅPLATS.

Placering/Ventilation

**ADVARSEL:**

SØRG VED PLACERINGEN FOR, AT NETLEDNINGENS STIK OG STIKKONTAKT ER NEMT TILGÆNGELIGE.

Paikka/Ilmankierto

**VAROITUS:**

SIJOITA LAITE SITEN, ETTÄ VERKKOJOHTO VOIDAAN TARVITTAESSA HELPOSTI IRROTTAA PISTORASIESTA.

Plassering/Ventilasjon

**ADVARSEL:**

NÅR DETTE UTSTYRET PLASSERES, MÅ DU PASSE PÅ AT KONTAKTENE FOR STØMTILFØRSEL ER LETTE Å NÅ.

## End-of-Life Disposal

Your new Public Information Display contains materials that can be recycled and reused. Specialized companies can recycle your product to increase the amount of reusable materials and to minimize the amount to be disposed of.

Please find out about the local regulations on how to dispose of your old display from your local Philips dealer.

### (For customers in Canada and U.S.A.)

This product may contain lead and/or mercury. Dispose of in accordance to local-state and federal regulations. For additional information on recycling contact [www.eia.org](http://www.eia.org) (Consumer Education Initiative)

## Waste Electrical and Electronic Equipment-WEEE

### Attention users in European Union private households



This marking on the product or on its packaging illustrates that, under European Directive 2012/19/EU governing used electrical and electronic appliances, this product may not be disposed of with normal household waste. You are responsible for disposal of this equipment through a designated waste electrical and electronic equipment collection. To determine the locations for dropping off such waste electrical and electronic, contact your local government office, the waste disposal organization that serves your household or the store at which you purchased the product.

### Attention users in United States:

Please dispose of according to all Local, State and Federal Laws. For the disposal or recycling information, contact: [www.mygreenelectronics.com](http://www.mygreenelectronics.com) or [www.eiae.org](http://www.eiae.org).

### End of Life Directives-Recycling



Your new Public Information Display contains several materials that can be recycled for new users.

Please dispose of according to all Local, State, and Federal laws.



As an ENERGY STAR Partner;

we have determined that this product meets the ENERGY STAR guidelines for energy efficiency.

### Restriction on Hazardous Substances statement (India)

This product complies with the "India E-waste Rule 2011" and prohibits use of lead, mercury, hexavalent chromium, polybrominated biphenyls or polybrominated diphenyl ethers in concentrations exceeding 0.1 weight % and 0.01 weight % for cadmium, except for the exemptions set in Schedule 2 of the Rule.

### E-Waste Declaration for India



This symbol on the product or on its packaging indicates that this product must not be disposed of with your other household waste. Instead it is your responsibility to dispose of your waste equipment by handing it over to a designated collection point for the recycling of waste electrical and electronic equipment. The separate collection and recycling of your waste equipment at the time of disposal will help to conserve natural resources and ensure that it is recycled in a manner that protects human health and the environment. For more information about where you can drop off your waste equipment for recycling in India please visit the below web link.



<http://www.india.philips.com/about/sustainability/recycling/index.page>

# Table Of Contents

<b>1. Unpacking and Installation</b> .....	<b>1</b>
1.1. Unpacking.....	1
1.2. Package Contents.....	1
1.3. Installation Notes.....	1
1.4. Installing and Removing Table Stands (optional).....	2
1.5. Mounting on a Wall.....	3
1.5.1. VESA Grid.....	3
1.6. Mounting in Portrait Position.....	4
1.6.1. How to use the logo guider for portrait position.....	4
1.6.2. How to remove the logo.....	4
1.7. Operating Instructions of Edge Alignment Kit.....	5
1.7.1. Installing Edge Alignment Kit.....	5
<b>2. Parts and Functions</b> .....	<b>6</b>
2.1. Control Panel.....	6
2.2. Input/Output Terminals.....	7
2.3. Remote Control.....	8
2.3.1. General functions.....	8
2.3.2. Inserting the batteries in the remote control.....	9
2.3.3. Handling the remote control.....	9
2.3.4. Operating range of the remote control.....	9
<b>3. Connecting External Equipment</b> .....	<b>10</b>
3.1. Connecting External Equipment (DVD/VCR/VCD).....	10
3.1.1. Using COMPONENT video input.....	10
3.1.2. Using Video Source input.....	10
3.1.3. Using HDMI video input.....	11
3.2. Connecting a PC.....	11
3.2.1. Using VGA input.....	11
3.2.2. Using DVI input.....	11
3.2.3. Using HDMI input.....	12
3.2.4. Using DisplayPort input.....	12
3.3. Connecting Audio Equipment.....	12
3.3.1. Connecting external speakers.....	12
3.3.2. Connecting an external audio device.....	13
3.4. Connecting Multiple Displays in a Daisy-chain Configuration.....	13
3.4.1. Display control connection.....	13
3.4.2. Digital video connection.....	13
3.4.3. Analog video connection.....	14
3.5. IR connection.....	14
3.6. IR Pass-through Connection.....	15
3.7. Wire-connecting to Network.....	15
<b>4. Operation</b> .....	<b>16</b>
4.1. Watch the Connected Video Source.....	16
4.2. Change Picture Format.....	16
4.3. Choose your Preferred Picture Settings.....	16
4.4. Choose your Preferred Sound Settings.....	16
4.5. Play multimedia files via Local Area Network.....	16
4.5.1. Set up the network.....	16
4.5.2. How to use DLNA-DMP.....	16
4.5.3. How to use DLNA-DMR from PC.....	17
4.6. Play multimedia files from USB device.....	18
4.7. Play options.....	18
4.7.1. Playing music files.....	18
4.7.2. Playing movie files.....	19
4.7.3. Playing photo files.....	19
4.8. How to use Opera browser (HTML5).....	19
<b>5. Change your settings</b> .....	<b>20</b>
5.1. Quick picture and sound.....	20
5.2. Settings.....	21
5.2.1. Picture.....	21
5.2.2. Sound.....	21
5.2.3. Tiling.....	22
5.2.4. General settings.....	23
5.3. Network Settings.....	25
<b>6. USB device compatibility</b> .....	<b>26</b>
<b>7. Input Mode</b> .....	<b>27</b>
<b>8. Pixel Defect Policy</b> .....	<b>28</b>
8.1. Pixels and Sub-Pixels.....	28
8.2. Types of Pixel Defects + Dot Definition.....	28
8.3. Bright Dot Defects.....	28
8.4. Dark Dot Defects.....	29
8.5. Proximity of Pixel Defects.....	29
8.6. Pixel Defect Tolerances.....	29
8.7. MURA.....	29
<b>9. Cleaning and Troubleshooting</b> .....	<b>30</b>
9.1. Cleaning.....	30
9.2. Troubleshooting.....	31
<b>10. Technical Specifications</b> .....	<b>32</b>



# 1. Unpacking and Installation

## 1.1. Unpacking

- This product is packed in a carton, together with the standard accessories.
- Any other optional accessories will be packed separately.
- Due to the size and weight of this display it is recommended for two people to move it.
- After opening the carton, ensure that the contents are complete and in good condition.

## 1.2. Package Contents

Please verify that you received the following items with your package content:

- LCD display
- CD ROM
- Remote control with AAA batteries
- Power cord (1.8 m)
- VGA cable (1.8 m)
- RS232 cable (1.8 m)
- Daisy Chain Cable (1.8 m)
- Quick start guide
- Logo guider
- Edge Alignment Kit-1: 1PCS
- Edge Alignment Kit-2: 2PCS
- Thumb Screw: 8PCS



\* The supplied power cord varies depending on destination.

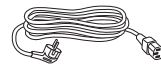

Power Cord



Daisy Chain Cable

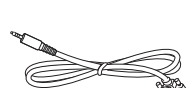

RS232 Cable



Video Signal Cable  
(D-SUB to D-SUB Cable)



Quick start guide



Thumb Screw



Edge Alignment Kit-1



Edge Alignment Kit-2



CD ROM

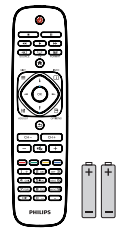

Remote Control  
and AAA Batteries



Logo guider

### NOTES:

- For all other regions, apply a power cord that conforms to the AC voltage of the power socket and has been approved by and complies with the safety regulations of the particular country.
- You might like to save the package box and packing material for shipping the display.

## 1.3. Installation Notes

- Due to the high power consumption, always use the plug exclusively designed for this product. If an extended line is required, please consult your service agent.
- The product should be installed on a flat surface to avoid tipping. The distance between the back of the product and the wall should be maintained for proper ventilation. Avoid installing the product in the kitchen, bathroom or any other places with high humidity so as not to shorten the service life of the electronic components.
- The product can normally operate only under 3000m in altitude. In installations at altitudes above 3000m, some abnormalities may be experienced.

## 1.4. Installing and Removing Table Stands (optional)

### To install table stands:

1. Ensure your display is powered off.
2. Spread a protective sheet on a flat surface.
3. Grab the carrying handles and place the display face-down on the protective sheet.
4. After inserting the stand in the guide block, tighten the screws on both sides of the display.

NOTE: The longer side of the stand should face the front of the display.

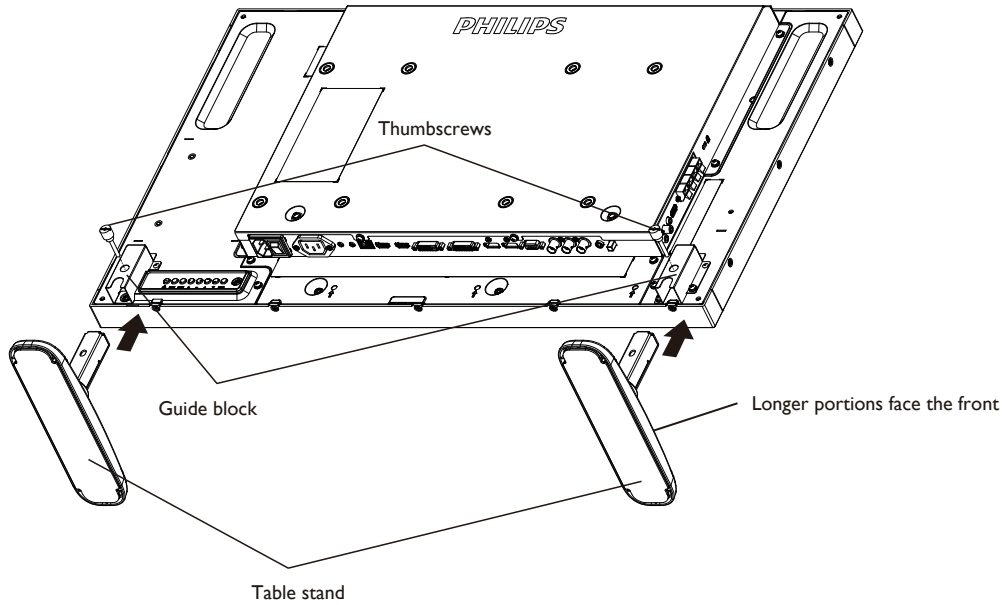

### To remove table stands:

1. Power off the display.
2. Spread a protective sheet on a flat surface.
3. Grab the carrying handles and place the display face-down on the protective sheet.
4. Remove screws using a screwdriver and place them in a safe place for reuse.

## 1.5. Mounting on a Wall

To mount this display to a wall, you will have to obtain a standard wall-mounting kit (commercially available). We recommend using a mounting interface that complies with TUV-GS and/or UL1678 standard in North America.

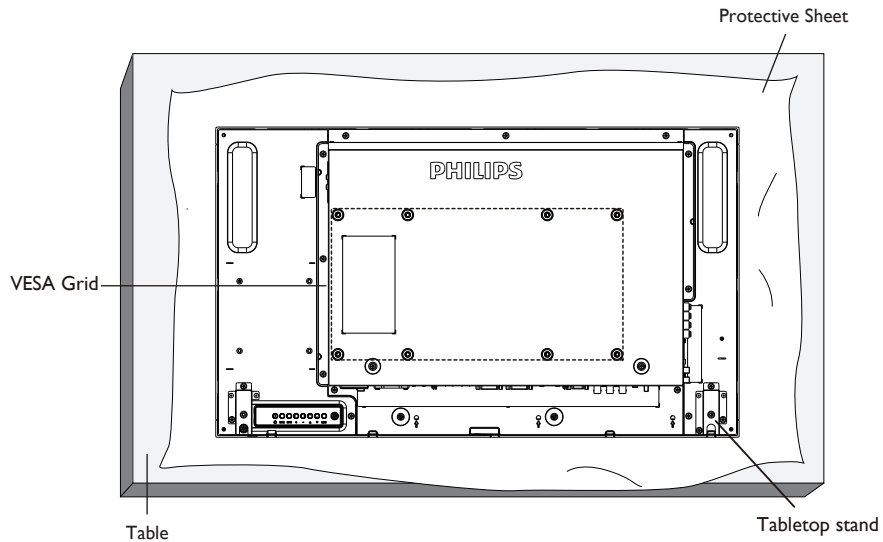

1. Lay a protective sheet on a table, which was wrapped around the display when it was packaged, beneath the screen surface so as not to scratch the screen face.
2. Ensure you have all accessories for mounting this display (wall mount, ceiling mount, table stand, etc).
3. Follow the instructions that come with the base mounting kit. Failure to follow correct mounting procedures could result in damage to the equipment or injury to the user or installer. Product warranty does not cover damage caused by improper installation.
4. For the wall-mounting kit, use M6 mounting screws (having a length 10 mm longer than the thickness of the mounting bracket) and tighten them securely.

### 1.5.1. VESA Grid

<b>BDL3260EL</b>	400(H) × 200(V) mm
	200(H) × 200(V) mm

#### Caution:

To prevent the display from falling:

- For wall or ceiling installation, we recommend installing the display with metal brackets which are commercially available. For detailed installation instructions, refer to the guide received with the respective bracket.
- To lessen the probability of injury and damage resulting from fall of the display in case of earthquake or other natural disaster; be sure to consult the bracket manufacturer for installation location.

#### Ventilation Requirements for enclosure locating

To allow heat to disperse, leave space between surrounding objects as shown in the diagram below.

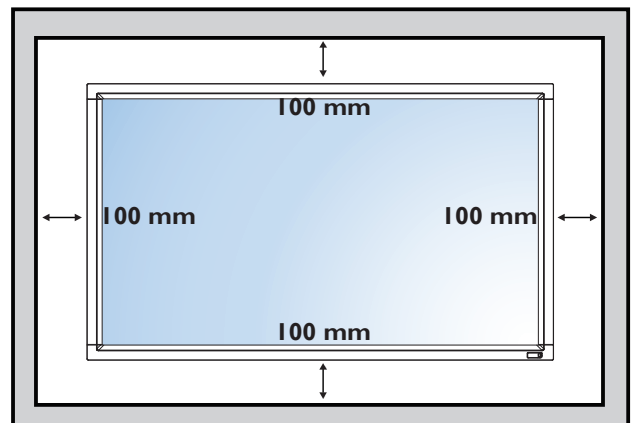

## 1.6. Mounting in Portrait Position

This display can be installed in portrait position.

1. Remove the table stand, if attached.
2. Rotate 90 degrees clockwise. The "**PHILIPS**" logo should be on the LEFT side when facing the display.

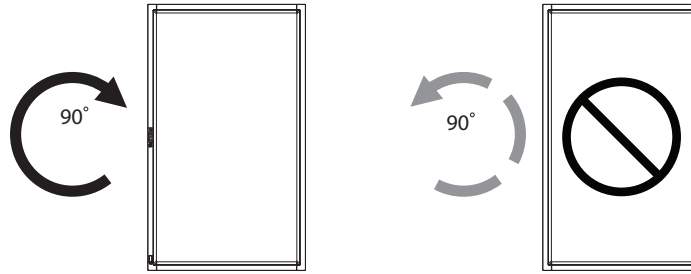

### 1.6.1. How to use the logo guider for portrait position

1. Put the guider on the lower-left corner of the front bezel of the display. Fold down both of its edges.
2. Peel off the protective film at the back of the "**PHILIPS**" logo sticker. Hold and press the guider with your left hand. Put the "**PHILIPS**" logo sticker with its adhesive side down into the logo hole with your right hand, and press to make it stick tightly onto the front bezel.
3. Remove the guider.

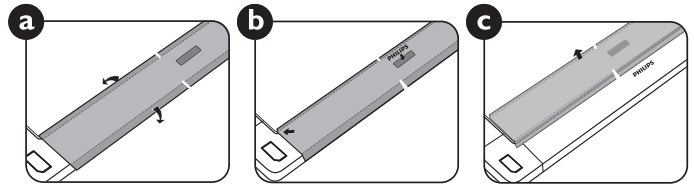

### 1.6.2. How to remove the logo

1. Prepare a piece of paper with a cutting area of logo as a protector to prevent the front bezel from scratching.
2. Using a knife, carefully remove the logo sticker with the paper placing beneath.
3. Tear off the logo sticker.

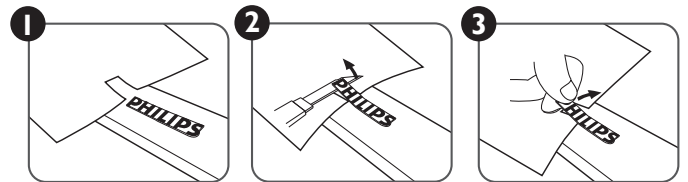

NOTE: When installing the display on a wall, please consult a professional technician for proper installation. We accept no liability for installations not performed by a professional technician.

## 1.7. Operating Instructions of Edge Alignment Kit

### 1.7.1. Installing Edge Alignment Kit

- Before install edge alignment kit, displays must be mounted to video wall frame correctly.
- Using "Thumb Screw" for easy installing.
- Using "Edge Alignment Kit-1" on adjacent four displays.

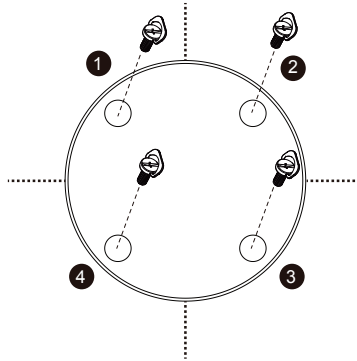

- Using "Edge Alignment Kit-2" on adjacent two displays.
- Install the "Edge Alignment Kit-2" with 2 PCS of M4 screw, and make sure the longer edge faced to the outer side of display

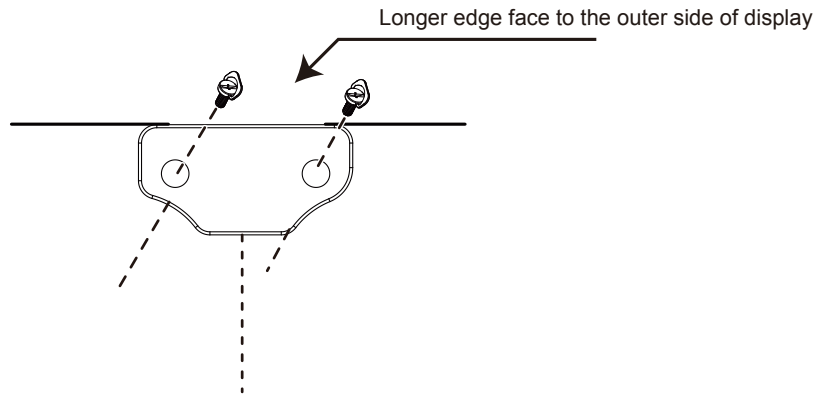

NOTE: When installing the edge alignment kit, please consult a professional technician for proper installation. We accept no liability for installations not performed by a professional technician.



## 2. Parts and Functions

### 2.1. Control Panel

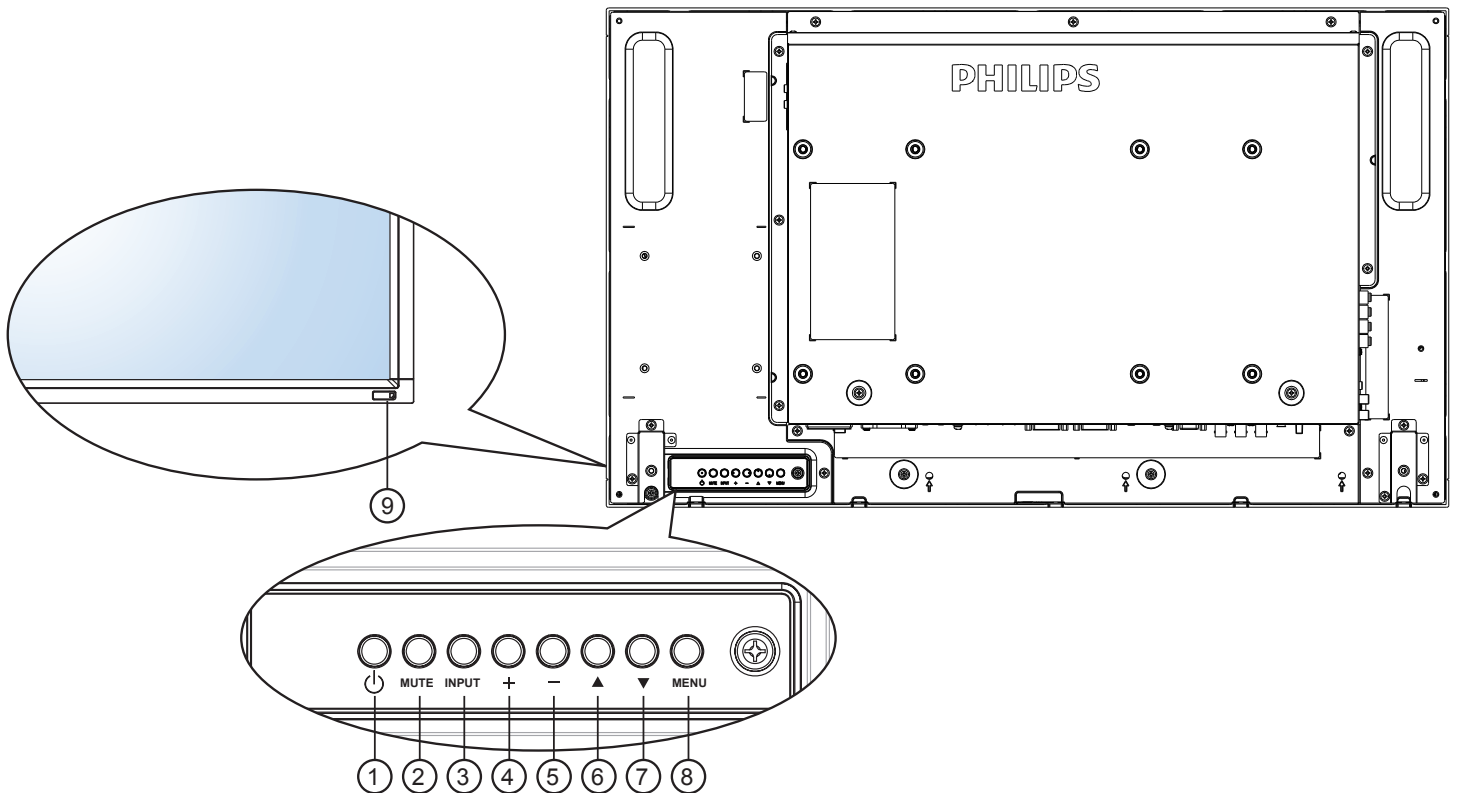

#### ① [Power] button

Use this button to turn the display on or put the display to standby.

#### ② [MUTE] button

Switch the audio mute ON/OFF.

#### ③ [INPUT] button

Choose the input source.

- Used as [OK] button in the On-Screen-Display menu.

#### ④ [+] button

Increase the adjustment while OSD menu is on, or increase the audio output level while OSD menu is off.

#### ⑤ [-] button

Decrease the adjustment while OSD menu is on, or decrease the audio output level while OSD menu is off.

#### ⑥ [▲] button

Move the highlight bar up to adjust the selected item while OSD menu is on.

#### ⑦ [▼] button

Move the highlight bar down to adjust the selected item while OSD menu is on.

#### ⑧ [MENU] button

Return to previous menu while OSD menu is on, or to activate the OSD menu when OSD menu is off.

#### ⑨ Remote control sensor and power status indicator

- Receives command signals from the remote control.
- Indicates the operating status of the display without OPS:
  - Lights green when the display is turned on
  - Lights red when the display is in standby mode
  - Lights amber when the display enters APM mode
  - When {SCHEDULE} is enabled, the light blinks green and red
  - If the light blinks red, it indicates that a failure has been detected
  - Lights off when the main power of the display is turned off

## 2.2. Input/Output Terminals

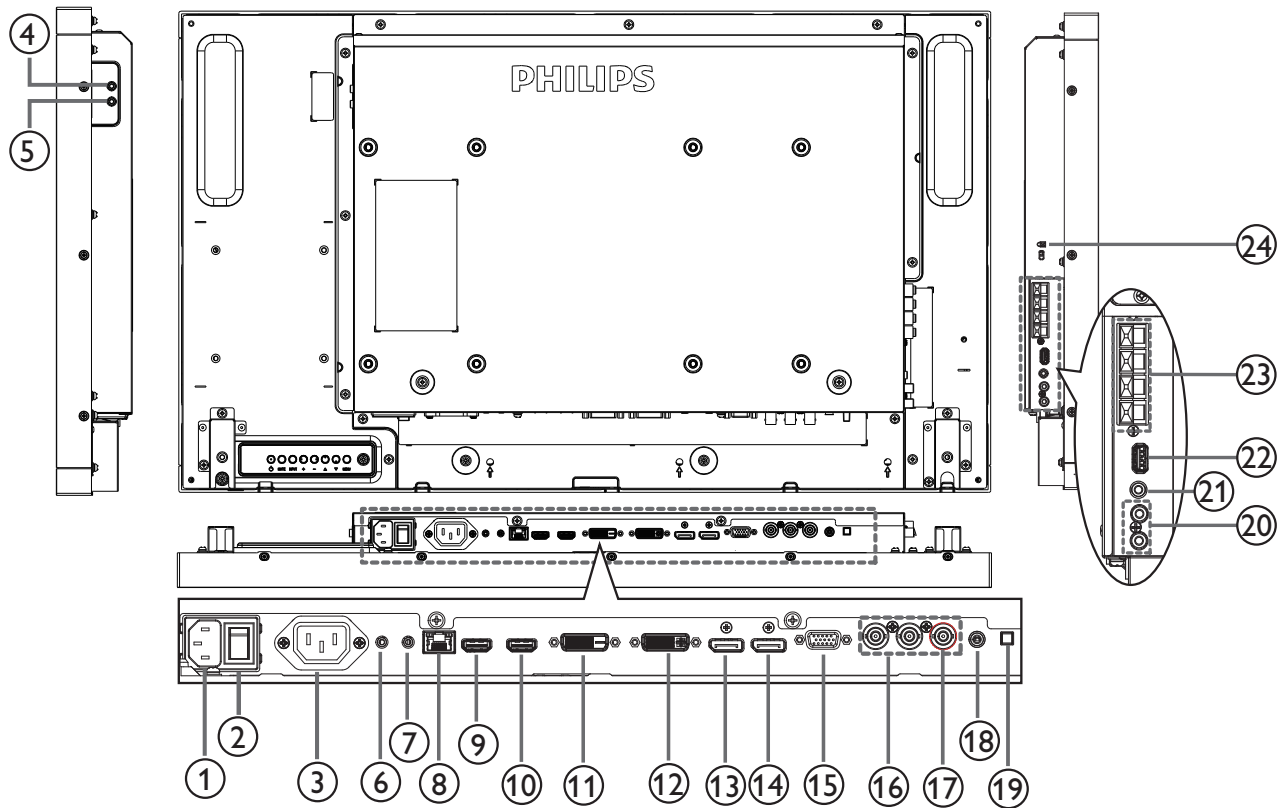

**① AC IN**

AC power input from the wall outlet.

**② MAIN POWER SWITCH**

Switch the main power on/off.

**③ AC OUT**

AC power output supply to the AC IN jack of a media player.

**④ IR IN / ⑤ IR OUT**

IR signal input / output for the loop-through function.

**NOTES:**

- This display's remote control sensor will stop working if the jack [IR IN] is connected.
- To remotely control your A/V device via this display, refer to page 15 for IR Pass Through connection.

**⑥ RS232C IN / ⑦ RS232C OUT**

RS232C network input / output for the loop-through function.

**⑧ RJ-45**

LAN control function for the use of remote control signal from control center.

**⑨ HDMI1 IN / ⑩ HDMI2 IN**

HDMI video/audio input.

**⑪ DVI IN**

DVI-D video input.

**⑫ DVI OUT / VGA OUT**

DVI or VGA video output.

**⑬ DisplayPort IN / ⑭ DisplayPort OUT**

DisplayPort video input / output.

**⑮ VGA IN (D-Sub)**

VGA video input.

**⑯ COMPONENT IN (BNC)**

Component YPbPr video source input.

**⑰ Y/CVBS**

Video source input.

**⑱ PC LINE IN**

Audio input for VGA source (3.5mm stereo phone).

**⑲ SPEAKER SWITCH**

Internal speaker on/off switch.

**⑳ AUDIO IN**

Audio input from external AV device (RCA).

**㉑ AUDIO OUT**

Audio output to external AV device.

**㉒ USB PORT**

Connect your USB storage device.

**㉓ SPEAKERS OUT**

Audio output to external speakers.

**㉔ KENSINGTON LOCK**

Used for security and theft prevention.

## 2.3. Remote Control

### 2.3.1. General functions

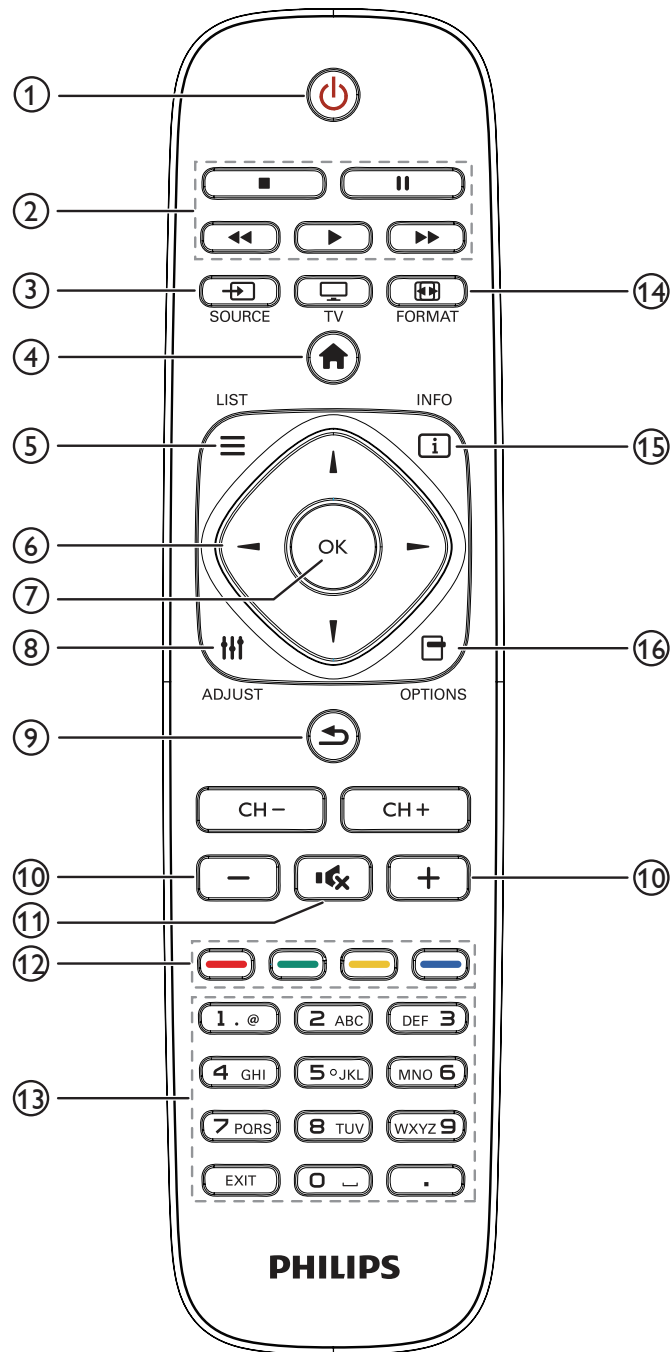

- ① **[POWER] POWER button**  
Turn the display on or put the display to standby.
- ② **[PLAY] buttons**  
Control playback of media files.
- ③ **[SOURCE] SOURCE button**  
Choose input source. Press [←] or [→] button to choose from **USB, Network, HDMI 1, HDMI 2, DisplayPort, Card OPS, DVI-D, YPbPr, AV, or VGA**. Press [OK] button to confirm and exit.
- ④ **[HOME] HOME button**  
Access the OSD menu.
- ⑤ **[LIST] LIST button**  
No function.
- ⑥ **[NAVIGATION] NAVIGATION buttons**  
Navigate through menus and choose items.
- ⑦ **[OK] button**  
Confirm an entry or selection.
- ⑧ **[ADJUST] ADJUST button**  
Access currently available options, picture and sound menus.
- ⑨ **[BACK] BACK button**  
Return to the previous menu page or exit from the previous function.
- ⑩ **[VOLUME] VOLUME button**  
Adjust volume.
- ⑪ **[MUTE] MUTE button**  
Press to turn the mute function on/off.
- ⑫ **[COLOR] COLOR buttons**  
Choose tasks or options.
- ⑬ **[NUMERIC] buttons**  
Enter text for network setting.
- ⑭ **[FORMAT] FORMAT button**  
Change picture format.
- ⑮ **[INFO] INFO button**  
Display information about current activity.
- ⑯ **[OPTIONS] OPTIONS button**  
Access currently available options, picture and sound menus.

### 2.3.2. Inserting the batteries in the remote control

The remote control is powered by two 1.5V AAA batteries.

To install or replace batteries:

1. Press and then slide the cover to open it.
2. Align the batteries according to the (+) and (-) indications inside the battery compartment.
3. Replace the cover.

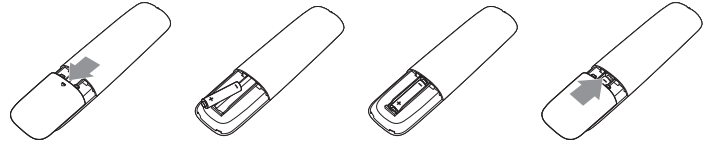

#### Caution:

The incorrect use of batteries can result in leaks or bursting. Be sure to follow these instructions:

- Place "AAA" batteries matching the (+) and (-) signs on each battery to the (+) and (-) signs of the battery compartment.
- Do not mix battery types.
- Do not combine new batteries with used ones. It causes shorter life or leakage of batteries.
- Remove the dead batteries immediately to prevent them from liquid leaking in the battery compartment. Don't touch exposed battery acid, as it can damage your skin.

NOTE: If you do not intend to use the remote control for a long period, remove the batteries.

### 2.3.3. Handling the remote control

- Do not subject to strong shock.
- Do not allow water or other liquid to splash the remote control. If the remote control gets wet, wipe it dry immediately.
- Avoid exposure to heat and steam.
- Other than to install the batteries, do not open the remote control.

### 2.3.4. Operating range of the remote control

Point the top of the remote control toward the display's remote control sensor when pressing a button.

Use the remote control within a distance of less than 8m/26ft from the display's sensor, and a horizontal and vertical angle of less than 30 degrees.

NOTE: The remote control may not function properly when the remote control sensor on the display is under direct sunlight or strong illumination, or when there is an obstacle in the path of signal transmission.

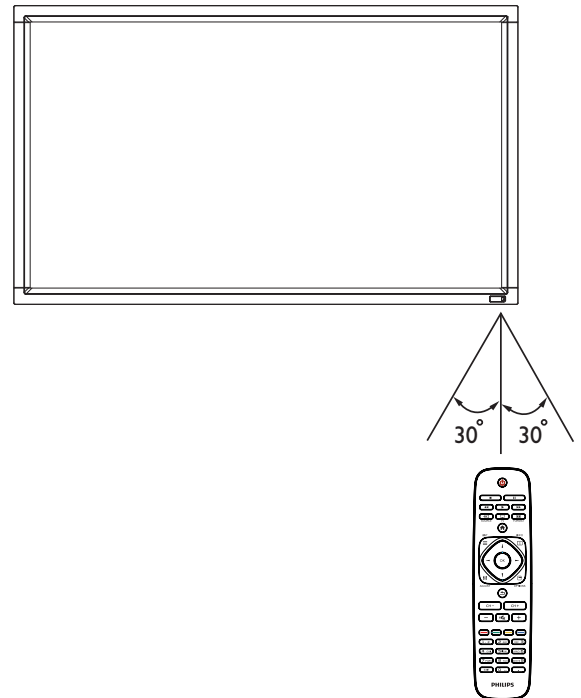

### 3. Connecting External Equipment

#### 3.1. Connecting External Equipment (DVD/VCR/VCD)

##### 3.1.1. Using COMPONENT video input

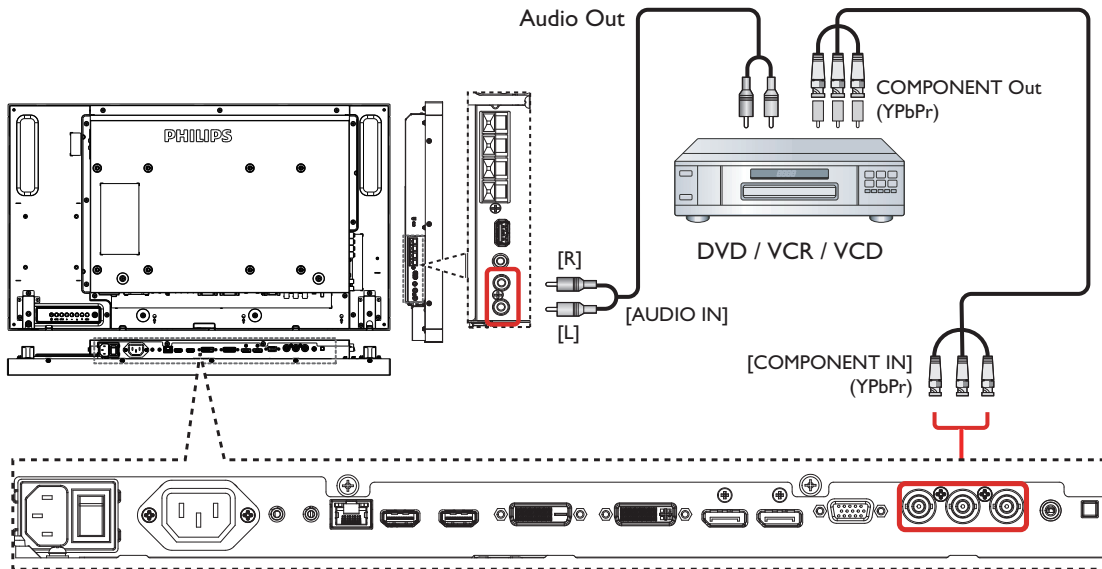

##### 3.1.2. Using Video Source input

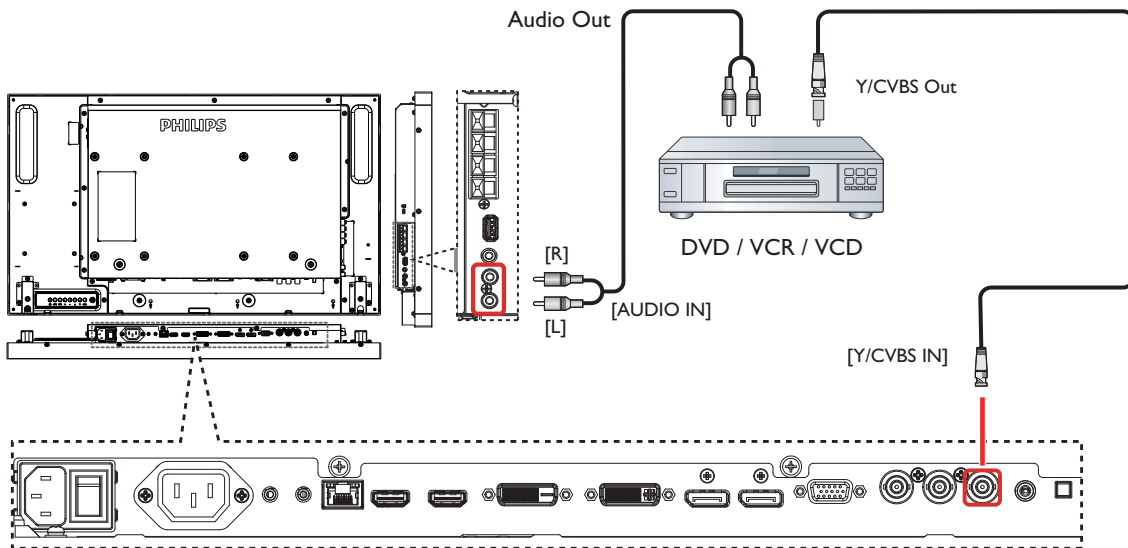



### 3.1.3. Using HDMI video input

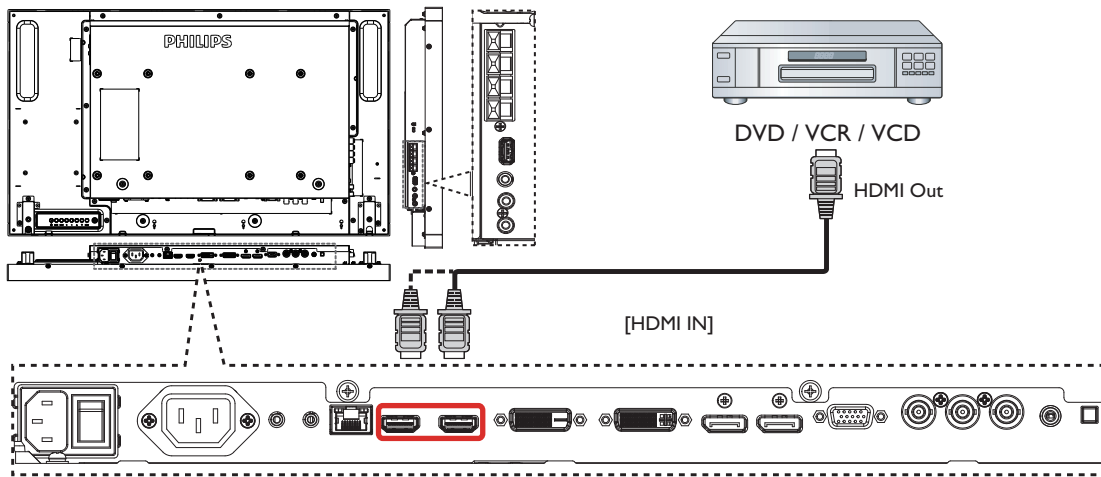

## 3.2. Connecting a PC

### 3.2.1. Using VGA input

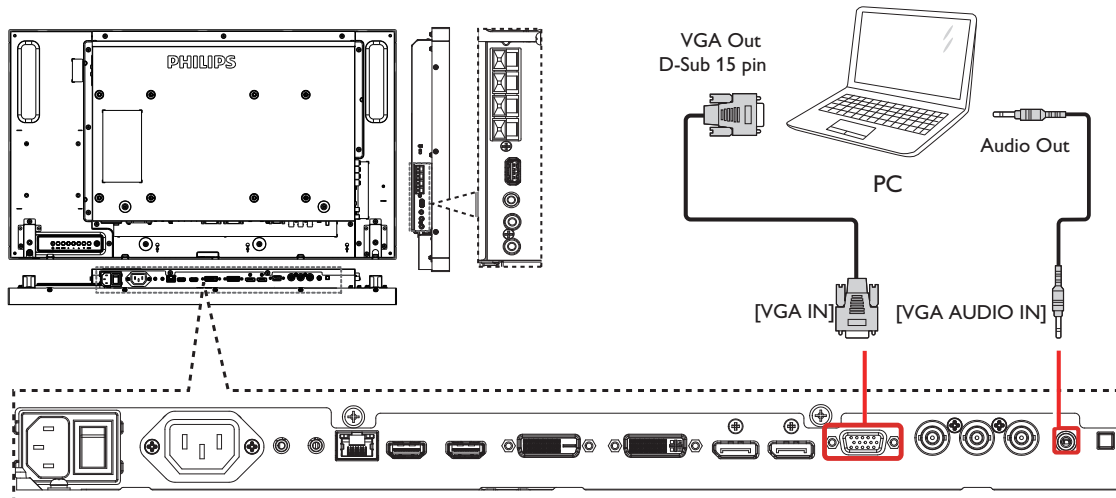

### 3.2.2. Using DVI input

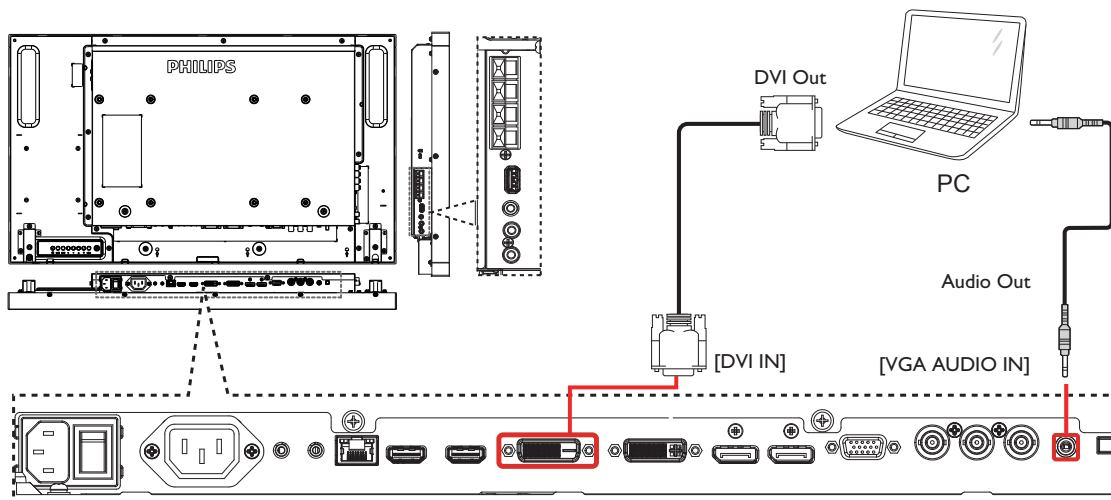

### 3.2.3. Using HDMI input

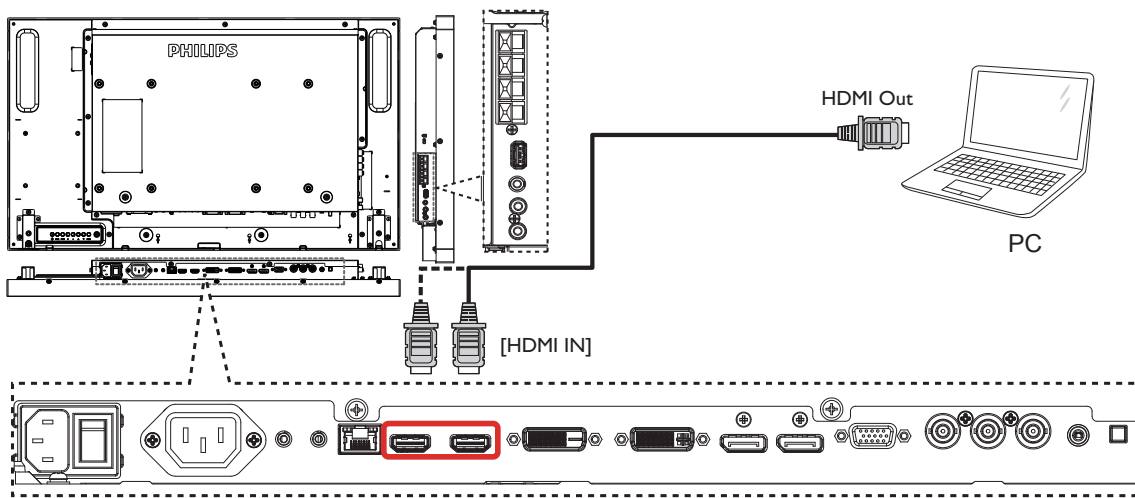

### 3.2.4. Using DisplayPort input

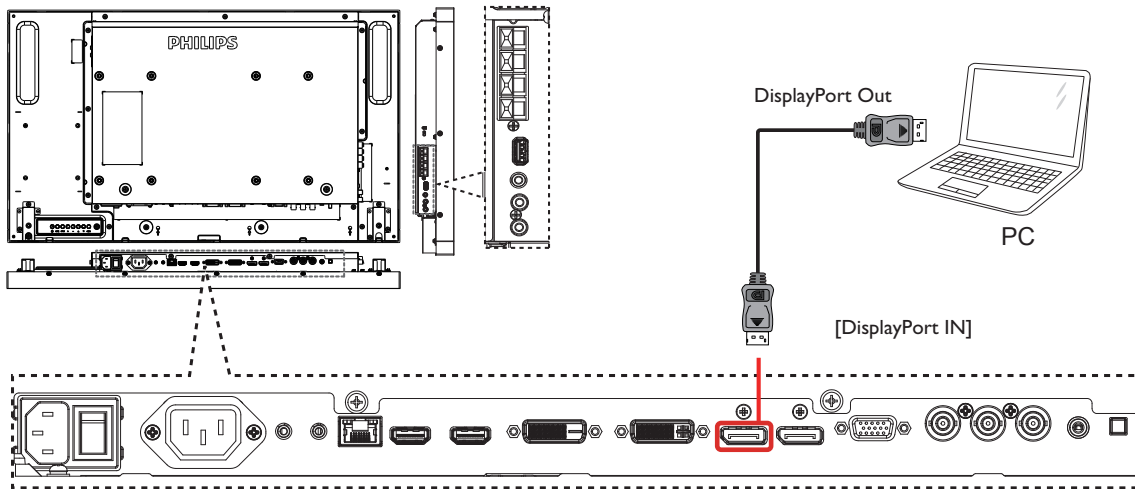

## 3.3. Connecting Audio Equipment

### 3.3.1. Connecting external speakers

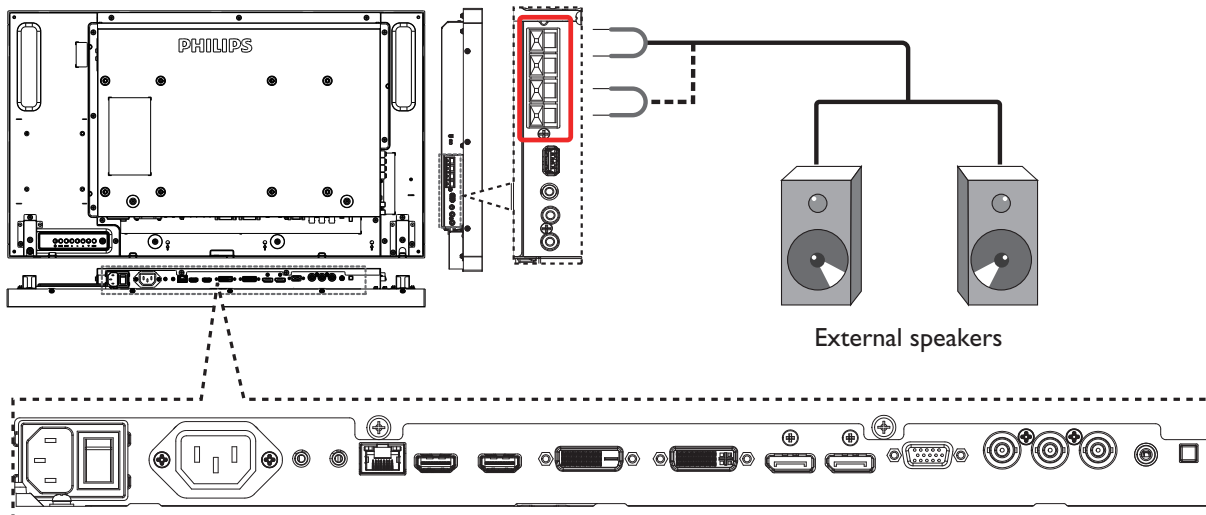

### 3.3.2. Connecting an external audio device

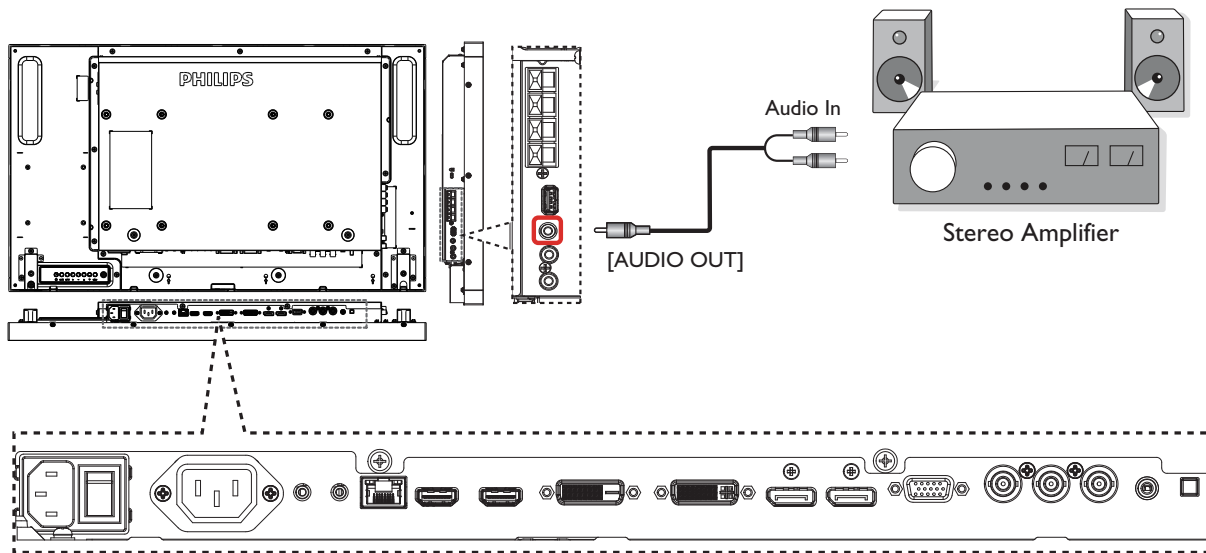

### 3.4. Connecting Multiple Displays in a Daisy-chain Configuration

You can interconnect multiple displays to create a daisy-chain configuration for applications such as a video wall.

NOTE: Maximum 25 displays (5x5) can be used in a daisy-chain configuration.

#### 3.4.1. Display control connection

Connect the [RS232C OUT] connector of DISPLAY 1 to the [RS232C IN] connector of DISPLAY 2.

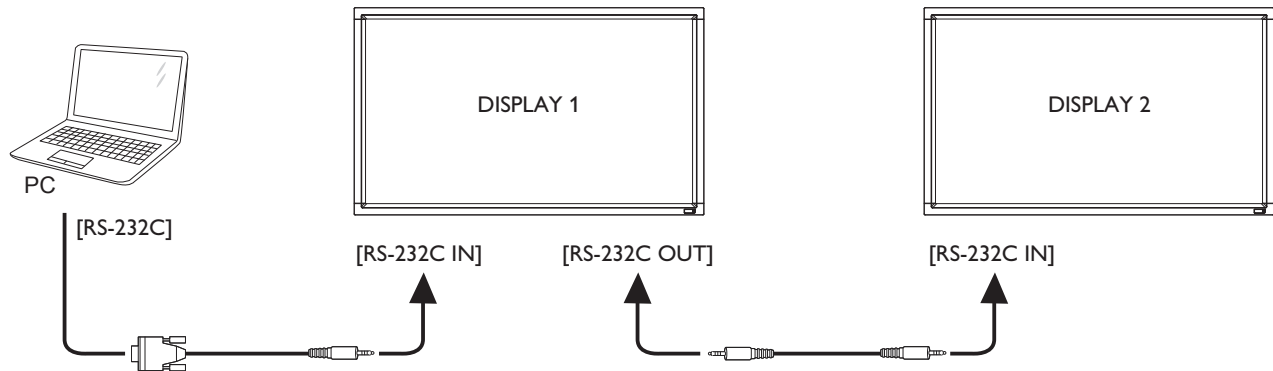

#### 3.4.2. Digital video connection

Connect the [DVI OUT / VGA OUT] connector of DISPLAY 1 to the [DVI IN] connector of DISPLAY 2.

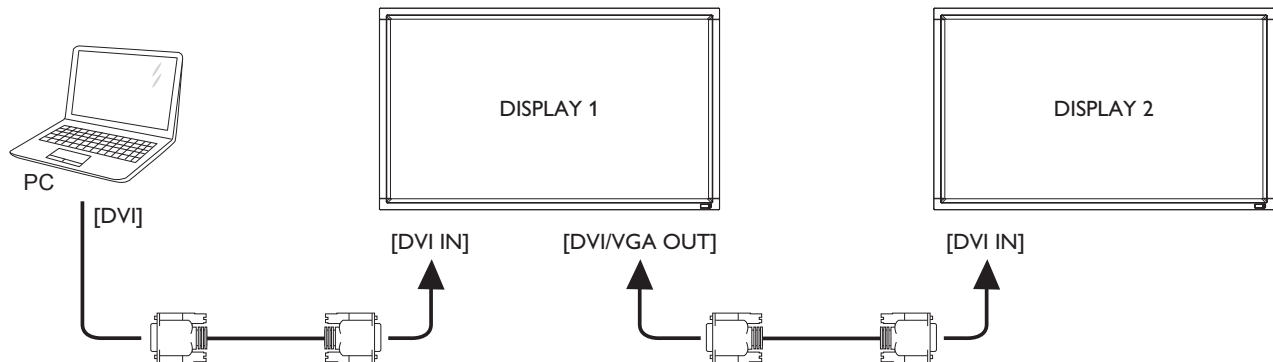

Connect the [DP OUT] connector of DISPLAY 1 to the [DP IN] connector of DISPLAY 2.

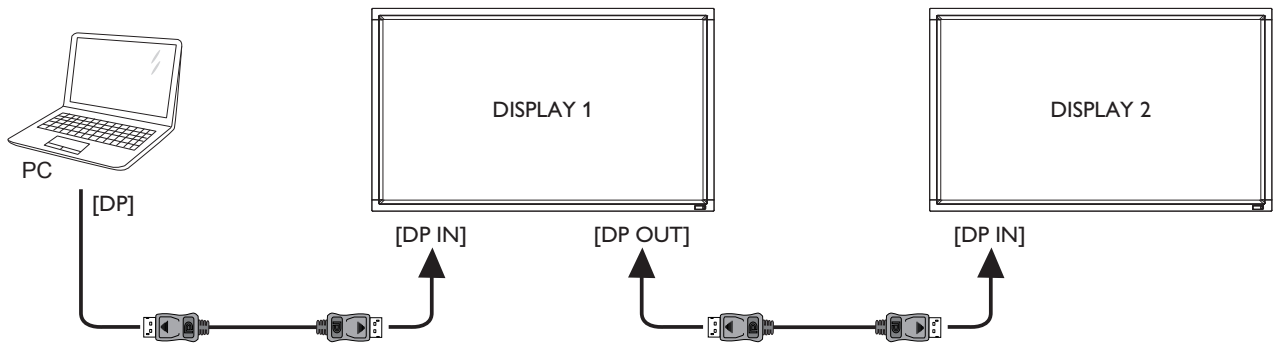

Connect the [HDMI OUT] connector of DISPLAY 1 to the [DVI IN] connector of DISPLAY 2.

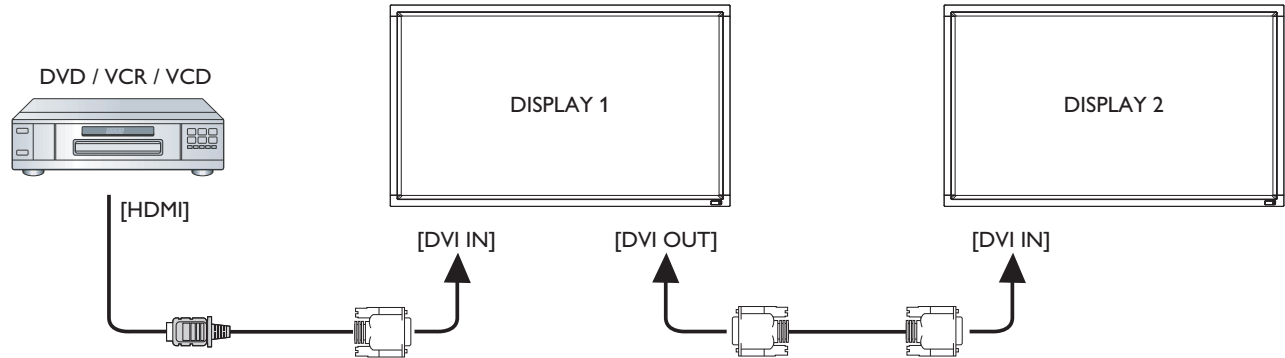

### 3.4.3. Analog video connection

Connect the [DVI OUT / VGA OUT] connector of DISPLAY 1 to the [VGA IN] connector of DISPLAY 2.

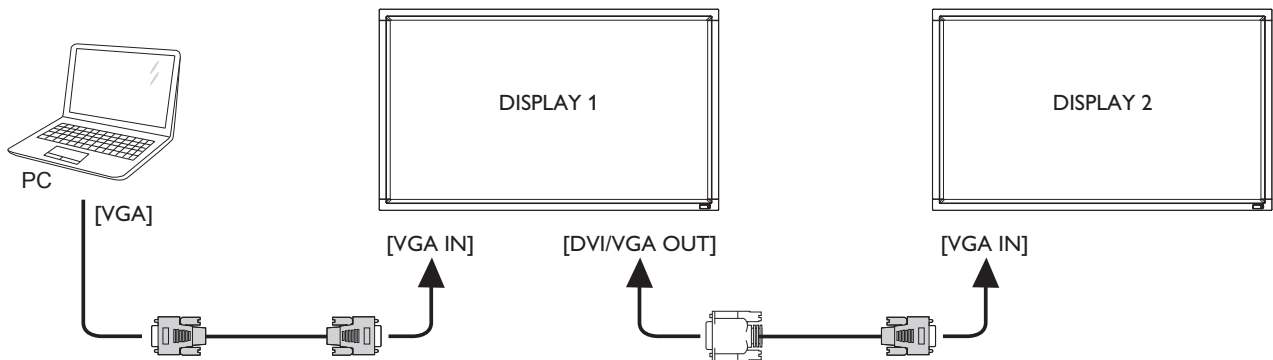

### 3.5. IR connection

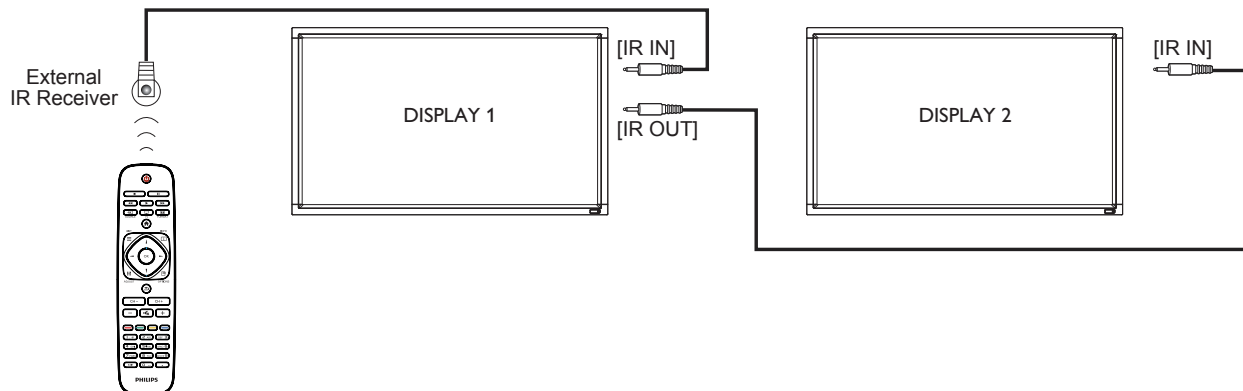

NOTE: This display's remote control sensor will stop working if the [IR IN] is connected.

### 3.6. IR Pass-through Connection

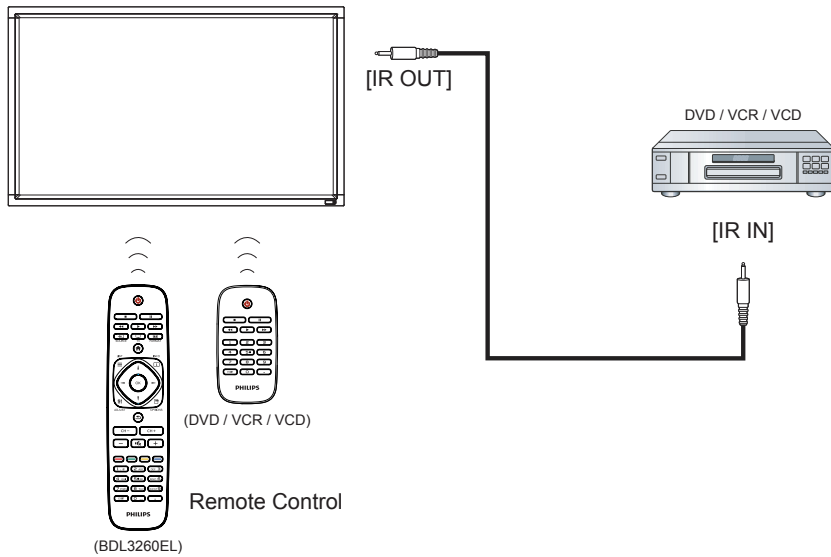

### 3.7. Wire-connecting to Network

If you connect this display to a home network, you can play photos, music and videos from your computer. See *Play multimedia files via Local Area Network* (Page 16) for more detail.

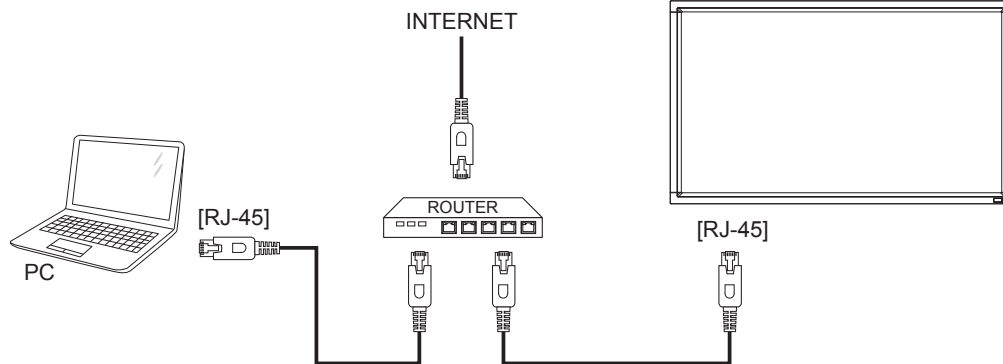

#### To setup the network:

1. Switch on the router and switch on its DHCP setting.
2. Connect the router to this display with an Ethernet cable.
3. Press [**HOME**] button on the remote control, then select **Setup**.
4. Select **Connect to network**, then press [**OK**] button.
5. Follow the on-screen instructions to install the network.
6. Wait for this display to find the network connection.
7. If you are prompted, agree to the "End User Licence Agreement".

NOTE: Connecting with a shielded CAT-5 Ethernet cable to comply with the EMC directive.



## 4. Operation

**NOTE:** The control button described in this section is mainly on the remote control unless specified otherwise.

### 4.1. Watch the Connected Video Source

See page 10 for external equipments connection.

1. Press [**→**] SOURCE button.
2. Press [**←**] or [**→**] button to choose a device, then press [OK] button.

### 4.2. Change Picture Format

You can change the picture format to suit the video source. Each video source has its available picture formats.

The available picture formats depend on the video source:

1. Press [**≡**] FORMAT button.
2. Press [**▲**] or [**▼**] button to choose a picture format, then press [OK] button.
  - {Auto zoom}: Enlarge the picture to fill the screen. Recommended for minimal screen distortion but not for HD or PC.
  - {Movie expand 16:9}: Scale 4:3 format to 16:9. Not recommended for HD or PC.
  - {Wide screen}: Shows wide screen format content unstretched. Not recommended for HD or PC.
  - {Unscaled}: Provide maximum detail for PC. Only available when PC mode is selected in the {Picture} menu.
  - {4:3}: Display the classic 4:3 format.

### 4.3. Choose your Preferred Picture Settings

1. While this display is playing video source, press [**≡**] ADJUST button.
2. Press [**←**] or [**→**] button to choose **Picture style**, then press [OK] button.
3. Press [**▲**] or [**▼**] button to choose an option, then press [OK] button:
  - {Personal}: Apply your personalised picture settings.
  - {Vivid}: Rich and dynamic settings, ideal for daytime viewing.
  - {Natural}: Natural picture settings.
  - {Standard}: Default settings that suit most environments and types of video.
  - {Movie}: Ideal settings for movies.
  - {Photo}: Ideal settings for photos.
  - {Energy saving}: Settings that conserve the most energy.

### 4.4. Choose your Preferred Sound Settings

1. While this display is playing video source, press [**≡**] ADJUST button.
2. Press [**←**] or [**→**] button to choose **Sound style**, then press [OK] button.
3. Press [**▲**] or [**▼**] button to choose an option, then press [OK] button:
  - {Personal}: Apply your personalised sound settings.

- {Original}: Settings that suit most environments and types of audio.
- {Movie}: Ideal settings for movies.
- {Music}: Ideal settings for listening to music.
- {Game}: Ideal settings for games.
- {News}: Ideal settings for spoken audio, such as the news.

### 4.5. Play multimedia files via Local Area Network

To play files via Local Area Network, you will need:

- A wired home network, connected with a Universal Plug and Play (uPnP) router.
- Optional: A LAN cable that connects your display to your home network.
- A media server running on your computer.
- Appropriate settings on your computer firewall to allow you to run the media server.

#### 4.5.1. Set up the network

1. Connect your display and the computer to the same home network. See illustration below to connect your display to a network.
2. Switch on your computer and the router:
  - **Single display setup:**

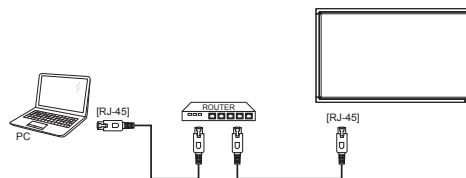

- **Multiple display setup:**

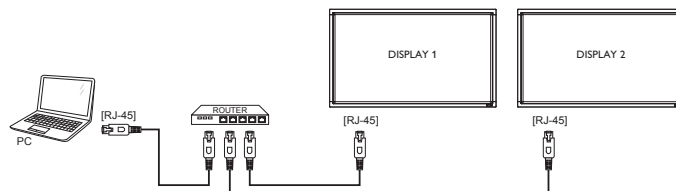

**NOTE:** If the apparatus does not return to DLNA mode due to external electrical disturbances (e.g. electrostatic discharge), user intervention is required.

#### Set up media sharing

1. Install a media server on your computer to share media files. These are some media servers:
  - For PC: Windows Media Player 11 (or higher) or TVersity
  - For Mac: Twonky
2. Switch on media sharing on your computer using the media server. For more information on how to set up the media server, refer to the website of the media server.

#### 4.5.2. How to use DLNA-DMP

1. Please connect display and your PC to the same router via RJ-45.
2. Run windows media player. Set stream handling as public sharing.

- Press [**HOME**] button, Then, choose **Setup** and press [**OK**] button.

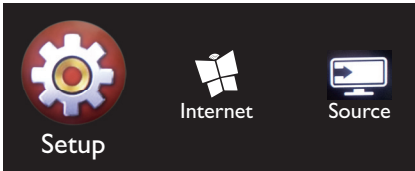

- Choose **Connect to network** and press [**OK**] button.

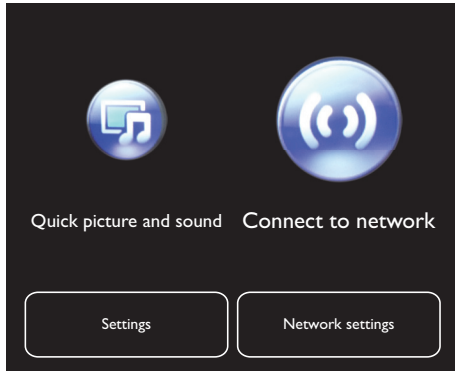

- Choose **Connect** and press [**OK**] button.



- Choose **Wired** and press [**OK**] button.

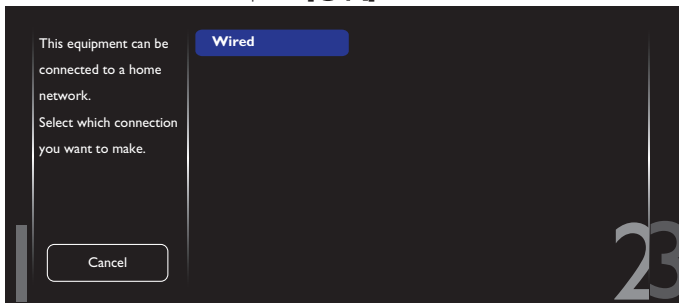

- Press [**OK**] button to close.

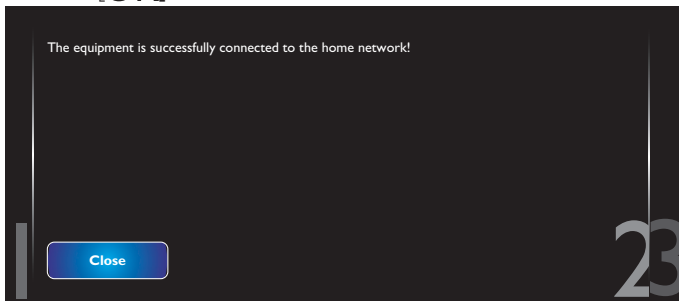

- Press [**OK**] button, then done.

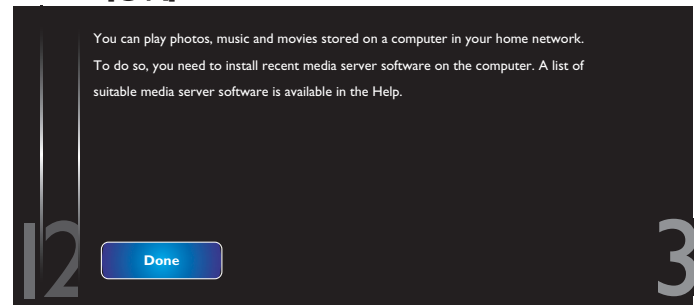

### Play files from display

- Press [**HOME**] button, Then, choose **Source** and press [**OK**] button.

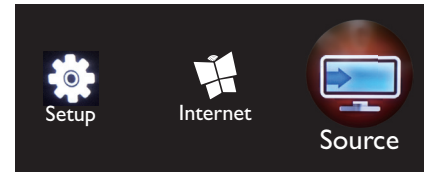

- Choose **Browse network** and press [**OK**] button.

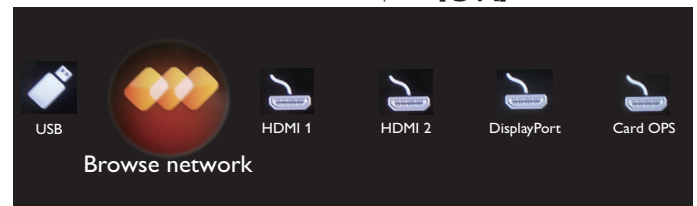

- Now, you can see all the PC's connected to the same router on the screen. Choose the right one.
- Press [**UP**] and [**RIGHT**] to choose the directory and files to play.
- You can connect up to 4 displays to the same PC and play same media stream.

We suggest to use DLNA-DMP function via wired network for the sake of higher security and sufficient network bandwidth.

### 4.5.3. How to use DLNA-DMR from PC

- Press [**HOME**] button, and go to **Setup** menu.
- Choose **Network Settings** and press [**OK**] button.

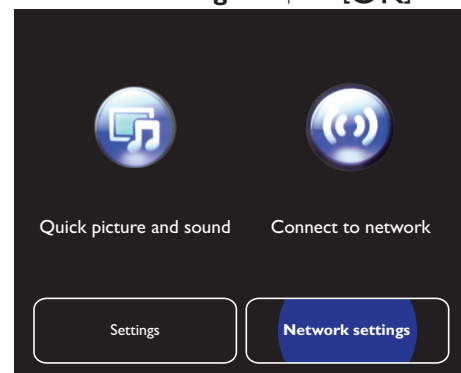

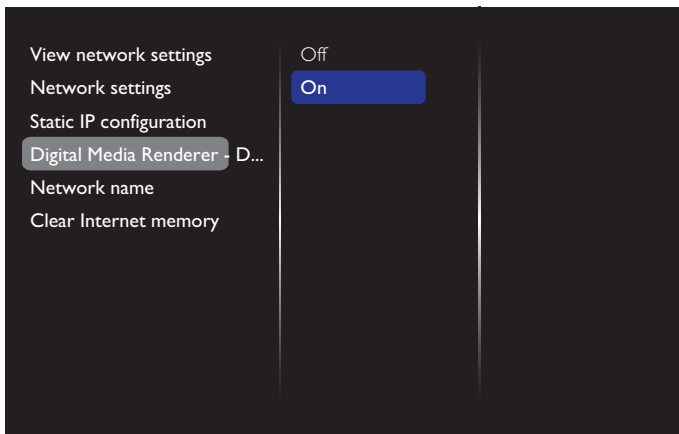
3. Set **DMR** as **ON**.

## 4. Set the name of your display.

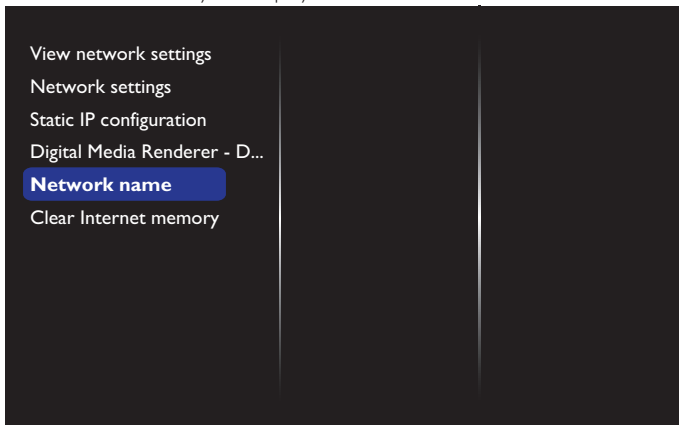

5. Press **[HOME]** HOME button, and go to **Source** menu. Then, choose **Browse network** and press **[OK]** button.
6. On your PC, go to **Network and Sharing Center**, and click **Choose homegroup and sharing options**.
7. Check the media formats. Then, click **Choose media streaming options....**
8. Go to **Advanced sharing settings**, and check **Turn on network discovery**.
9. Now, go to the directory of your media files. Choose the media file by right click. On the submenu from **Play To**, You can find all displays connected to your network. Choose the display, and click the media file to play.

**Play files**

1. Press **[SOURCE]** SOURCE button.
2. Choose **Browse network**, and press **[OK]** button.
3. Choose a file from the content browser, and press **[OK]** button to start playing.
4. Press the **[PLAY]** buttons on the remote control to control playing.

**Tips:**

- Choose the top bar to filter your files by type.
- Choose **Sort** to arrange the files by album name, artist, or other fields.

- To clear the list of offline media servers, press **[OPTIONS]** OPTIONS button. Then, choose **Clear offline servers** and press **[OK]** button.

**4.6. Play multimedia files from USB device**

1. Connect your USB device to the USB port on the display.

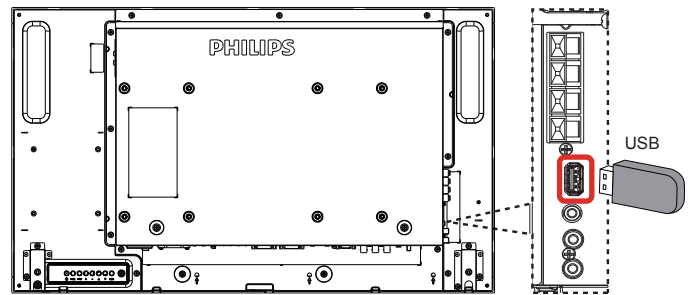

2. Press **[SOURCE]** SOURCE button, choose **USB**, and press **[OK]** button.

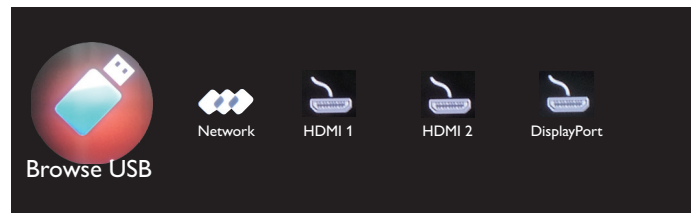

3. The connected USB device is detected automatically for all its playable files, which will be automatically sorted into 3 types: **Music**, **Movie**, and **Photo**.
4. Press **[BACK]** BACK button to go up to the top layer in the screen. Press **[LEFT]** or **[RIGHT]** button to choose the file type. Press **[OK]** button to enter its play list.
5. Choose the file you want. Press **[OK]** button to start playing.
6. Follow the on-screen instruction to control the play option.
7. Press **[PLAY]** buttons (**[STOP]** **[PAUSE]** **[REWIND]** **[PLAY]** **[FAST FORWARD]**) to control playing.

**4.7. Play options****4.7.1. Playing music files**

1. Choose **Music** in the top bar.



2. Choose one music track, and press **[OK]** button.
  - To play all the tracks in a folder, choose one music file. Then, press **[PLAY ALL]** to **Play All**.
  - To skip to the next or previous track, press **[NEXT]** or **[PREVIOUS]** button.
  - To pause the track, press **[OK]** button. Press **[OK]** button again to resume playback.
  - To skip backward or forward 10 seconds, press **[LEFT]** or **[RIGHT]** button.
  - To search backward or forward, press **[REWIND]** or **[FAST FORWARD]** button, press repeatedly to toggle between different speeds.
  - To stop the music, press **[STOP]** button.

## Music options

While you play music, press [ ] **OPTIONS** button, then press [OK] button to choose an option:

- **{Shuffle}**: Enable or disable random play of tracks.
- **{Repeat}**: Choose **{Repeat}** to play a track or an album repeatedly, or choose **{Play once}** to play a track once.

**NOTE:** To view information about a song (for example, title, artist or duration), choose the song, then press [i] **INFO** button. To hide the information, press [i] **INFO** button again.

### 4.7.2. Playing movie files

1. Choose [ ] **Movie** in the top bar.



2. Choose a video, and press [OK] button.
  - To play all the videos in a folder; choose one video file. Then, press [ ] to **Play All**.
  - To pause the video, press [OK] button. Press [OK] button again to resume playback.
  - To skip backward or forward 10 seconds, press [←] or [→] button.
  - To search backward or forward, press [◀◀] or [▶▶] button, press repeatedly to toggle between different speeds.
  - To stop the video, press [ ] button.

## Movie options

While playing video, press [ ] **OPTIONS** button, then press [OK] button to choose an option:

- **{Subtitles}**: Choose the available subtitle settings.
- **{Subtitle Language}**: Choose the language for subtitles if available.
- **{Shuffle}**: Enable or disable random play of video files.
- **{Repeat}**: Choose **{Repeat}** to play the video file repeatedly or **{Play once}** to play the video file once.
- **{Status}**: To view information about a video (for example, played position, duration, title, or date).

### 4.7.3. Playing photo files

1. Choose [ ] **Photo** in the top bar.



2. Choose a photo thumbnail, then press [OK] button.

## Start a slideshow

If there are multiple photos in a folder; choose a photo. Then, press [ ] to **Play All**.

- To skip to the previous or next photo, press [←] or [→] button, and then press [OK] button.
- To stop the slideshow, press [ ] button.

## Slideshow options

While you play a slideshow, press [ ] **OPTIONS** button, then press [OK] button to choose an option:

- **{Shuffle}**: Enable or disable random display of pictures in the slideshow.
- **{Repeat}**: Choose **{Repeat}** to watch a slideshow repeatedly or **{Play once}** to watch once.
- **{Slideshow Time}**: Choose the displaying time for each photo in the slideshow.
- **{Slideshow Transitions}**: Choose the transition from one photo to the next.

## 4.8. How to use Opera browser (HTML5)

1. Press [ ] **HOME** button, and choose **Internet** and press [OK] button.

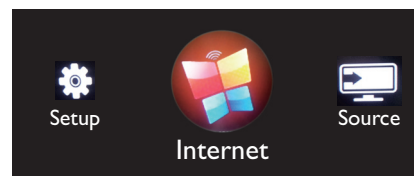

2. Move the cursor to URL address bar. Press [OK] button and it will pop out the on-screen keyboard. You can move the cursor to enter the URL address. After finishing the URL address, choose **Done**.

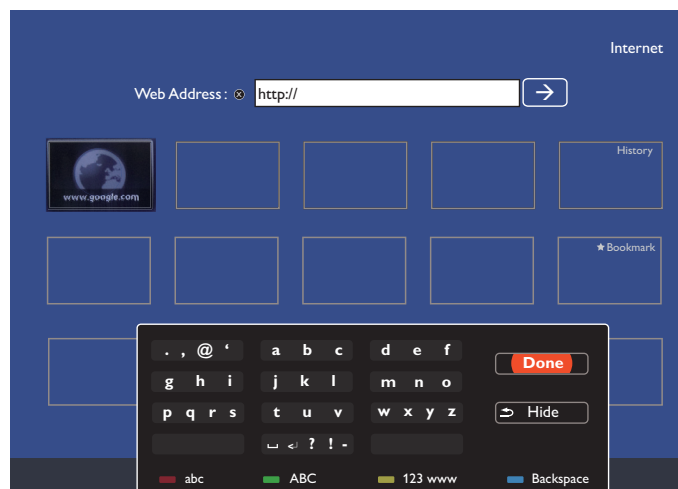

3. Move the cursor to "→" icon and press [OK] button.

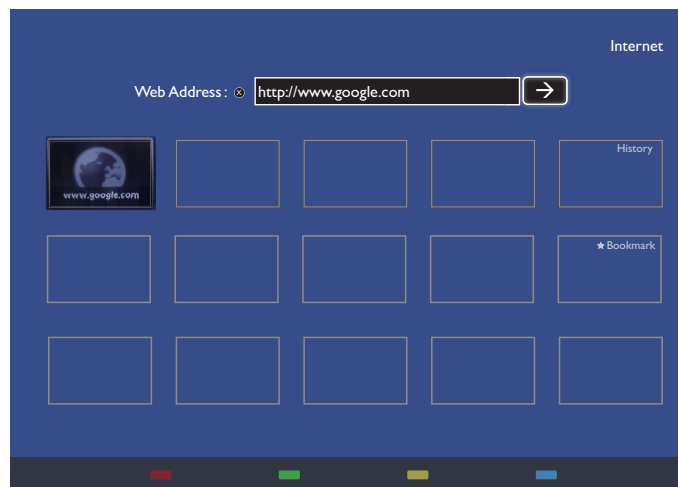

4. Now, you can see the web page.

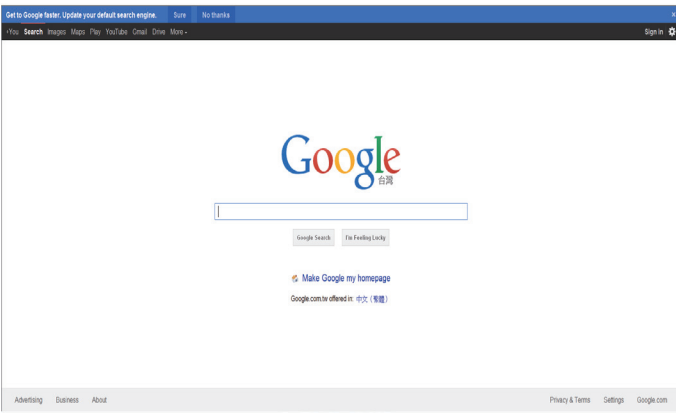

#### NOTES:

- The Opera browser does not support FLASH format.
- The browser is not a video source. It will not stay at the browser screen after you restart the display.

## 5. Change your settings

Using the remote control:

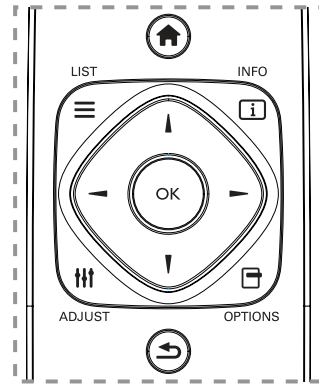

1. Press [**HOME**] button to display the OSD menu.
2. Press [**←**] or [**→**] button to choose **Setup**. Press [**OK**] button to enter.
3. Press [**▲**] [**▼**] [**←**] or [**→**] button to choose **Quick picture and sound**, **Settings**, **Connect to network**, or **Network settings**. Press [**OK**] button to enter.
4. Press [**▲**] [**▼**] [**←**] or [**→**] button to choose its menu item or to adjust its value. Press [**OK**] button to confirm.
5. Press [**↶**] **BACK** button to go back to the previous menu layer.
6. Press [**HOME**] button to exit the OSD menu.

Using the display's control buttons

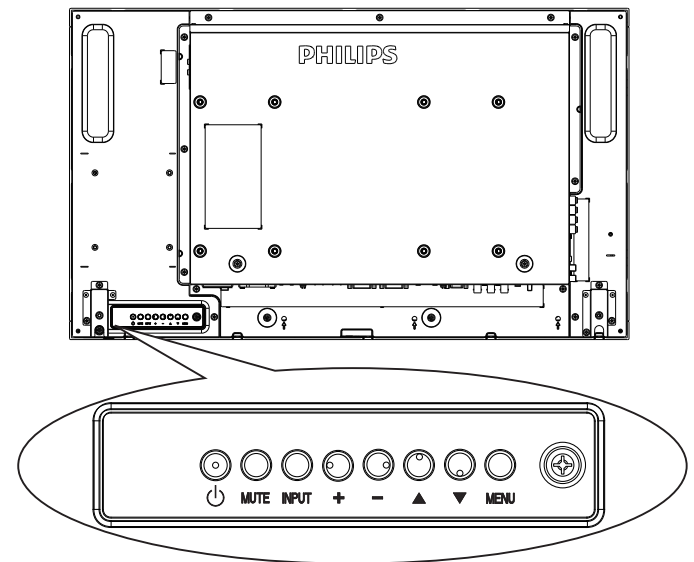

1. Press [**MENU**] button to display the OSD menu.
2. Press [**▲**] [**▼**] [**+**] or [**-**] button to choose menu item or adjust its value.
3. Press [**INPUT**] button to confirm menu selection and enter its submenu.
4. Press [**MENU**] button to exit the OSD menu.

### 5.1. Quick picture and sound

You can choose picture and sound settings with the help of the settings assistant, which demonstrates the effect of your chosen setting immediately.

1. Press [**HOME**] HOME button to display the OSD menu.
2. Choose **Setup**. Press [**OK**] button.
3. Choose **Quick picture and sound**. Press [**OK**] button.
4. Choose **Continue**, then press [**OK**] button
5. Follow the on-screen instructions to choose your preferred settings.

## 5.2. Settings

1. Press [**HOME**] HOME button, and go to **Setup** menu.
2. Choose **Settings** and press [**OK**] button.

### 5.2.1. Picture

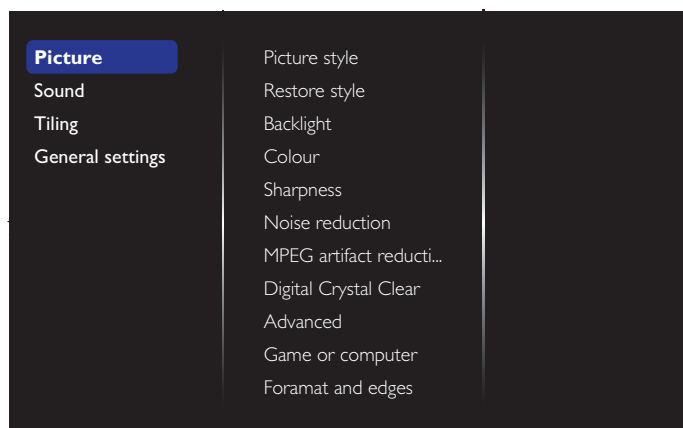

#### Picture style

Choose a predefined picture setting.

#### Restore style

Restore the last-selected predefined picture setting.

#### Backlight

Adjust the brightness of this display's backlight.

#### Colour

Adjust the colour saturation of the picture.

#### Sharpness

Adjust the sharpness of the picture.

#### Noise reduction

Choose the amount of noise reduction for the picture.

#### MPEG artifact reduction

Smoothen transitions and haziness in the digital picture.

#### Digital Crystal Clear

Fine-tune each pixel to match surrounding pixels and produce a brilliant, high-definition image.

- **{Advanced sharpness}**: Enable superior sharpness, especially on lines and contours in the picture.
- **{Dynamic contrast}**: Dynamically enhance the details in the dark, medium and light areas of the picture.
- **{Colour enhancement}**: Dynamically enhance the vividness and details of colours.

#### Advanced

Access advanced settings such as gamma, tint, video contrast and so on.

- **{Gamma}**: Adjust the non-linear setting for picture luminance and contrast.

- **{Tint}**: Change the colour balance.
- **{Custom tint}**: Customise colour balance setting. Only available if **{Tint}** → **{Custom}** is chosen.
- **{Video contrast}**: Adjust video contrast.
- **{Brightness}**: Adjust screen brightness.
- **{Hue}**: Adjust screen hue.

#### Game or computer

When viewing content from a connected game console, choose **{Game}** to apply game settings. When a computer is connected through HDMI, choose **{Computer}**.

Make sure that **{Format and edges}** → **{Picture format}** → **{Unscaled}** is selected so as to view maximum detail.

#### Format and edges

- **{Picture format}**: Change the picture format.

See page 16 for the descriptions about **Picture format**.

### 5.2.2. Sound

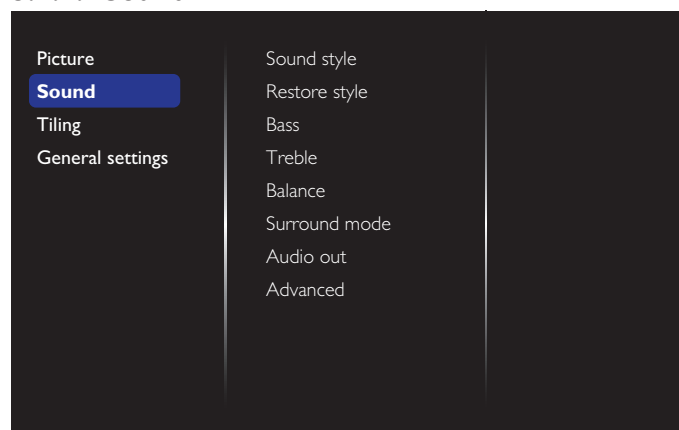

#### Sound style

Access predefined sound settings.

#### Restore style

Restore the last-selected predefined sound setting.

#### Bass

Adjust to increase or decrease lower-pitched sounds.

#### Treble

Adjust to increase or decrease higher-pitched sounds.

#### Balance

Adjust to emphasize left or right audio output balance.

#### Surround mode

Enhance your audio experience.

#### Audio out

Adjust audio output volume.

**Advanced**

Access advanced settings to enhance your audio experience.

- **{Auto volume leveling}**: Enable the reduction of sudden volume changes.
- **{Speaker settings}**: Turn on or off the internal speakers.
- **{Clear sound}**: Enhance sound quality.
- **{Audio out format}**: Choose the type of audio output through the digital audio output connector. (HDMI only)
- **{Audio out delay}**: Automatically sync the image on this display to the audio from a connected home theatre.
- **{Audio out offset}**: Adjust the setting for audio output delay. Available if **{Audio out delay}** is switched on.

**5.2.3. Tiling**

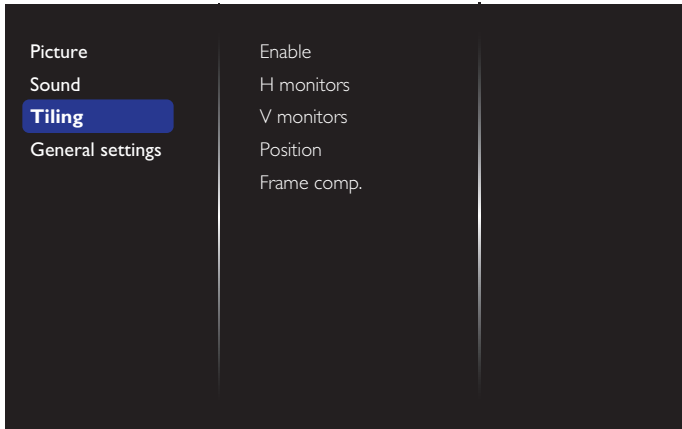

With this function you can create a single large-screen matrix (video wall) that consists of up to 100 sets of this display (up to 10-sets on the vertical and 10-sets on the horizontal sides).

**Enable**

Choose to **{On}** or **{Off}** the Tiling function. If **{On}**, the display will apply the settings in **{H monitors}**, **{V monitors}**, **{Position}**, and **{Frame comp.}**.

**H monitors**

Adjust displays on the horizontal side.

**V monitors**

Adjust displays on the vertical side.

**Position**

Adjust the position of this display in the screen matrix.

**Example: 2 x 2 screen matrix (4 displays)**

- H monitors = 2 displays
- V monitors = 2 displays

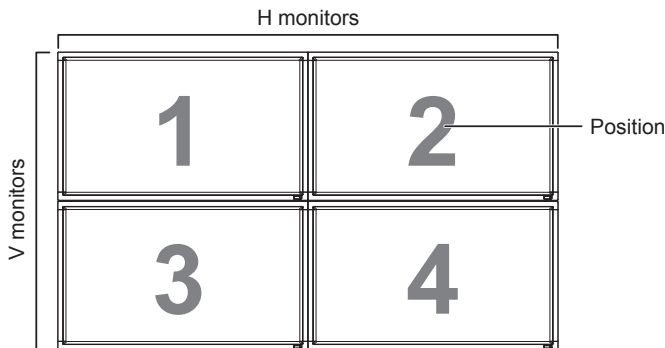

**Example: 5 x 5 screen matrix (25 displays)**

- H monitors = 5 displays
- V monitors = 5 displays

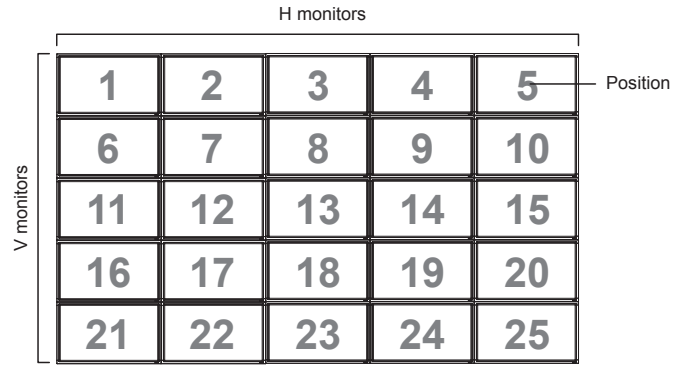

**Frame comp.**

Choose to turn the frame compensation function on or off. If selected **{On}**, the display will adjust the image to compensate for the width of the display bezels in order to accurately display the image.

**{On}**

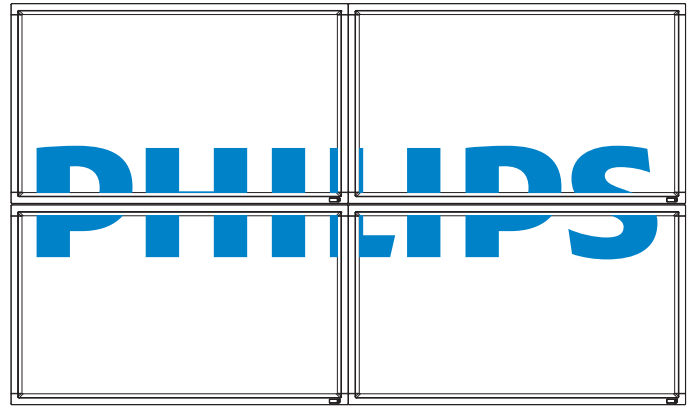

**{Off}**

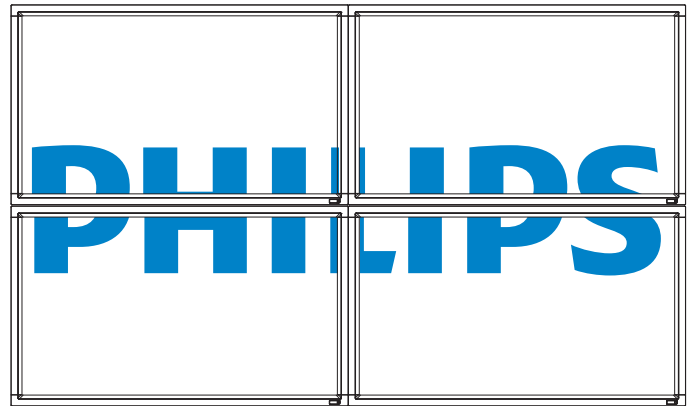

## 5.2.4. General settings

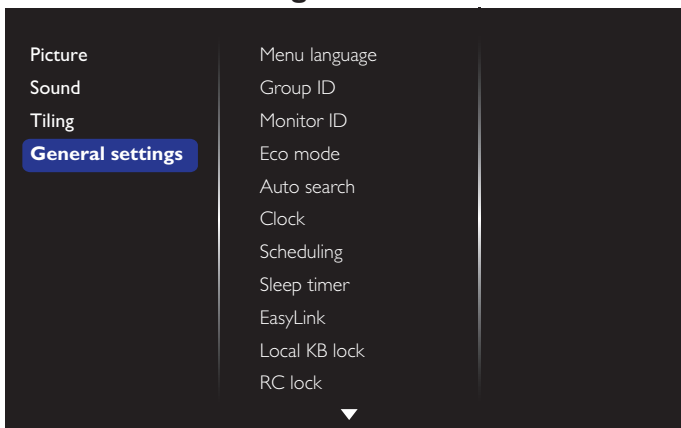

### Menu language

Choose language used for OSD menus.

### Monitor group

Adjust the group range between 1 to 255. The default setting is 255.

### Monitor ID

Adjust the ID number for controlling the display via the RS232C connection. Each display must have a unique ID number when multiple sets of this display are connected. Monitor ID number range is between 1 to 255. The default setting is 1.

### Eco mode

Set this display to reduce the power consumption automatically.

### Auto search

Choose to let this display detect and display available signal sources automatically.

### Clock

Set the current date and time for the display's internal clock.

### Scheduling

This function allows you to program up to 7 different scheduled time intervals for this display to activate.

You can set:

- Which input source the display will use for each scheduled activation period.
- The time for the display to turn on and turn off.
- The days in a week for the display to activate.

NOTES:

- We recommend you to set up current date and time in the {Clock} menu before using this function.
- After changing the {Clock} option in the {General settings} menu, you need to set this {Scheduling} again.

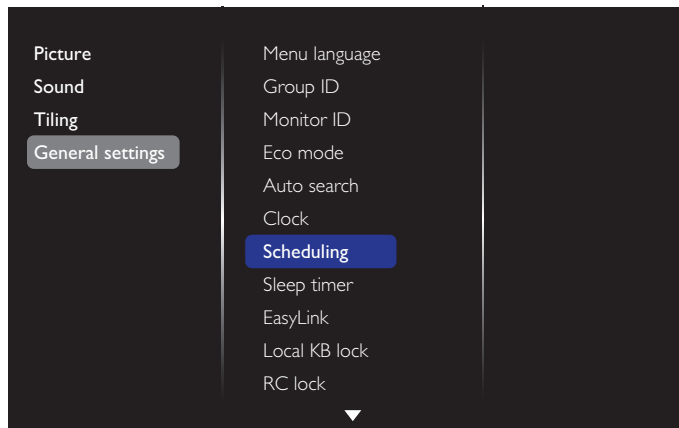

1. There are 7 schedule can be set. Go to **Status** and choose **On**.

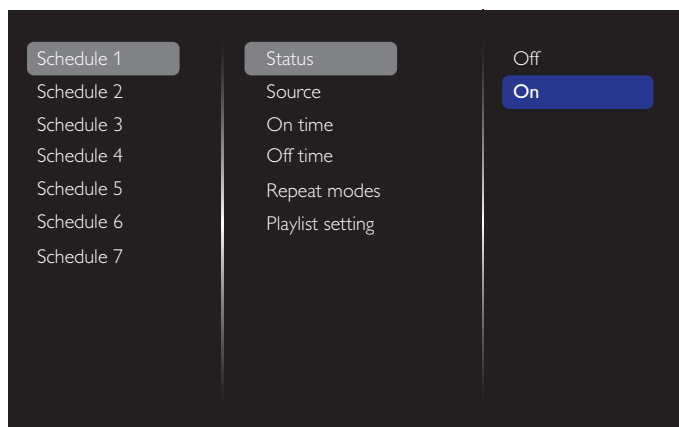

2. Go to **Source** and choose input source. If {Source} → {USB} is chosen. You need to set playlist. If {Source} → {BROWSER} is chosen. You need to set URL address.

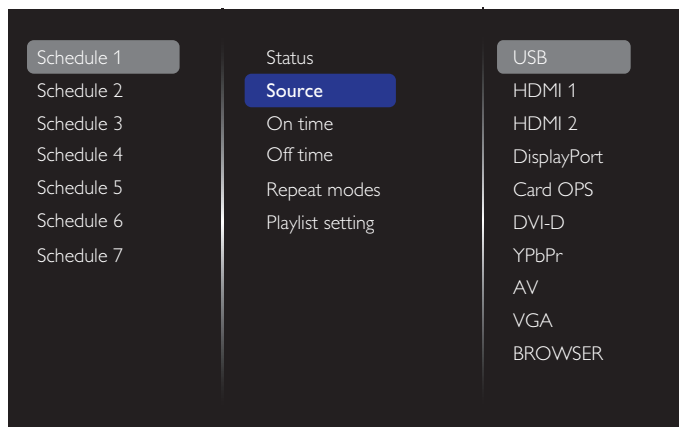

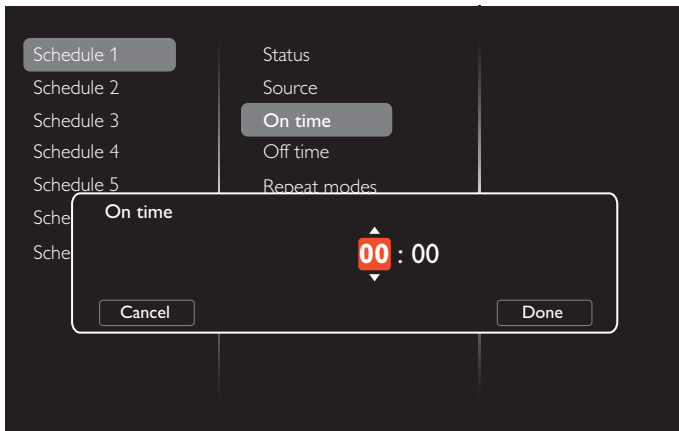
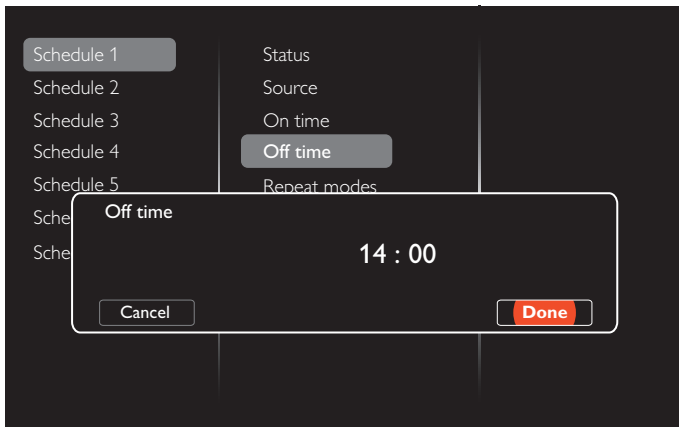
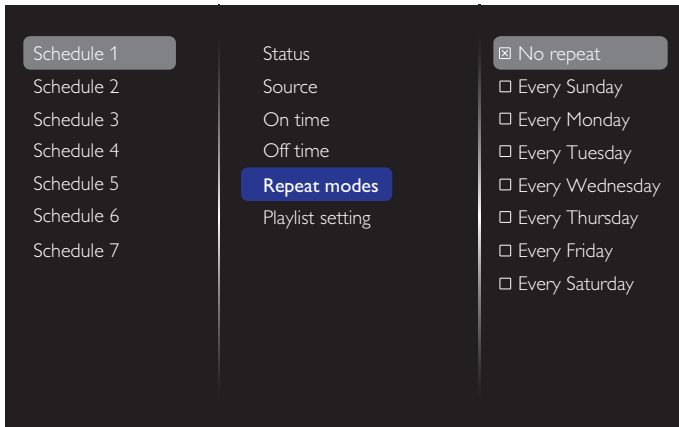
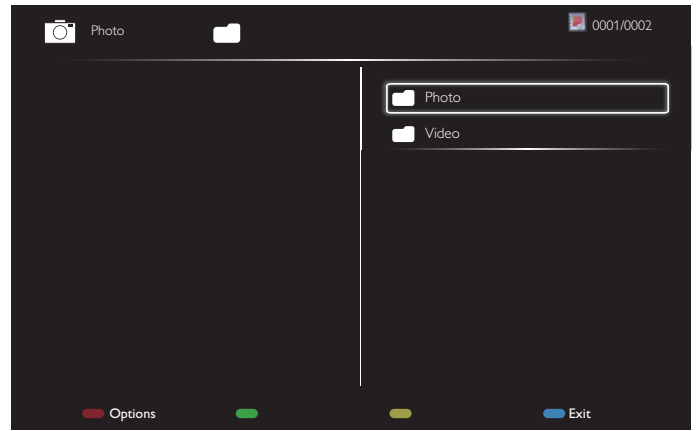

3. Set **On time**.4. Set **Off time**.5. Go to **Repeat modes** and choose.6. If {Source} → {USB} is chosen. Go to **Playlist setting**.

- Press **[U] [V]** buttons to choose files.
- Press **[←] [→]** buttons to switch Playlist and File Manager.
- Press **[OK]** button to set or clear the playlist.

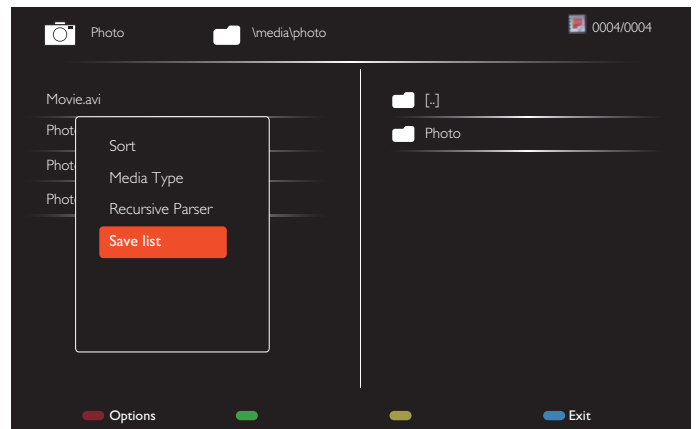
7. To save the playlist, press **[Red]** and choose **Save list**.

## NOTES:

- Each Playlist supports up to 30 files.
- Playlist will not be cleared after **{Factory settings}**. You have to manually remove the files or delete usb\_schedulinglist.txt in the USB.

**Sleep timer**

Switch off this display after a specified time.

**EasyLink**

Connect and control your HDMI-CEC compliant devices through HDMI port to this display with the same remote control.

**Auto adjust**

Use this function to automatically optimize the display of VGA input image.

NOTE: This item is functional for **VGA** input only.

**Local KB lock**

Choose to enable or disable the keyboard (control buttons) function of the display.

- **{Unlock}**: Enable the keyboard function.
- **{Lock all}**: Lock all keyboard function.
- **{Lock but volume}**: Disable all the keyboard function except the **[←]** and **[+]** button.

- **{Lock but power}**: Disable all the keyboard function except the **[⏻]** button.
- **{Lock all except volume and power}**: Disable all the keyboard function except the **[-]**, **[+]** and **[⏻]** button:

### RC lock

Choose to enable or disable the button function of the remote control.

- **{Unlock}**: Enable the keyboard function.
- **{Lock all}**: Lock all keyboard function.
- **{Lock but volume}**: Disable all the keyboard function except the **[-]** and **[+]** button.
- **{Lock but power}**: Disable all the keyboard function except the **[⏻]** POWER button.
- **{Lock all except volume and power}**: Disable all the keyboard function except the **[-]** **[+]** and **[⏻]** POWER button:

NOTE: To disable the lock function from **Local KB lock** or **-RC lock** item, press buttons **[HOME]** and **1 9 9 8** on the remote control.

### Pixel shift

For video input sources, you may choose **{On}** to move the screen image automatically to protect the display from "burn-in" or "after-image" symptoms 30 seconds after not operating the display.

### Smart power

Choose a backlight level to optimise dynamic power consumption and picture contrast.

The options are: **{Off}**, **{Standard}**, **{Best Power}**, **{Best Picture}**.

### Wake on lan

Choose **{On}** and you can turn on the display by network.

### Switch on state

Choose the display status used for the next time you connect the power cord.

- **{On}** - The display will turn on when the power cord is connected to a wall outlet.
- **{Standby}** - The display will remain Standby when the power cord is connected to a wall outlet.
- **{Last status}** - The display will return to the previous power status (on/off/standby) when removing and replacing the power cord.

### Light sensor

Choose **{On}** and the display will automatically adjust backlight.

### LED

Choose **{Off}** to turn off the indicator.

### Switch on delay

Adjust the power-on delaying time (in seconds) allows a sequential powering-on for each display by their ID number when multiple displays are connected.

### Logo

Choose **{Off}** and the display will not display the **PHILIPS** logo when you switch on.

### APM

Choose **{On}**. Then, when no signal, the display will automatically turn off.

### Information OSD

When you press **[⏻]** POWER button to turn on the display from standby mode or change the input signal, the information OSD is displayed on the upper left corner of the screen.

Choose **{Off}** to turn off this function.

### Factory settings

Reset all your customized settings to the factory defaults.

## 5.3. Network Settings

1. Press **[HOME]** HOME button, and go to **Setup** menu.
2. Choose **Network Settings** and press **[OK]** button.

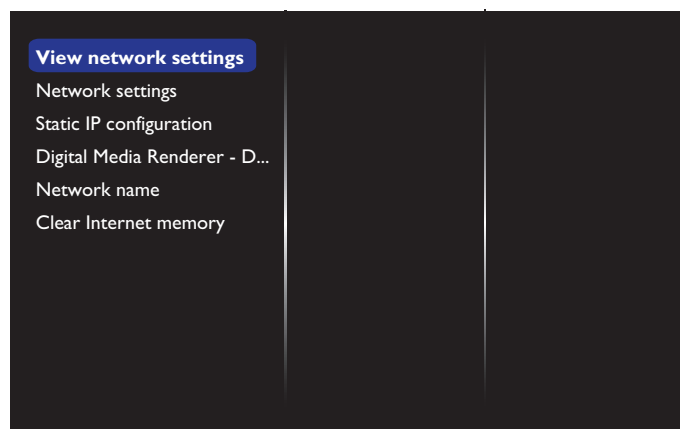

### View network settings

View connected network status.

### Network settings

**{Network configuration}**: Choose how this display should assign addresses to the network resources. The user can choose **{DHCP & Auto IP}** (suggested) or **{Static IP}**.

### Static IP Configuration

Define **{IP address}**, **{Netmask}**, **{Gateway}**, **{DNS1}**, and **{DNS2}** for this display. If **{Network settings}** → **{Static IP}** is chosen.

### Digital Media Renderer - DMR

Receive multimedia files from the connected device by your network.

### Network name

In the multiple-display connection, you can rename each display for easy identification.

Use the on-screen keyboard or the remote control keypad to enter the name.

### Clear Internet memory

Clear all the cookies, bookmarks, history list and text used for auto fill.

## 6. USB device compatibility

### USB Video Subtitle Formats (for language subtitles, etc.)

Name	File extension	Format
MPEG-4 time-based text	.txt	XML
SAMI	.smi	HTML
SubRip	.srt	string-based
SubViewer	.sub	string-based
Micro DVD	.sub or .txt	string-based

### USB Multimedia Formats

File extension	Container	Video Codec	Resolution	Frame Rate (fps)	Bit Rate (Mbps)	Audio Codec
*.avi *.mkv	AVI MKV	DivX 3.11/4x/5.1/6.0	1920x1080	6~30	8	MP3/AC3/LPCM/ADPCM/DTS Core
		XviD	1920x1080	6~30	8	
		H.264 BP/MP/HP	1920x1080	6~30	25	
		MPEG4 SP/ASP	1920x1080	6~30	8	
		Motion JPEG	1920x1080	6~30	8	
*.asf	ASF	DivX 3.11/4x/5.1/6.0	1920x1080	6~30	8	MP3/AC3/LPCM/ADPCM/WMA
		XviD	1920x1080	6~30	8	
		H.264 BP/MP/HP	1920x1080	6~30	25	
		MPEG4 SP/ASP	1920x1080	6~30	8	
		Motion JPEG	1920x1080	6~30	8	
*.wmv	ASF	Window Media Video v9	1920x1080	6~30	25	WMA
*.mp4	MP4	H.264 BP/MP/HP	1920x1080	6~30	25	MP3/ADPCM/AAC
		MPEG4 SP/ASP	1920x1080	6~30	8	
		XVID	1920x1080	6~30	8	
*.3gp	3GPP	H.264 BP/MP/HP	1920x1080	6~30	25	ADPCM/AAC/ HE-AAC
		HEMPEG4SP/ASP	1920x1080	6~30	8	
*.vro *.vob	VRO VOB	MPEG1	352x288	24/25/30	30	AC3/MPEG/LPCM
		MPEG2	1920x1080	24/25/30	30	
*.mpg *.mpeg	PS	MPEG1	352x288	24/25/30	30	AC3/MPEG/LPCM/AAC
		MPEG2	1920x1080	24/25/30	30	
		H.264	1920x1080	6~30	25	
*.ts *.trp	TS	MPEG2	1920x1080	24/25/30	30	AC3/AAC/MP3/DD+/HE-AAC
		H.264	1920x1080	6~30	25	
		VC1	1920x1080	6~30	25	

#### NOTES:

- Sound or video may not work if the contents have a standard bit rate/frame rate above the compatible Frame/sec listed in the table above.
- Video content with a Bit rate or Frame rate larger than the rate specified in the table above can cause choppy video during playback.

## 7. Input Mode

### VGA Resolution:

Standard Resolution	Active Resolution		Refresh Rate	Pixel Rate	Aspect Ratio	Stand for Mode
	H Pixels	V Lines				
VGA	640	480	60 Hz	25.175 MHz	4:3	Video Graphic Array
			72 Hz	31.5 MHz		
			75 Hz	31.5 MHz		
WVGA	720	400	70 Hz	33.75 MHz	16:9	Wide Video Graphic Array
SVGA	800	600	60 Hz	40 MHz	4:3	Super VGA
			75 Hz	49.5 MHz		
XGA	1024	768	60 Hz	65 MHz	4:3	Extended Graphic Array
			75 Hz	78.75 MHz		
WXGA	1280	768	60 Hz	79.5 MHz	5:3	Wide XGA
WXGA	1280	800	60 Hz	79.5 MHz	16:10	Wide XGA
SXGA	1280	960	60 Hz	108 MHz	4:3	Super XGA
SXGA	1280	1024	60 Hz	108 MHz	5:4	Super XGA
WXGA	1360	768	60 Hz	85.5 MHz	16:9	Wide XGA
WXGA	1366	768	60 Hz	85.5 MHz	16:9	Wide XGA
UXGA	1600	1200	60 Hz	162 MHz	4:3	Ultra XGA
HD1080	1920	1080	60 Hz	148.5 MHz	16:9	HD1080

### SDTV Resolution:

Standard Resolution	Active Resolution		Refresh Rate	Pixel Rate	Aspect Ratio	Stand for Mode
	H Pixels	V Lines				
480i	720	480	29.97 Hz	13.5 MHz	4:3	Modified NTSC Standard
480p			59.94 Hz	27 MHz		
576i	720	480	25 Hz	13.5 MHz	4:3	Modified PAL Standard
576p			50 Hz	27 MHz		

### HDTV Resolution:

Standard Resolution	Active Resolution		Refresh Rate	Pixel Rate	Aspect Ratio	Stand for Mode
	H Pixels	V Lines				
720p	1280	720	50 Hz	74.25 MHz	16:9	Normally DVB Mode
			60 Hz			
1080i	1920	1080	25 Hz	74.25 MHz	16:9	Normally ATSC Mode
			30 Hz			
1080p	1920	1080	50 Hz	148.5 MHz	16:9	Normally ATSC Mode
			60 Hz			

- The PC text quality is optimum in HD 1080 mode (1920 x 1080, 60Hz).
- Your PC display screen might appear different depending on the manufacturer (and your particular version of Windows).
- Check your PC instruction book for information about connecting your PC to a display.
- If a vertical and horizontal frequency-select mode exists, select 60Hz (vertical) and 31.5KHz (horizontal). In some cases, abnormal signals (such as stripes) might appear on the screen when the PC power is turned off (or if the PC is disconnected). If so, press the [INPUT] button to enter the video mode. Also, make sure that the PC is connected.
- When horizontal synchronous signals seem irregular in RGB mode, check PC power saving mode or cable connections.
- The display settings table complies to the IBM/VESA standards, and based on the analog input.
- The DVI support mode is regarded as same to the PC support mode.
- The best timing for the vertical frequency to each mode is 60Hz.

## 8. Pixel Defect Policy

We strive to deliver the highest quality products and use some of the industry's most advanced manufacturing processes whilst practicing stringent quality control. However, pixel or sub-pixel defects on the PDP / TFT panels used in Plasma- & LCD- displays are sometimes unavoidable. No manufacturer can guarantee that all panels will be free from pixel defects, but Philips guarantees that any Plasma- & LCD- displays with an unacceptable number of defects will be repaired during the warranty period in line with your local guarantee conditions.

This notice explains the different types of pixel defects and defines the acceptable defect level for the LCD screen. In order to qualify for repair under warranty, the number of pixel defects must exceed a certain level as shown in the reference table. If the LCD screen is within specification a warranty exchange / claim back will be refused. Additionally, because some types or combinations of pixel defects are more noticeable than others, Philips sets even higher quality standards for those.

### 8.1. Pixels and Sub-Pixels

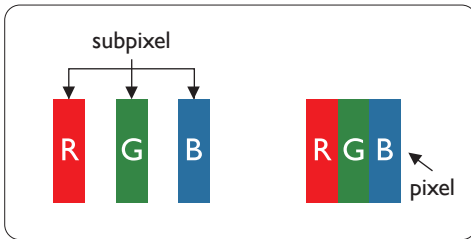

A pixel, or picture element, is composed of three sub-pixels in the primary colors of red, green and blue. Many pixels together form an image. When all sub-pixels of a pixel are lit, the three colored sub-pixels together appear as a single white pixel. When all are dark, the three colored sub-pixels together appear as a single black pixel. Other combinations of lit and dark sub-pixels appear as single pixels of other colors.

### 8.2. Types of Pixel Defects + Dot Definition

Pixel and sub-pixel defects appear on the screen in different ways. There are three categories of pixel defects and several types of sub-pixel defects within each category.

#### Dot definition = What is a defective “Dot”? :

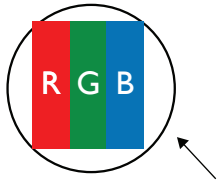

One or more defective, adjacent sub-pixel are defined as one “dot”. The no. of defective sub-pixels are not relevant to define a defective dot. This means that a defective dot can consist of one, two or three defective sub-pixels which can be dark or lit.



One dot = One Pixel; consists of three sub-pixels of Red, Green, and Blue.

### 8.3. Bright Dot Defects

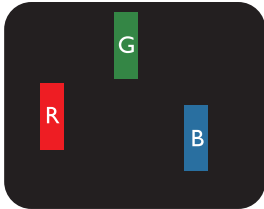
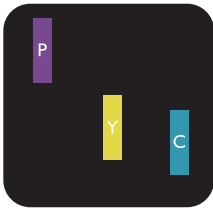
Bright dot defects appear as pixels or sub-pixels that are always lit or “on”. These are the examples of bright dot defects:

 <p>One lit red, green or blue sub pixel</p>	 <p>Two adjacent lit sub pixels:                  Red + Blue = Purple                  Red + Green = Yellow                  Green + Blue = Cyan (Light Blue)</p>	 <p>Three adjacent lit sub pixels (one white pixel)</p>
---	--	--

## 8.4. Dark Dot Defects

Black dot defects appear as pixels or sub-pixels that are always dark or "off". These are the examples of black dot defects:

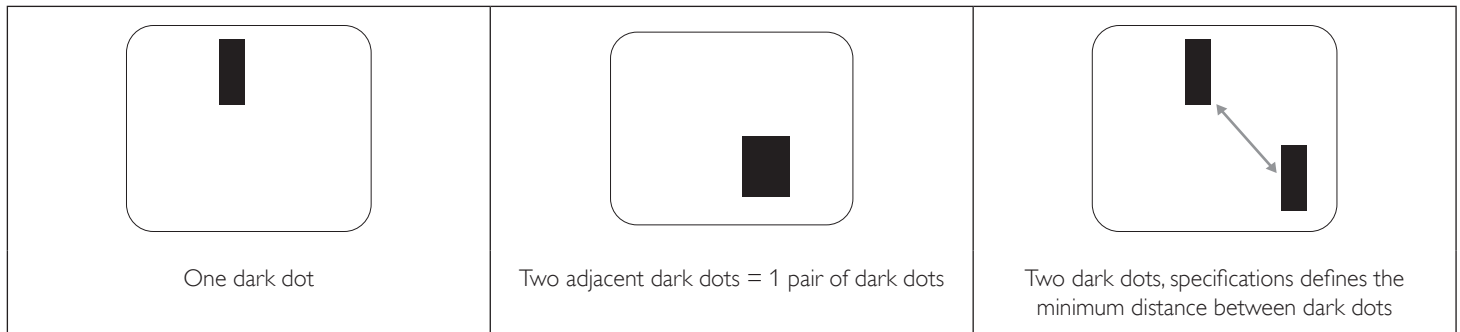

## 8.5. Proximity of Pixel Defects

Because pixel and sub-pixels defects of the same type that are nearby one another may be more noticeable, Philips also specifies tolerances for the proximity of pixel defects. In the table below you can find specifications about:

- Allowed amount of adjacent dark dots = (adjacent dark dots = 1 pair of dark dots)
- Minimum distance between dark dots
- Total no. of all defective dots

## 8.6. Pixel Defect Tolerances

In order to qualify for repair due to pixel defects during the warranty period, a PDP / TFT panel in a Philips Plasma / LCD- display must have pixel or sub-pixel defects exceeding the tolerances listed in the following table.

BRIGHT DOT EFFECT	ACCEPTABLE LEVEL
1 lit sub pixel	2
BLACK DOT EFFECT	ACCEPTABLE LEVEL
1 dark sub pixel	10
TOTAL DOT DEFECTS OF ALL TYPES	12

NOTE: \* 1 or 2 adjacent sub pixel defects = 1 dot defect

## 8.7. MURA

Dark spots or patches may occasionally appear on some liquid crystal display (LCD) panels. This is known within the industry as Mura, which is a Japanese term for "unevenness." It is used to describe an irregular pattern or area in which uneven screen uniformity appears under certain conditions. Mura is a result of the deterioration of the liquid crystal alignment layer and is most commonly caused by long-term operation under high ambient temperatures. It is an industry- wide phenomenon and Mura is not repairable. It is also not covered by our warranty terms.

Mura has been around since the introduction of LCD technology and with screens getting bigger and in operation 24/7, many displays are running in low light conditions. This all adds to the possibility of Mura affecting displays.

### HOW TO SPOT MURA

There are many symptoms of Mura and also multiple causes. Several of these are listed below:

- Impurities or foreign particles in the crystal matrix
- Uneven distribution of LCD matrix during manufacturing
- Non-uniform luminance distribution of the backlight
- Panel assembly induced stress
- Flaws within the LCD cells
- Thermal induced stress - high temperature operation over long periods of time

### HOW TO AVOID MURA

Although we can not guarantee the complete eradication of Mura every time, in general the appearance of Mura can be minimized by these methods:

- Lower the backlight brightness
- Use a screen saver
- Reduce the ambient temperature around the unit

## 9. Cleaning and Troubleshooting

### 9.1. Cleaning

#### Caution When Using the Display

- Do not bring your hands, face or objects close to the ventilation holes of the display. The top of the display is usually very hot due to the high temperature of exhaust air being released through the ventilation holes. Burns or personal injuries may occur if any body parts are brought too close. Placing any object near the top of the display could also result in heat related damage to the object as well as the display itself.
- Be sure to disconnect all cables before moving the display. Moving the display with its cables attached may damage the cables and thus cause fire or electric shock.
- Disconnect the power plug from the wall outlet as a safety precaution before carrying out any type of cleaning or maintenance procedure.

#### Front Panel Cleaning Instructions

- The front of the display has been specially treated. Wipe the surface gently using only a cleaning cloth or a soft, lint-free cloth.
- If the surface becomes dirty, soak a soft, lint-free cloth in a mild detergent solution. Wring the cloth to remove excess liquid. Wipe the surface of the display to remove dirt. Then use a dry cloth of the same type to dry.
- Do not scratch or hit the surface of the panel with fingers or hard objects of any kind.
- Do not use volatile substances such as insect sprays, solvents and thinners.

#### Cabinet Cleaning Instructions

- If the cabinet becomes dirty, wipe the cabinet with a soft, dry cloth.
- If the cabinet is extremely dirty, soak a lint-free cloth in a mild detergent solution. Wring the cloth to remove as much moisture as possible. Wipe the cabinet. Use another dry cloth to wipe over until the surface is dry.
- Do not allow any water or detergent to come into contact with the surface of the display. If water or moisture gets inside the unit, operating problems, electrical and shock hazards may result.
- Do not scratch or hit the cabinet with fingers or hard objects of any kind.
- Do not use volatile substances such as insect sprays, solvents and thinners on the cabinet.
- Do not place anything made from rubber or PVC near the cabinet for any extended periods of time.

## 9.2. Troubleshooting

Symptom	Possible Cause	Remedy
No picture is displayed	<ol style="list-style-type: none"> <li>1. The power cord is disconnected.</li> <li>2. The main power switch on the back of the display is not switched on.</li> <li>3. The selected input has no connection.</li> <li>4. The display is in standby mode.</li> </ol>	<ol style="list-style-type: none"> <li>1. Plug in the power cord.</li> <li>2. Make sure the power switch is switched on.</li> <li>3. Connect a signal connection to the display.</li> </ol>
Interference displayed on the display or audible noise is heard	Caused by surrounding electrical appliances or fluorescent lights.	Move the display to another location to see if the interference is reduced.
Color is abnormal	The signal cable is not connected properly.	Make sure that the signal cable is attached firmly to the back of the display.
Picture is distorted with abnormal patterns	<ol style="list-style-type: none"> <li>1. The signal cable is not connected properly.</li> <li>2. The input signal is beyond the capabilities of the display.</li> </ol>	<ol style="list-style-type: none"> <li>1. Make sure that the signal cable is attached firmly.</li> <li>2. Check the video signal source to see if it is beyond the range of the display. Please verify its specifications with this display's specification section.</li> </ol>
Display image doesn't fill up the full size of the screen	<ol style="list-style-type: none"> <li>1. The zoom mode is not set correctly.</li> <li>2. Scan Mode may be set incorrectly to underscan.</li> <li>3. If the image exceeds the screen size, Scan Mode may need to be set to Underscan.</li> </ol>	Use the Zoom mode or Custom zoom function in the Screen menu to fine tune display geometry and time frequency parameter.
Can hear sound, but no picture	Improperly connected source signal cable.	Make sure that both video inputs and sound inputs are correctly connected.
Can see picture but no sound is heard	<ol style="list-style-type: none"> <li>1. Improperly connected source signal cable.</li> <li>2. Volume is turned all the way down.</li> <li>3. {Mute} is turned on.</li> <li>4. No external speaker connected.</li> </ol>	<ol style="list-style-type: none"> <li>1. Make sure that both video inputs and sound inputs are correctly connected.</li> <li>2. Press <b>[+]</b> or <b>[-]</b> button to hear sound.</li> <li>3. Switch MUTE off by using the <b>[MUTE]</b> button.</li> <li>4. Connect external speakers and adjust the volume to a suitable level.</li> </ol>
Some picture elements do not light up	Some pixels of the display may not turn on.	This display is manufactured using an extremely high level of precision technology; however, sometimes some pixels of the display may not display. This is not a malfunction.
After-Images can still be seen on the display after the display is powered off. (Examples of still pictures include logos, video games, computer images, and images displayed in 4:3 normal mode)	A still picture is displayed for an over extended period of time	Do not allow a still image to be displayed for an extended period of time as this can cause a permanent after-image to remain on the display.



## 10. Technical Specifications

### Display:

Item	Specifications
Screen Size (Active Area)	31.5" (80 cm) LCD
Aspect Ratio	16:9
Number of pixels	1920 (H) × 1080 (V)
Pixel pitch	0.36375 (H) × 0.36375 (V) [mm]
Displayable colors	8bits(D),16.7Million colors
Brightness (typical)	400 cd/m <sup>2</sup>
Contrast ratio (typical)	1300:1
Viewing angle	178 degrees

### In/Out Terminals:

Item	Specifications
Speaker Output	Internal Speakers External Speakers
	10W (L) + 10W (R) [RMS]/8Ω 1 Way 1 Speaker System 82 dB/W/M/160 Hz ~ 13 KHz
Audio Output	Phone Jack × 1
	0.5V [rms] (Normal) / 2 Channel (L+R)
Audio Input	RCA Jack × 2 3.5 mm Stereo × 1
	0.5V [rms] (Normal) / 2 Channel (L+R)
RS232C	2.5mm Phone jack × 2
	RS232C in/RS232C out
RJ-45	RJ-45 Jack × 1 (8 pin)
	10/100 LAN Port
HDMI Input	HDMI Jack × 2 (Type A) (18 pin)
	Digital RGB:TMDS (Video + Audio) MAX: Video - 720p, 1080p, 1920 × 1080/60 Hz (WUXGA) Audio - 48 KHz/ 2 Channel (L+R) Supports LPCM only
DVI-D Input	DVI-D jack
	Digital RGB:TMDS (Video)
VGA Input	D-Sub Jack × 1 (15 pin)
	Analog RGB: 0.7V [p-p] (75Ω), H/CS/V: TTL (2.2kΩ), SOG: 1V [p-p] (75Ω) MAX: 720p, 1080p, 1920 × 1080/60 Hz (WUXGA)
DVI-I (DVI-D & VGA) Output	DVI-I Jack × 1 (29 pin)
	Digital RGB:TMDS (Video) Analog RGB: 0.7V [p-p] (75Ω), H/CS/V: TTL (2.2kΩ), SOG: 1V [p-p] (75Ω) MAX: 720p, 1080p, 1920 × 1080/60 Hz (WUXGA)
Component Input	BNC Jack × 3
	Y: 1V [p-p] (75Ω), Pb: 0.7V [p-p] (75Ω), Pr: 0.7V [p-p] (75Ω) MAX: 480i, 576i, 480p, 576p, 720p, 1080i, 1080p
Video Input	BNC × 1 (Share with Component_Y)
	Composite 1V [p-p] (75Ω)
Displayport in/out	Displayport Jack × 2 (20 pin)
	Digital RGB:TMDS (Video + Audio) MAX: Video - 720p, 1080p, 1920 × 1080/60 Hz (WUXGA) Audio - 48 KHz/ 2 Channel (L+R) Supports LPCM only

**General:**

Item	Specifications
Power Input	100 - 240V ~, 50 - 60Hz, 3.5A
Power Output	100 - 240V ~, 50 - 60Hz, 1.5A
Power Consumption (Max)	130 W
Power Consumption (typ.)	60 W
Power Consumption (Standby & Off)	<0.5W (RS232 in active)
Dimensions (With Stand) [W x H x D]	750.2 x 491.8 x 239.8 mm
Dimensions (Without Stand) [W x H x D]	750.2 x 444.6 x 69.0 mm
Weight (With Stand)	12.7 Kg
Weight (Without Stand)	11.4 Kg
Gross Weight (Without Stand)	14.9 Kg

**Environmental Condition:**

Item		Specifications
Temperature	Operational	0 ~ 40°C
	Storage	-20 ~ 60°C
Humidity	Operational	20 ~ 80% RH (No condensation)
	Storage	5 ~ 95% RH (No condensation)
Altitude	Operational	0 ~ 3,000 m
	Storage / Shipment	0 ~ 9,000 m

**Internal Speaker:**

Item	Specifications
Type	1 Way 1 Speaker
Input	10 W (RMS)
Impedance	8Ω
Output Sound Pressure	82 dB/W/M
Frequency Response	160 Hz ~ 13 KHz



2014 © Koninklijke Philips N.V. All rights reserved.

Philips and the Philips Shield Emblem are registered trademarks of Koninklijke Philips N.V. and are used under license from Koninklijke Philips N.V.

Specifications are subject to change without notice.