

# electriQ

## USER MANUAL



### **ANGLED GLASS AND STEEL DESIGNER CHIMNEY COOKER HOOD**

**eiQCHFGBSS60/ eiQCHFGBSS90**

Thank you for choosing electriQ  
Please read this user manual before using this  
product and keep it safe for future reference.  
Visit our page [www.electriQ.co.uk](http://www.electriQ.co.uk) for our entire product range

## **CONTENTS**

SAFETY	3
PRODUCT OVERVIEW	5
VENTING OPTIONS	6
INSTALLATION	7
FILTER OPTIONS	13
OPERATION	14
CLEANING AND MAINTENANCE	15
LIGHT REPLACEMENT	16
TROUBLESHOOTING	16
PRODUCT FICHE	17
SUPPORT	19

## **SAFETY PRECAUTIONS**











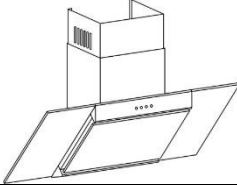
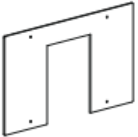

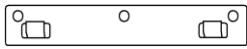
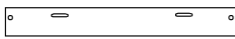

Whilst this product is compliant with all safety requirements, incorrect or inappropriate use can lead to both personal injury and potential damage to property. Please read the contents of this instruction booklet thoroughly before fitting or using this appliance.

- The cooker hood must be installed in accordance with the installation instructions and all measurements followed.
- All installation work must be carried out by a competent person or qualified electrician.
- The unit must be connected to an earthed power supply.
- If venting externally, make sure the ducting has no bends sharper than 90 degrees as this will reduce the efficiency of the cooker hood.
- The cooker hood is for domestic use only and is not designed for commercial use. It should only be used for the purpose it was intended – to extract vapours and cooking odours.
- Do not flambé or use an open flame under the cooker hood.
- Do not try to use the cooker hood without the grease filters or if the filters are excessively greasy. They should be cleaned regularly (see “Maintenance”) or replaced as necessary.
- The extraction fan must be level to avoid grease collection at one end, as this could cause a potential fire risk.
- Do not leave frying pans unattended during use because overheated fat or oils might catch fire.
- If the cooker hood is damaged, do not attempt to use it.
- If the supply cord is damaged, it must be replaced by the manufacturer, its service agent or a similarly qualified person in order to avoid a hazard.
- This appliance can be used by children aged from 8 years and above and persons with reduced physical, sensory or mental capabilities or lack of experience and knowledge if they have been given supervision or instruction concerning use of the appliance in a safe way and understand the hazards involved.
- Children shall not play with the appliance. Cleaning and user maintenance shall not be made by children without supervision.
- Children should be supervised to ensure that they do not play with the appliance. It is not a toy.

- The plug must be accessible after installation for isolation in case of an emergency – or an appropriate fused switch if the unit is hard-wired to the mains via a spur.
- The minimum distance between the surface of the hob and the lowest part of the hood should be at least 65cm. A distance of between 65cm and 75cm gives peak efficiency.
- The air must not be discharged into a flue that is used for exhausting fumes from appliances burning gas or other fuels.
- When the hood is vented externally and used with appliances which burn fuel (e.g. gas, oil, wood) the area must be sufficiently ventilated to ensure safe operation. Fresh air must be allowed to freely enter the room to prevent a partial vacuum.
- A partial vacuum can starve the heating appliance of oxygen, impairing combustion. It can also prevent toxic fumes from leaving the room, or can cause fumes to be sucked into the room from outside.
- Safe operation is only possible when the partial vacuum within the working area does not exceed 4 Pa (0.04 mbar). This can be achieved by ensuring air is able to enter the room from outside through a suitable sized opening which cannot be sealed during operation. A number of alternative solutions are available to ensure this. If in any doubt, professional advice should be sought.
- Regulations concerning the discharge of air have to be fulfilled.
- There is a potential fire risk if cleaning is not carried out in accordance with the instructions.
- Clean your appliance periodically by following the method given in the chapter MAINTENANCE
- If used in recirculation mode, the charcoal filters trap odours and must be replaced at least once a year depending on how frequently the cooker hood has been used.
- For safety reasons, please use only the same size of fixing or mounting screw, which are recommended in this instruction manual.
- Warning: Failure to install the screws or fixing device in accordance with these instructions may result in electrical hazards

**CAUTION: Accessible parts of the hood can become very hot during use with cooking appliances, whether in use or not, due to heat rising from the hob. Sufficient time should be allowed for the unit to cool before touching either the housing or the grease filters**

## PRODUCT OVERVIEW - PARTS SUPPLIED

Description	Illustration	Qty.
Cooker hood		1
glass		1
Outer chimney		1
Inner chimney		1
Wall bracket		1
Plate I		1
Plate II		1
Screw (4mm x 40mm)		7
Screw (4mm x 30mm)		2
Wall plug		9
Rubber cushion		4
Screw 4x25mm		4
Screw (4mm x 8mm)		4
Exhaust Pipe		1
cable tie		1
Adaptor		1
Air Flaps		2

## EXTERNAL VENTING

If you have an outlet to the outside, your cooker hood can be connected as shown in the diagram using any suitable extraction duct (enamel, aluminium, flexible pipe or inflammable material with an interior diameter of 150mm) can be used.

An adaptor is supplied to enable you to connect your hood to pre-existing 120mm diameter ducting.

If this is the chosen installation method consideration to the route of the vent pipe should be made prior to installation.

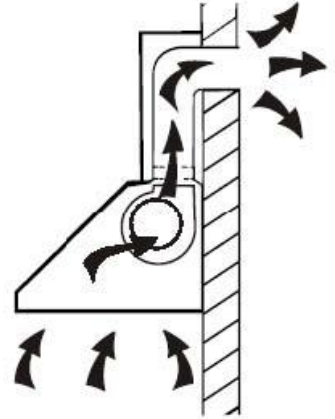

## RECIRCULATION

This cooker hood also supports the recirculation of air once it has passed through the filters. The filtered air is then expelled through the vent holes in the side of the chimney.

When setting the unit up in this configuration, carbon filters should also be used to remove odours from the air. Details of sourcing and fitting the filters can be found in the Carbon filter section.

When setting up for recirculation the installation instructions should be followed, but a vent pipe should not be attached, and instead the air can be routed back into the room through the top of the unit.

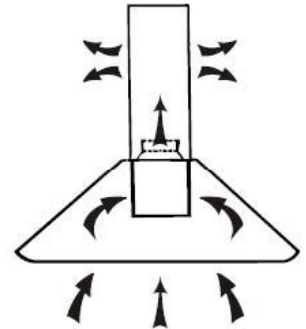

## UNPACKING YOUR APPLIANCE

- Please take great care when unpacking; a sharp blade should not be used to open the box, as it may go deep enough inside to damage components. Components damaged or marked by careless unpacking are not covered under the guarantee.
- Carefully unpack the contents and check against the section below (Parts) and the next section (Product overview).
- Packaging materials should be recycled in accordance with local regulations

## INSTALLATION

1. Before installation, ensure you have not connected the appliance to the mains supply.
2. The cooker hood should be placed at a distance of 65~75cm above the cooking plane for best effect.

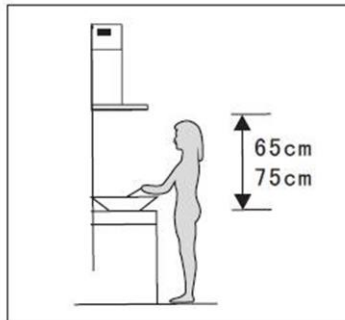

Pic 1

3. Insert the glass into the panel glove of the cooker hood, then use 4 screws (4 x 25mm), inserting them through the 4 x rubber cushions to fix the glass into the cooker hood (see diagrams).

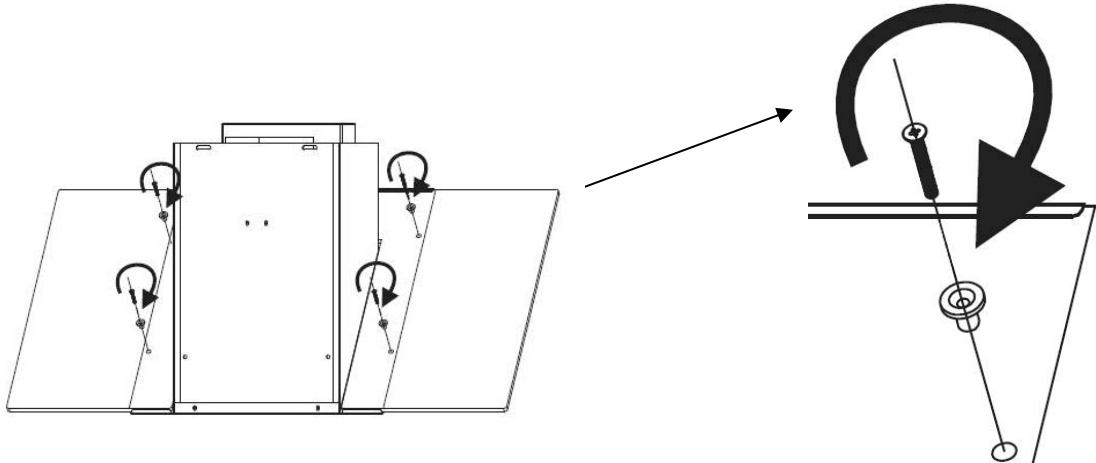
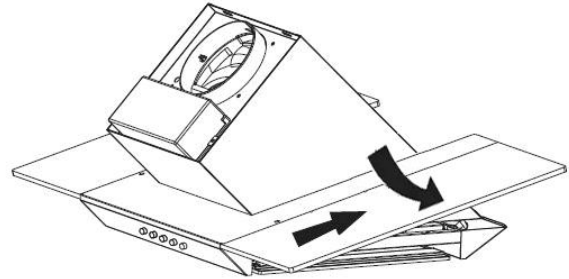

4. The 2 x air flaps should be installed at this stage, as access is easier before the unit is wall mounted. On the top of the Hood Unit itself, where the air outlet vent is located, the 2 x flaps should be carefully installed, bending very slightly so the lugs at each end locate into the holes, enabling flaps to pivot upwards when the unit is in operation, opening up the outlet fully for the air to pass through. Please note: the small spindles/lugs at each end of each flap locate into the **holes** on the housing, not the grooves above them:





5. Attach the exhaust pipe onto the outlet as shown below, and fix the pipe on the outlet by cable tie. The adaptor can be used at this stage, if you already have existing smaller diameter venting in place to connect.

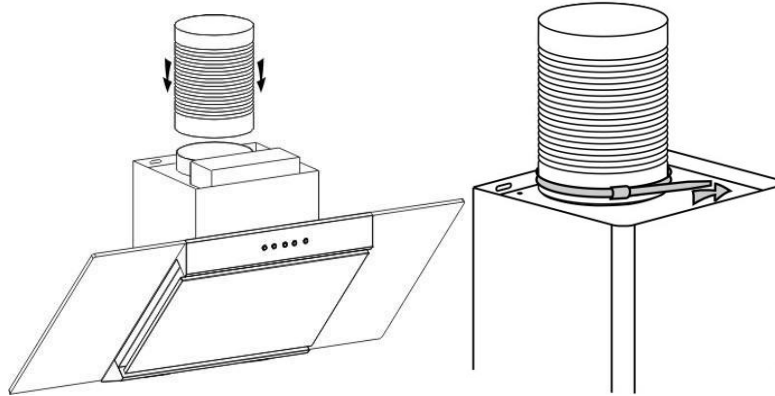

6. Drill 3 holes to accommodate the wall bracket. Screw and tighten the wall bracket onto the wall with the screws (4mm x 40 mm) and wall plugs provided.

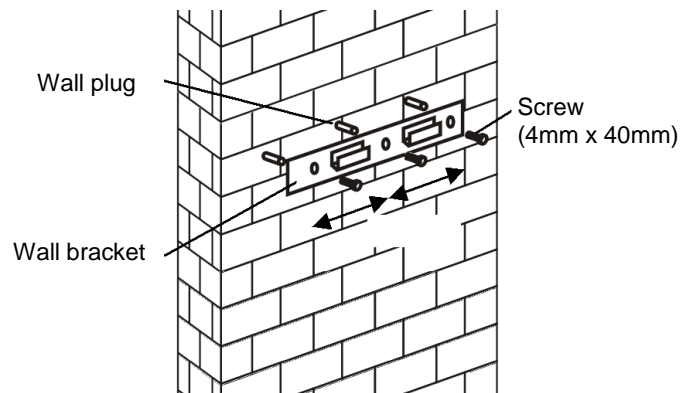

7. Hang the appliance onto the wall bracket. Also, fix the cooker hood on the wall by two 4x 30mm screws and wall plugs through the back of the cooker hood.

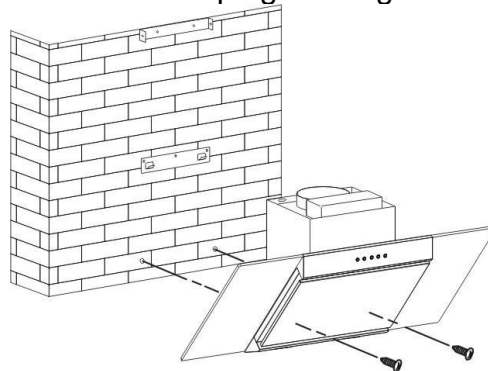

8. Put the inner chimney on the outer chimney. Install plate I on the chimney by two screws (4 mm x 8mm). Drill holes on the wall to accommodate plate I.

NOTE: Remember not to fix the screws (4 mm x 8mm) too tightly; 1mm loose is recommended, so that later height adjustment can be done more easily.

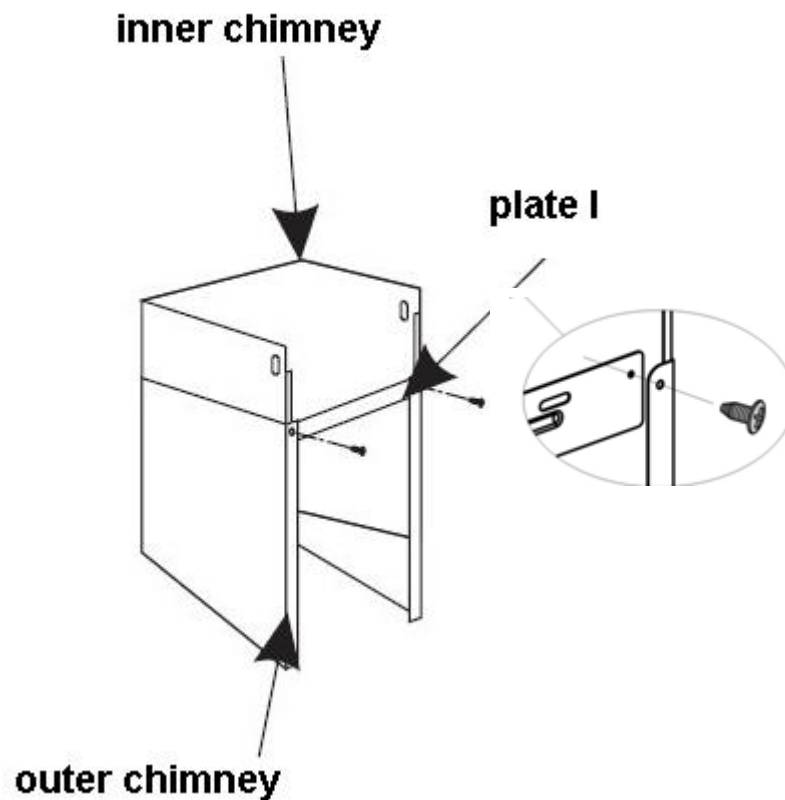
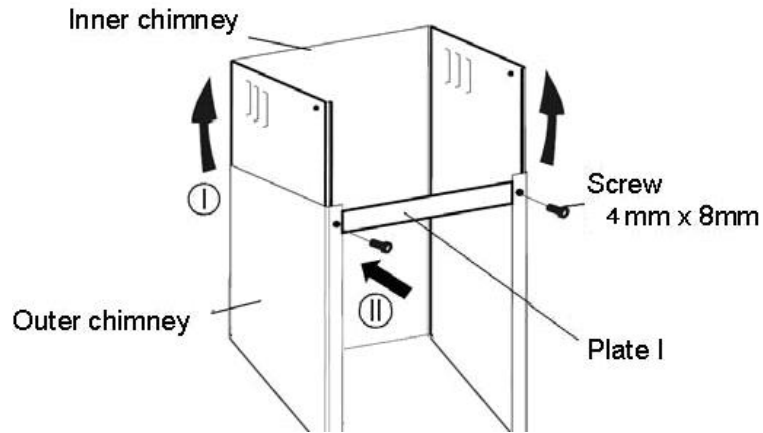

9. Drill 2 holes to accommodate plate II. Screw and tighten the plate II onto the wall with the screws (4mm x 40 mm) and wall plugs provided.

Note: Plate II is used to fix the chimney. The below diagram is for reference. Fixing the chimney to wall plate is done at the end of installation.

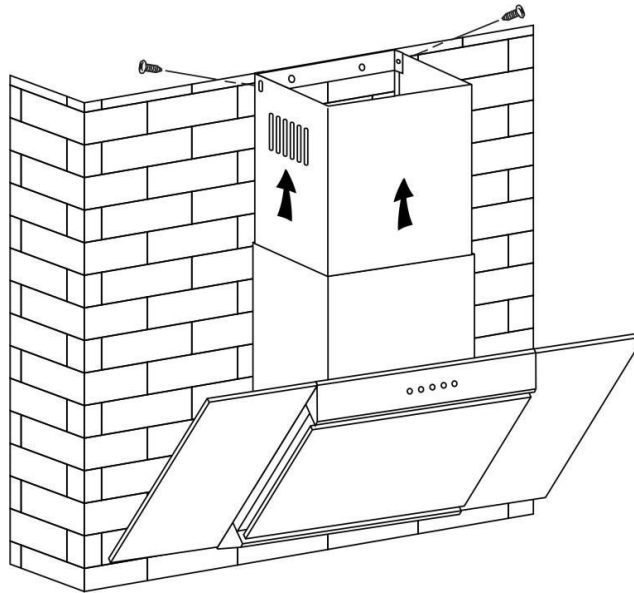
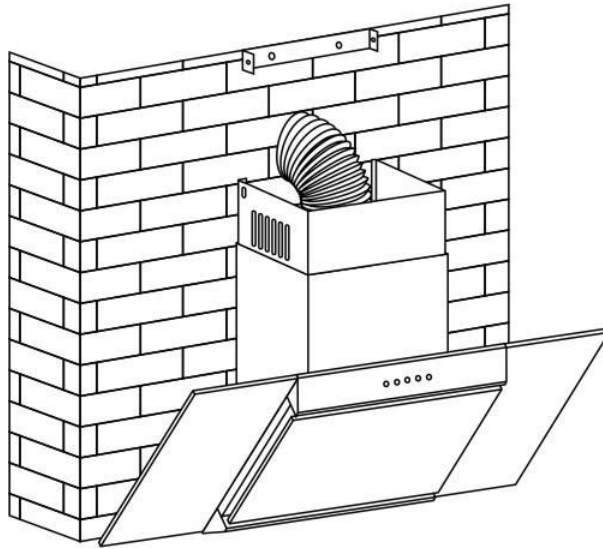

10. Put the installed chimneys on the cooker hood. Fix the Plate I to the wall by using 2 (4mm x 40 mm) screws and wall plugs. Pull out extensible pipe till it feeds through the hole on the wall.

Lift the inner chimney onto the plate II, fix the inner chimney to the plate II by using 2 screws (4mm x 8mm).

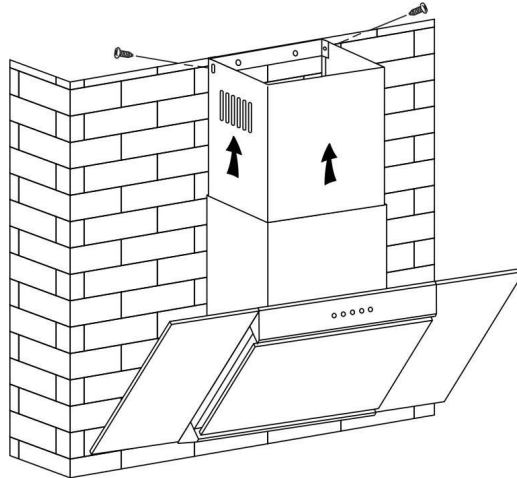

After installation, make sure that the extractor is level to avoid grease collection at one end.

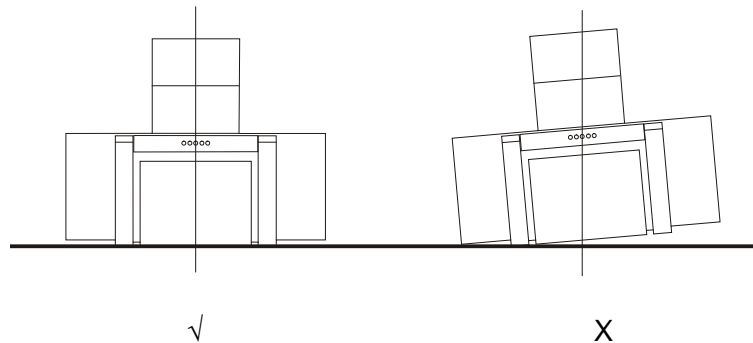

11. Before usage, read all the instructions and make sure that the voltage (V) and the frequency (Hz) indicated on the identification plate (found inside the cooker hood) and all the data inside the appliance are exactly the same as the voltage and frequency in your home. Then plug the power lead into the power socket (unless you are hard-wiring in to the mains) and start the cooker hood. .

## CARBON FILTER (OPTIONAL)

Activated carbon filters should be used to trap odours (optional – available from the same stockist you purchased the hood from) and must be used if the hood is not vented to the outside.

reference:

### eiQCF110 (Carbon Filter Pack of 2 – fits both 60cm and 90cm models)

In order to install the activated carbon filters, the aluminium filter should be removed first. Press the lock and pull it downward as below:

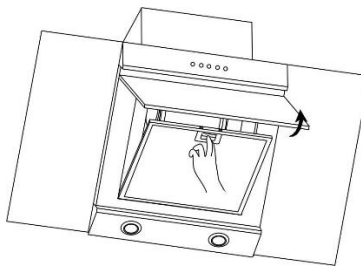

Put the activated carbon filter onto the end of the motor unit and turn it in anti-clockwise direction. Repeat the same on the other side (see below)

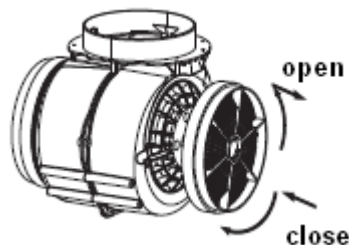

#### NOTE:





- Make sure the filter is securely locked. Otherwise, it could loosen and cause damage to unit.
- When the activated carbon filters are attached, the suction power will be lowered.
- The charcoal filter cannot be washed or recycled. It should be changed at three or six months according to the amount of use the hood receives.



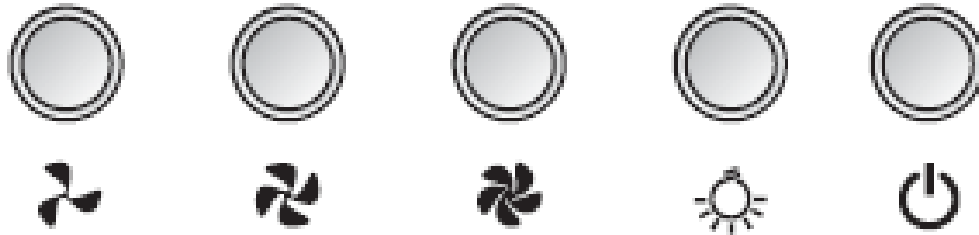



Replacements are available from the stockist from whom you purchased the hood:

### eiQCF110 (Carbon Filter Pack of 2 – fits both 60cm and 90cm models)

## OPERATION



There are five buttons:  (Low),  (Mid),  (High),  (Light),  (Power).

1. After connecting the hood, the indicator light will turn on and the hood will enter standby mode.
2. Power on: Press power button  once, and the power indicator light will be turned on, the hood will automatically begin at low speed. The low speed indicator light  will be on. Press the power button again to turn the unit off.
3. Press lamp button  once; lights will be turned on. The lamp indicator will turn off . Press the light button again to turn off the light.
4. Press the  (High) button to turn on the high-speed function. Press the  (Mid) button once, motor runs on middle speed. Press the  (low) button once, motor runs on low speed. The corresponding speed indicator will be lit while in use.

## **MAINTENANCE**

Before cleaning, switch the unit off and pull out the plug, or switch off at the relevant mains switch if the unit has been hard-wired in. Make sure the unit has no power being fed to it.

### **I. Regular Cleaning**

Use a soft cloth moistened with hand-warm mildly soapy water or household cleaning detergent. Never use metal pads, chemical, abrasive material or a stiff brush to clean the unit. Do not use a steam-cleaner to clean the hood; electrical components could be damaged or short-circuit as a result.

### **II. Monthly Cleaning for metallic anti-grease filter**

Clean the filter every month; an excessive build-up of grease can become a fire hazard. The filter collects grease, smoke and dust, so the filter directly affects the efficiency of the cooker hood. If it's not cleaned, the grease residue (potentially flammable) will saturate on the filter.

Remove the filter as shown in the Installation section. Clean it with a soft nylon brush in a mild solution of warm water and a small amount of washing up liquid. Washing up liquid alone should not be used. After cleaning, allow the filter to drain and then dry thoroughly.

Replacement grease filters are available from the same stockist from where you purchased the hood:

**60cm models: eiQAL52C160 x 1**

**90cm models: eiQAL52C190 x 1**

### **III. Replacement for Activated Carbon Filter**

These are only required in units that have been installed in recirculation mode (not vented to the outside). These filters trap odours and must be replaced at ideally every 3-6 months depending on how frequently the cooker hood has been used.

**eiQCF110 (Carbon Filter Pack of 2 – fits both 60cm and 90cm models)**

## LIGHT REPLACEMENT

**IMPORTANT:** The light fitting must be replaced by the manufacturer, its service agent or similarly qualified persons

LED lamp:

1. Use the correct light: 2 x 1.5W LED.
2. Carefully take out the lamp with a suitable tool.
3. Change the lamp.

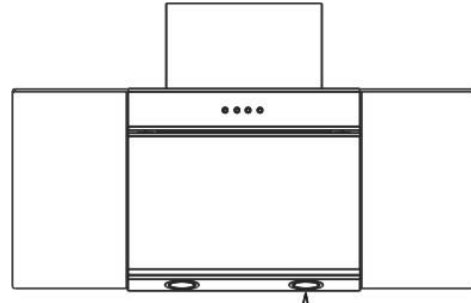

## TROUBLESHOOTING

Fault	Cause	Solution
Light on, but fan does not work	The fan blade is jammed.	Switch off the unit. Repair to be carried out by qualified service personnel only.
	The motor is damaged.	
Both light and fan do not work	Light blown	Replace the light with correct rating.
	Power cord loose	Plug in to the power supply again.
Excessive Vibration	The fan blade is damaged.	Switch off the unit. Repair to be carried out by qualified service personnel only.
	The fan motor is not fixed tightly.	Switch off the unit. Repair to be carried out by qualified service personnel only.
	The unit is not hung properly on the bracket.	Take down the unit and check whether the bracket is in proper location.
Suction performance not good	1 Grease filters clogged 2 Distance between the unit and the cooking plane too great.	1 Clean or replace grease filters. 2. Readjust the distance to between 70cm and 80cm.



## PRODUCT FICHE

	Symbol	Value	Unit
Model identification		eiQCHFGBSS60 eiQCHFGBSS90	
Annual Energy Consumption	$AEC_{hood}$	81.6	kWh/a
Time increase factor	f	1.4	
Fluid Dynamic Efficiency	$FDE_{hood}$	15.9	
Fluid Dynamic Efficiency class		Class D	
Energy Efficiency Index	$EEl_{hood}$	80.0	
Energy Efficiency class		Class C	
Measured airflow rate at the best efficiency	$Q_{BEP}$	274.8	m <sup>3</sup> /h
Measured air pressure at best efficiency point	$P_{BEP}$	318	Pa
Maximum airflow	$Q_{max}$	581.8	m <sup>3</sup> /h
Air flow at working point (highest setting)		553.9	m <sup>3</sup> /h
Air flow at working point (lowest setting)		398.8	m <sup>3</sup> /h
Measured electric power input at best efficiency point	$W_{BEP}$	152.6	W
Nominal power of the lighting system	$W_L$	4.1	W
Average illumination of the lighting system on the cooking surface	$E_{middle}$	82(600MM); 76(900MM);	lux
Lighting efficiency	$LE_{hood}$	20.0(600MM); 18.5(900MM);	lux/W
Lighting efficiency class		Class C	
Grease Filtering Efficiency	$GFE_{hood}$	64.7	

Grease Filtering Efficiency (GFE hood) class		Class E	
Measured power consumption on standby mode	$P_s$	0.53-	W
Measured power consumption on off mode	$P_o$	0.38	W
Sound power level (Highest setting)	$L_{WA}$	69	dB
Sound power level (Lowest setting)	$L_{WA}$	65	dB

The following shows how to reduce total environmental impact (e.g. energy use) of the cooking process).

- (1) Install the cooker hood in a proper place where there is efficient ventilation.
- (2) Clean the cooker hood regularly so as not to block the airway.
- (3) Remember to switch off the cooker hood light after cooking.
- (4) Remember to switch off the cooker hood after cooking.

## INFORMATION FOR DISMANTLING

Do not dismantle the appliance in a way which is not shown in the user manual. The appliance could not be dismantled by user. At the end of life, the appliance should not be disposed of with household waste. Check with you Local Authority or retainer for recycling advice.

## electriQ UK SUPPORT

[www.electriQ.co.uk/support](http://www.electriQ.co.uk/support)

Call: 03303903061

Office hours: 9AM - 5PM Monday to Friday

[www.electriQ.co.uk](http://www.electriQ.co.uk)

Unit J6, Lowfields Business Park  
Lowfields Way, Elland  
West Yorkshire, HX5 9DA



Recycling facilities are now available for all customers at which you can deposit your old electrical products. Customers will be able to take any old electrical equipment to participating sites run by their local councils. Please remember that this equipment will be further handled during the recycling process, so please be considerate when depositing your equipment. Please contact the local council for details of your local household waste recycling centres.