

# INSTALLATION AND USER MANUAL



## DC INVERTER AIR TO WATER HEAT PUMP

### SUPPLIER MODEL

SUPERHEAT-MHP7  
SUPERHEAT-MHP10  
SUPERHEAT-MHP12  
SUPERHEAT-MHP19

### MANUFACTURER MODEL

PAVH-06V1FXC  
PAVH-09V1FXC  
PAVH-12V1FXC  
PAVH-15V1FXC



**FOR OUTDOOR  
INSTALLATION ONLY**

# BOILER UPGRADE SCHEME (ENGLAND AND WALES)

The Boiler Upgrade Scheme is open to people in England and Wales and can provide a grant to cover part of the cost of replacing a fossil fuel heating system with a heat pump, when installed by an MCS certified installer.

## **You're eligible for a grant if all the following are true:**

- Own the property you're applying for (including if it's a business, a second home, or a property you rent out to tenants)
- The Property has a valid Energy Performance Certificate (EPC) with no outstanding recommendations for loft or cavity wall insulation.
- Have installed (or plan to install) your new heating system on or after 1 April 2022
- Be replacing fossil fuel heating systems (such as oil, gas or electric)

You're still eligible if you've already had funding to make your property more energy efficient, for example by insulating it.

## **You cannot get a grant for:**

- Most newly built properties.
- Social housing.
- A property that's already been given government funding or support for a heat pump or biomass boiler.

## **How to apply:**

- Contact suitable MCS certified installers to get quotes for the work.
- Confirm you're eligible (your installer can help advise).
- Agree a quote with your chosen installer.

Details correct at the time of writing (November 2023). We advise you check <https://www.gov.uk/apply-boiler-upgrade-scheme/check-if-youre-eligible> to check for any published changes to the scheme.

## **FINDING AN MCS CERTIFIED INSTALLER**

MCS manages a register of certified contractors for a range of technologies. You can find a local certified engineer using their search tool found at:

<https://mcs-certified.com/find-an-installer/>

# CONTENTS

SAFETY INSTRUCTIONS	3
HOW TO CHOOSE A SUITABLE HEAT PUMP	6
KEY FEATURES	7
PRODUCT OVERVIEW	7
PRODUCT DIMENSIONS	8
PARTS SUPPLIED	9
PLANNING YOUR INSTALLATION	10
SYSTEM DIAGRAMS	11
INSTALLATION GUIDE	12
POSITIONING THE HEAT PUMP	13
SECURING THE HEAT PUMP	14
CONNECTING THE WATER LOOP	15
ELECTRICAL CONNECTION	16
BEFORE FIRST OPERATION	17
INSPECTION	17
TRIAL RUN	17
OPERATION	18
WIFI SETUP	27
WIFI OPERATION	29
CLEANING AND MAINTENANCE	30
FAULT CODES	31
TROUBLESHOOTING	36
CIRCUIT DIAGRAMS	37
INSTALLER PARAMETERS	39
WATER QUALITY REQUIREMENTS	41
TECHNICAL DATA	42
SUPPORT	43

# SAFETY INSTRUCTIONS

Thank you for purchasing this heat pump which is produced following strict design and manufacturing standards to provide a high quality, reliable and versatile product. This manual includes all the necessary information about installation, debugging, discharging and maintenance. Please read this manual carefully before installation or use.

The manufacture of this product will not be held responsible for injury or damage resulting from improper installation, debugging, or maintenance which is not in line with this manual. The unit must be installed by qualified personnel.

It is vital that the instructions are adhered to at all times. The unit can only be opened or repaired by a qualified installer or an authorised dealer. Maintenance must be carried out according to the recommended time and frequency, as stated in this manual. Failure to comply with these recommendations will invalidate the warranty.

## IMPORTANT!

- To prevent the unit from causing harm or damage, please read this manual carefully and understand the following information correctly.
- Rating: This unit must be only connected to a 220-240 V / 50 Hz earthed supply.
- The circuit the appliance is connected to must be protected by a suitably rated RCD.
- The heat pump must be installed by qualified personnel, to avoid improper installation which can lead to water leakage, electrical shock or fire.
- Installation must be in accordance with regulations of the country where the unit is used.
- If you are in any doubt about the suitability of your electrical supply have it checked and, if necessary, modified by a qualified electrician.
- This heat pump has been tested and is safe to use. However, as with any electrical appliance - use it with care.
- Disconnect the power from the appliance before dismantling, assembling or cleaning.
- Even after disconnecting the power, energy may still be stored

in components, and so care should be taken to ensure the unit is safe to work on.

- If the appliance malfunctions, or if there is a strange smell, the unit should be turned off, and the power disconnected. Continued use may cause electrical short or fire.
- Avoid touching any moving parts within the appliance.
- Never insert fingers, pencils or any other objects through the guard.
- This appliance is not intended for use by persons (including children) with reduced physical, sensory or mental capabilities. It is also not intended for use by those with a lack of experience and knowledge, unless they have been given supervision or instruction concerning the use of the appliance by a person responsible for their safety.
- Do not leave children unsupervised with this appliance.
- Do not clean the unit by spraying it or immersing it in water.
- Maintenance must be carried out according to the recommended frequency given within this manual.
- Only genuine spare parts can be used. The use of parts or accessories not approved by the manufacturer will invalidate the warranty.
- This appliance is designed to be hardwired, and must be connected to a suitable all pole outdoor isolator switch, which must be installed in an accessible place close to the heat pump.
- Ensure the appliance is suitably secured in its final position to prevent the risk of tipping.
- The unit should be inspected monthly to ensure the mounting is secure.
- Never operate this appliance if the power cord is damaged. Ensure the power cord is not stretched or exposed to sharp objects/edges.
- A damaged supply cord should be replaced by the manufacturer or a qualified electrician in order to avoid a hazard.
- Any service other than regular cleaning should be performed by a qualified engineer. Failure to comply could result in a voided warranty.
- Do not use the appliance for any purpose other than its intended use.
- The heat pump unit must always be stored and transported upright, otherwise irreparable damage

may be caused to the compressor; if in doubt we suggest waiting at least 24 hours before starting the unit.

- Avoid restarting the heat pump unless 3 minutes have passed since being turned off. This prevents damage to the compressor.
- Install the unit on a dry and stable surface.
- Do not use the product and contact the retailer for advice, if damage has occurred to the unit which may have compromised the refrigerant system.
- The refrigerant system should not be perforated or punctured.
- Do not use means to accelerate the defrosting process or to clean, other than those recommended by the manufacturer.
- The appliance shall be stored in a room without continuously operating ignition sources (For example: Open flames, an operating gas appliance or electric heater.)
- Be aware that refrigerants may be odourless.
- Before gaining access to the terminals, all supply circuits must be disconnected.
- Any procedures which may affect the safety of the product must be conducted by a competent person after reading the service manual available from the manufacturer.
- Children should be supervised to ensure that they do not play with the appliance.
- The unit CANNOT be installed near flammable gas. Once there is any leakage of the gas fire can occur.
- The heat pump located inside the unit is equipped with an over-load protection system. It does not allow for the unit to start for at least 3 minutes from a previous power cut.
- DO NOT touch the heat exchanger of the heat pump with fingers or other objects.
- Decommissioning and/or moving the appliance must be conducted by a suitably qualified person. Failure to adhere to this could lead to water leakage, electrical shock, injury or fire.
- This appliance is designed for outdoor installation only. It should not be stored in a room with potential ignition sources (e.g. open flames, operating gas appliance or electric heater)

# HOW TO CHOOSE A SUITABLE HEAT PUMP

## HEATING REQUIREMENTS

The heating requirements for your home should be calculated, both in terms of room heating/cooling and the demand for hot water. When calculating this, there are many factors to consider including:

- Local climate conditions.
- Energy performance of the property.
- Construction features such as number of windows.

From the above, a professional will be able to calculate the heating capacity required per square meter, and in turn the total heating capacity required from the heat pump.

Once it is understood what capacity is required, the features of individual models should be compared to choose the one which best meets the requirements. This heat pump is suitable for operating at ambient temperatures between  $-25^{\circ}\text{C}$  and  $43^{\circ}\text{C}$ , although performance will be affected depending on the ambient temperature.

This heat pump also utilises inverter technology, allowing the heat output to be adjusted dependant on demand, to help ensure that the correct balance of performance and efficiency is achieved.

For larger properties such as offices, hotels and commercial spaces, it may be beneficial to zone the areas, with a separate heat pump covering different areas of the property.

# KEY FEATURES

- **Wired Controller** - Includes a wired controller allowing adjustment of the running parameters.
- **Flexible installation** - The unit has smart structure with a compact body, just simple outdoor installation is needed.
- **Quiet Running** - High quality and efficient compressor water pump and fan are used in conjunction with insulation to ensure quiet operation.
- **Highly Efficient** - The heat pump unit uses a specially designed heat exchanger to enhance the efficiency.
- **Low Temperature Operation** - This heat pump is designed to function in working conditions down to -25°C for heating.

# PRODUCT OVERVIEW

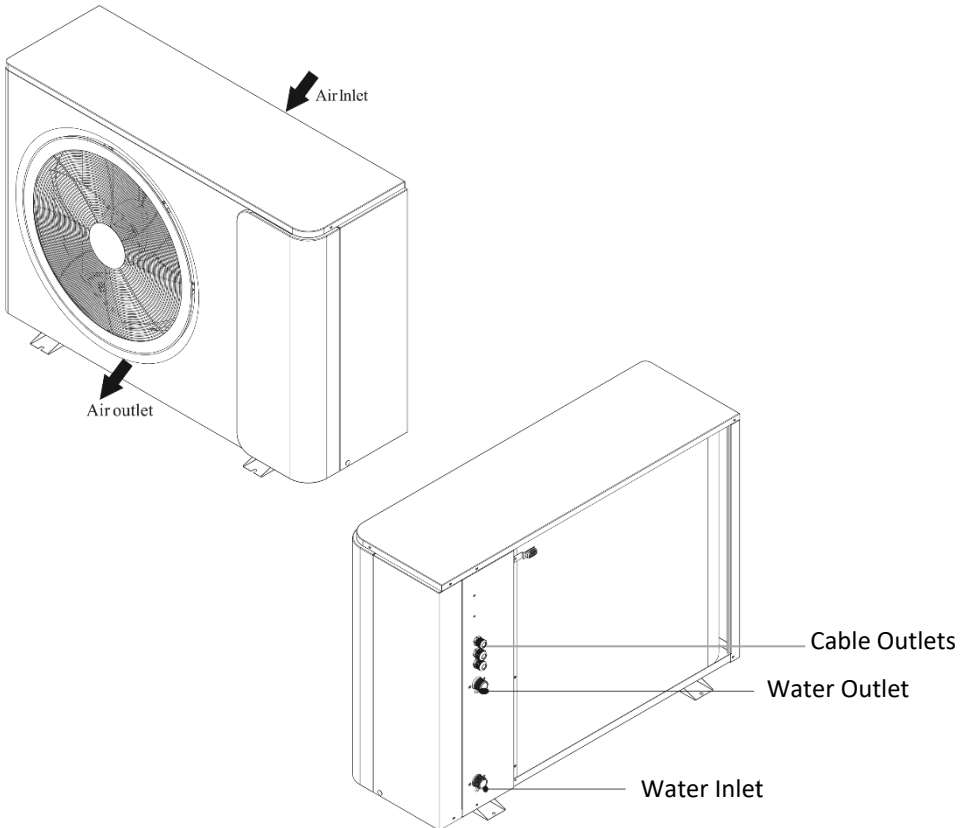



# PRODUCT DIMENSIONS

## SUPERHEAT-MPH7

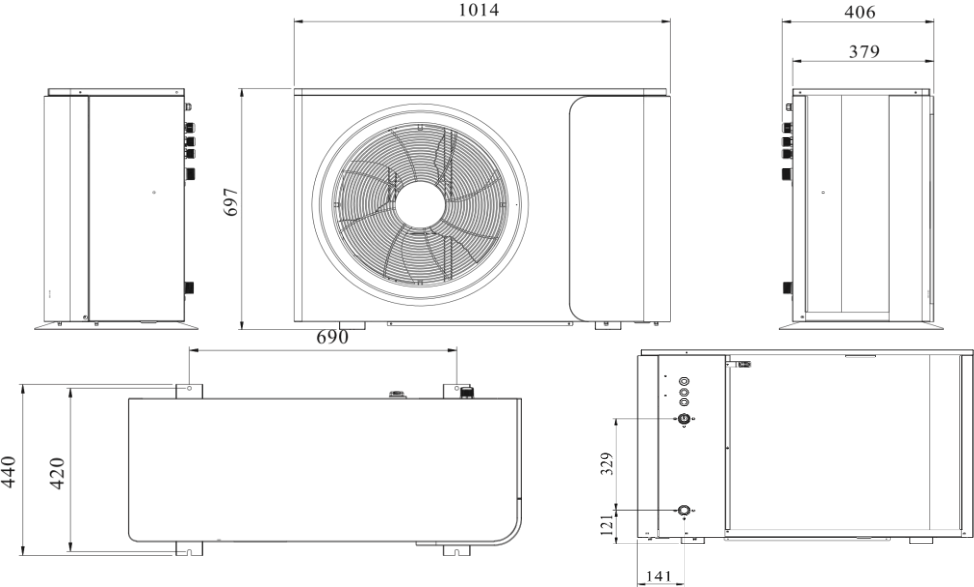



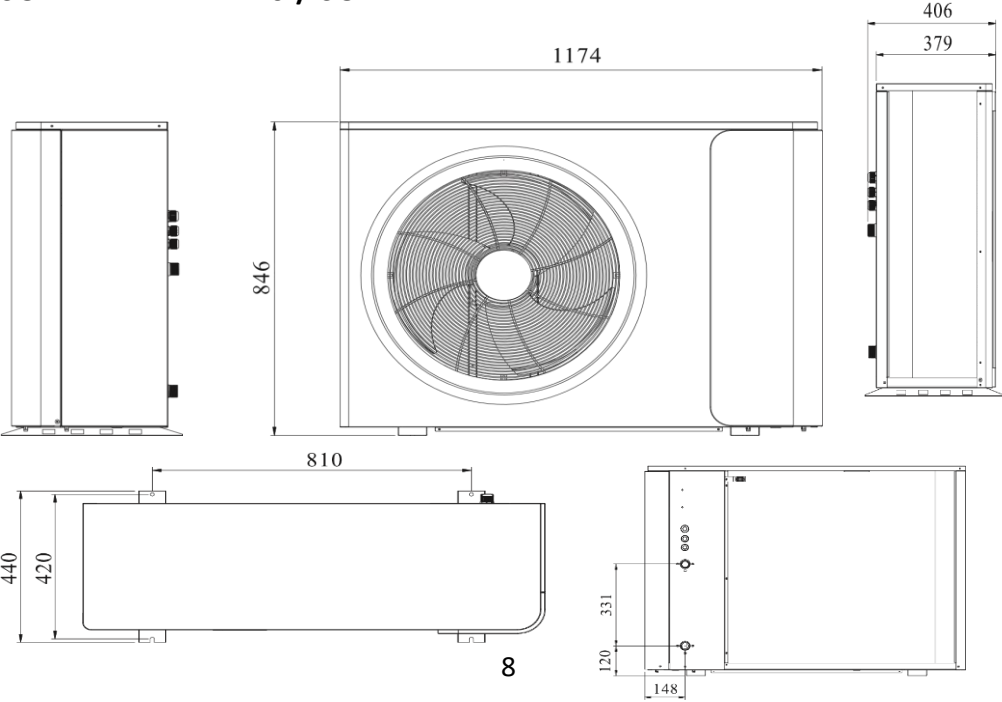

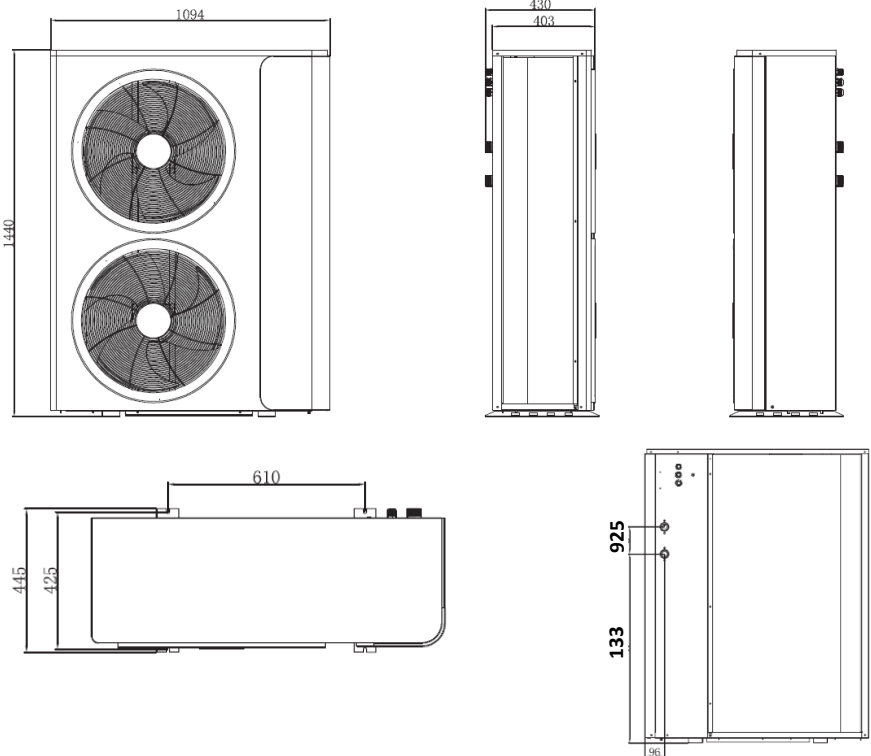

## SUPERHEAT-MPH10 / SUPERHEAT-MPH12



# SUPERHEAT-MPH19



## PARTS SUPPLIED

		
<p>Heat pump Unit</p>	<p>Wired Controller</p>	<p>Screws for Wired Controller x 2</p>
		
<p>10m Sensor Cable</p>	<p>10m Controller Cable</p>	<p>Bolts for Wired Controller x 2</p>

# PLANNING YOUR INSTALLATION

This Monobloc heat pump can be set up to provide heating, cooling and domestic hot water. Floor heating loops and radiators can be used for heating, and fan coil units can be connected to provide both cooling and heating. Domestic hot water is provided from a separate domestic hot water tank (DHW tank) connected to the heat pump.

It is important that the system is fully planned before installation, and that you are sure you have all the required parts to complete the system.

The system comprises of a DHW tank providing hot water to the premises and a Buffer tank (although separate, these can be integrated into a single unit), providing heat to radiators fan coils and underfloor heating. The engineer installing the unit would need to connect the heat pump to the system, which in addition to the tanks would usually require 2 water pumps (for water circulation in the heating/cooling system, and hot water), safety valve, water charge valve and a hot water valve, as well as other associated equipment. You would also need to consider if further temperature sensors are required, depending on the requirements and design of the system. See the system diagrams for further information.

Temperature sensors should be added to the tanks. Additional electric heaters and sensors can be installed in either tank, and its control signal can be provided by the heat pump.

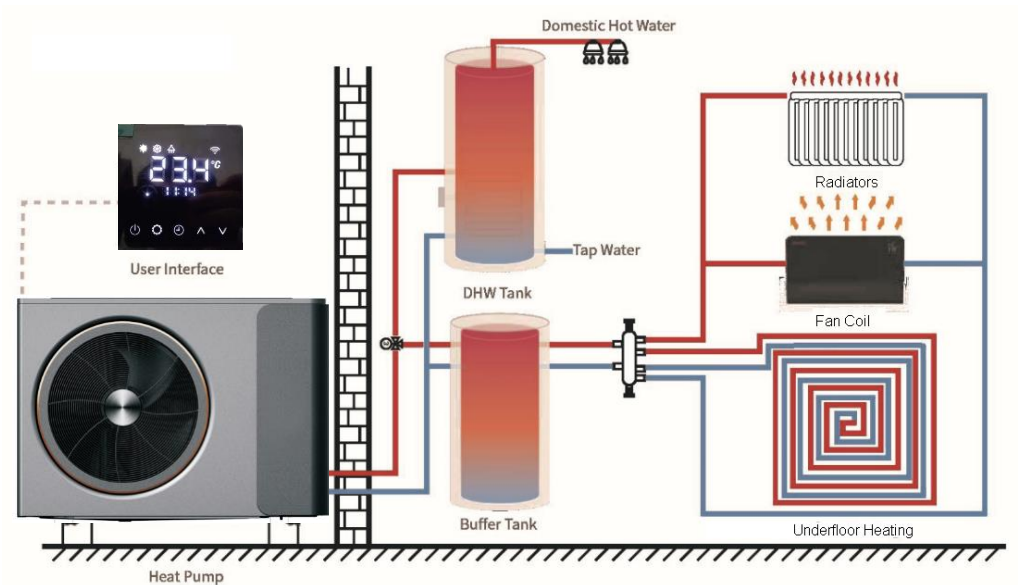

# SYSTEM DIAGRAMS

Each installation is different. It is important that the system is designed considering the needs of the user and premises where the appliance is installed. The following two are examples of best practice based on the most common application.

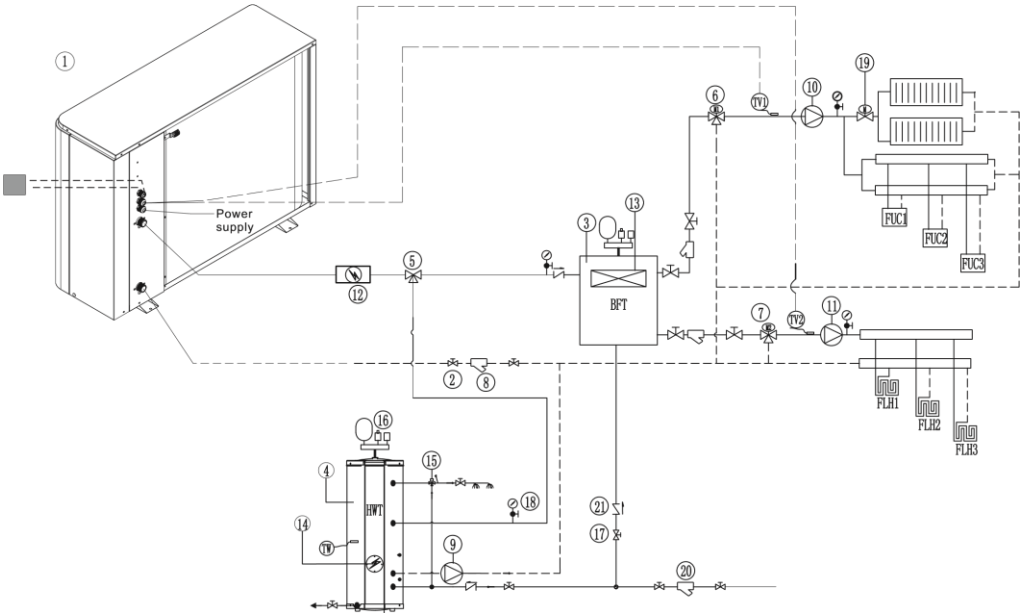

1	Monobloc unit	13	HBH-Heating Back-up Heater
2	Water two way valve	14	HWTBH-Hot Water Tank Back-up Heater
3	Buffer tank (For Heating Circuit)	15	Sanitary hot water mixture valve
4	Sanitary hot water storage tank	16	T/P valve
5	Motorized 3-way valve	17	Ball valve
6	Mixture valve 1 (0~10V)	18	Pressure meter
7	Mixture valve 2 (0~10V)	19	Motorized 2-way valve
8	Water way filter	20	Filter
9	Sanitary hot water circulation pump (Optional)	21	One-way valve
10	Circulation pump for system 1 (Optional)	TW	Hot water temperature sensor
11	Circulation pump for system 2 (Optional)	Tv1	Water temp. sensor after mixture valve 1
12	AH-Auxiliary heater (Optional)	Tv2	Water temp. sensor after mixture valve 2

# INSTALLATION GUIDE

## SAFETY WARNINGS

- This installation manual is intended for use by individuals possessing adequate backgrounds and qualifications.
- This appliance is designed for installation by an MCS certified engineer.
- Any attempt to install or repair the appliance may result in personal injury and/or property damage.
- The manufacturer, importer and retailer cannot be held responsible for the interpretation of this information, nor can it assume any liability in connection with its use.
- The units are designed for permanent installation.
- The equipment is designed for domestic or office use and we are not making any endorsements for its use in industrial or maritime environments.
- Do not place near sources of heat, vapours, industrial machine oil or other flammable gases.
- High frequency waves generated by radio equipment, welders and medical equipment will interfere with the normal operation of the unit.
- Install this device only when it complies with local/national legislation, ordinances and standards.
- Check the mains voltage and frequency. This unit is only suitable for an earthed electrical supply, connection voltage 220-240 V / 50 Hz.
- The information, specifications and parameter are subject to change due to technical modifications or improvement without any prior notice. The accurate specifications are presented on the rating label found on the appliance.
- Please read this installation manual completely before installing the product.
- When the power cord is damaged, replacement work shall be performed by authorised personnel only.
- Installation work must be performed in accordance with all European, national and / or local directives and standards and must be conducted by authorised personnel only.
- Always make sure to wear the correct personal safety protections such as protective eyewear, gloves, ear protection etc.

## POSITIONING THE HEAT PUMP

- A convenient position, dry and well ventilated, outside of direct sunlight or strong winds, which is not on flood line and where noise and airflow does not cause interference or inconvenience.
- Select a location where there are no obstructions to the inlet and outlet vents.
- The location should be able to withstand the full weight and vibration of the outdoor unit and permit safe installation.
- Make sure that there is easy access for maintenance.
- Select a place where it is out of reach of children.
- Do not block utilities access or fire escapes.
- The external unit must be lifted and put in place by two people or by specialised equipment.
- There must be water channel around the heat pump to drain the condensing water.

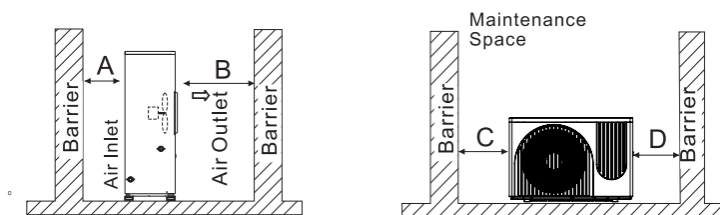

The picture shows the location of horizontal air outlet unit.

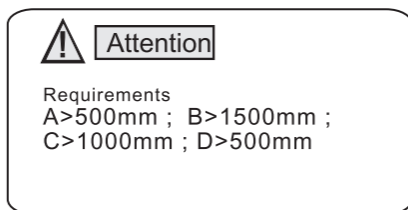

The minimum ventilation distance in diagram 1.

### NOTES:

- Only use the correct power supply voltage making sure the correct sized power cables are used
- The appliance shall be installed in accordance with standard wiring regulations by qualified personnel.
- Only replace fuses according to their printed rating or corresponding pcb boards.
- The circuit must be RCD protected, and an all-pole disconnection device must be installed in an accessible place close to the heat pump

## SECURING THE HEAT PUMP IN POSITION

The heat pump should be secured using expansion bolts (not included), onto a concrete base or a suitable steel wall mount (not included). When installing it is advisable to attach rubber dampening feet (not supplied) to reduce vibrations between the unit and its mounting points. Care should be taken to ensure that the product is horizontal to prevent issues with water drainage.

If the unit needs to be raised to a height during installation, it should be secured using an 8-meter cable. There must be soft material like padding between the cable and the unit to prevent damage to the heat pump cabinet during the lift

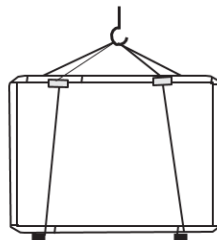

## INSULATION

All pipes running hot water should be well insulated. The insulation must be tied up tightly without gap (But please don't wrap up the check valve for future maintenance).

Please ensure enough water pressure to send the water to the required height. If the water pressure is not enough to maintain proper water flow rate for the system, please add a water pump to increase the pumping head.

## CONTROLLING YOUR HEATING

If the unit is in a system which also includes room heating (using a buffer tank), this manual only covers the installation and connection to the water tanks. A recirculating water pump should be installed on the system, with a suitable thermostatic controller, which will activate the pump when heating is required.

The heat pump in turn will monitor the temperature of the buffer tank (Sensors (not supplied) must be installed, and when the temperature within the tank drops, the heat pump will then apply heat to the buffer tank.

## CONNECTING THE WATER LOOP

The heat pump includes 1-inch (external diameter) inlet and outlet connections for attaching to the water loop, this can be connected to either metal or plastic pipe.

- Try to reduce the resistance to waterflow within the pipework, by limiting lengths and bends as far as practical, as this may affect performance.
- As part of the system design, the pipe diameter should be considered, as using 1.25" diameter pipework for the loop, may increase performance.
- Given the variety of pipework which may be used for the installation, it is not possible for pipe connectors / adaptors to be provided for attaching the water loop, and so it is the installers responsibility to ensure that a suitable watertight connection is made to the appliance.
- The pipework must be free from blockages, restrictions and dirt.
- A water leakage test must be conducted to ensure the system is watertight prior to installing the insulation on the pipework. This test should be conducted before the pipework is connected to the heat pump.
- An expansion tank must be installed at the top point of the water loop.
- The water level in the tank must be at least 0.5 meter higher than the top point of the water loop.
- The flow switch is integrated within the heat pump, the operation of this should be tested before use.
- Care should be taken to prevent air locks within the water pipe. An air vent should be installed at the top point of the water loop to allow removal of any air within the system.
- There must be thermometer and pressure meter at the water inlet and outlet for easy inspection during operation.
- As the water loop will be exposed to sub zero temperatures, Ethelene glycol should be used to lower the freezing point. We would suggest a solution of around 30-40% Ethelene glycol as suitable for the UK climate.

As the water temperature can reach 75°C, when selecting suitable pipework, the installer must ensure it is suitable to withstand the temperatures it may be exposed to.



# ELECTRICAL CONNECTION

- Remove the lid from the heat pump before removing the end panel to access the electrical connections.
- The power cable should be routed through the IP rated cable grip on the side of the unit and connect to the supply terminals in the control box.

Preconnected to unit

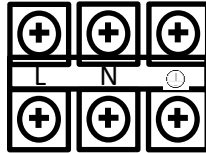

Wire to a suitable 230V Supply

The circuit must be RCD protected, and an all pole disconnection device must be installed in an accessible place close to the heat pump.

- Care should be taken when routing any cables, and high current cables such as the power cable should be routed through the top cable grip, and lower current cables through the lower cable grip. This will help to prevent interference and faults.
- The wired controller should then be wired into the black connector, which is pre-fitted to the unit, using the extension cable. If the supplied 10m extension cable is not long enough, this can be extended by splicing in a length of 5 core 0.5mm<sup>2</sup> cable, or a longer extension cable is available from the manufacturer.
- Any other auxiliary parts and sensors which require communication with the heat pump should also be connected at this point, following the circuit diagram within this manual. An extension cable for wiring up the DHW tank temperature sensor is provided with the heat pump.
- Once all the connections have been made, the side panel and top cover should be replaced on the unit and secured.

## EXTERNAL AUXILIARY ELECTRIC HEATER

The heat pump supports the wiring of an external auxiliary electric heater upto 600W, which can be connected to the relevant terminals on the unit, to provide extra heating power to the water tank when low ambient temperatures are experienced. See the circuit diagram on the unit to confirm the correct terminals to use.

If an electric heater rated above 600W is to be used, this should be connected via a suitable relay (not supplied), so that the heating element is still controlled by the heat pump, but the power is supplied externally. When connecting the relay, the circuit diagram provided with it must be followed.

## EXTERNAL 3 WAY VALVE

The heat pump supports the wiring of a 3 way valve, to direct the flow from the heat pump to either the Domestic hot water tank, or the buffer tank for central heating. See the circuit diagram on the unit to confirm the correct terminals to use.

# BEFORE FIRST OPERATION

## INSPECTION

Check the indoor system ensuring that all pipe connections are correct and that the relevant valves are open.

1. Check the water loop, to ensure that the water/glycol mixture inside of the expansion tank is adequate, the water supply is good, the water loop is full of water and that there is no air in the pipework.
2. Ensure that all pipework is adequately insulated.
3. Check the electrical wiring, to ensure that the voltage is correct, the screws are fastened and the wiring is made in line with the supplied diagrams.
4. Check the heat pump unit including all of the screws and parts of the heat pump to check that it is correctly reassembled and secure.
5. When powered on, review the indicator on the controller to see if there is any failure indication. Fault codes are provided later in this manual.
6. A pressure gauge can be connected to the check the valve to see the high pressure (or low pressure) of the system during trial running.







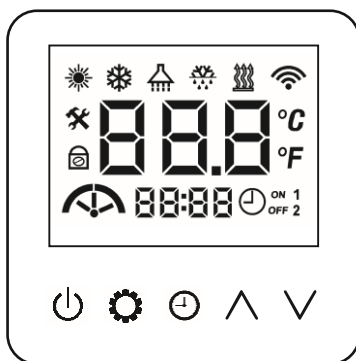





## TRIAL RUN

- Start the heat pump by pressing the  button on the controller. Check whether the water pump is running, if it runs normally there will be 0.2 MPa on the water pressure meter.
- When the water pump has been running for 1 minute, the compressor will start. Listen for whether there is a strange sound from the compressor. If an abnormal sound occurs, please stop the unit and check the compressor. If the compressor runs well check the pressure of the refrigerant, or contact the supplier.
- Adjust the valves on the water loop to make sure that the water supply to the inlet and outlet is sufficient and meets the requirements for heating (or cooling).
- Review whether the outlet water temperature is stable.

# OPERATION



BUTTON	MEANING	DESCRIPTION
	POWER	Turn the unit On or Off. Unlock the unit. Return the main interface.
	SETTINGS	Set the working mode. Enter the user parameter list menu. Set the parameters, confirm parameters and set temperature.
	TIMER	Enter the timer settings.
	UP	Increase the chosen value.
	DOWN	Decrease the chosen value.
	INSTALLER PARAMETERS	Used to amend the main system parameters (Installer / professional use only)
	SYSTEM QUERY	View the current operating parameters
	WIFI	Wi-Fi connection.
	WIFI SYMBOL	Turn on/ off the WiFi symbol on the display

ICON	DESCRIPTION		FUNCTION
	HEATING MODE	ON	Unit in Heating mode, but not providing heating
		FLASHING	The unit is in heating mode, and there is demand for heating
	COOLING MODE	ON	Unit in Cooling mode, but not providing cooling.
		FLASHING	The unit is in cooling mode, and there is demand for cooling.
	HOT WATER MODE	ON	Unit is in Hot water mode, but there is no demand for heating.
		FLASHING	There is a demand for hot water and the heat pump is providing heat.
<p>Note: The modes below can be combined into multi modes, and when combined the symbols above will be shown together. E.g. if the heating and hot water symbols are showing, the unit can provide both heating and hot water, and the symbol flashing will show whether the heat pump is providing heat to the DHW tank or buffer tank.</p>			
	DEFROST MODE	FLASHING	The defrost mode symbol to flash to indicate the heat pump has entered defrost mode.
	AXILLARY ELECTRIC HEATER / BACK UP HEATER	ON	The anti-legionnaires disease function is operating
		FLASHING	The auxiliary electric heater (or backup heater) are running.
	Wi-Fi	FLASHING	WiFi on but not connected
		ON	Connected to network
	TIMER	ON	Shows the timer is active
	WATER PUMP	ON	When shown indicates the water tank is running.
	PARAMETER	ON	Shows that the unit is in the parameter options
		FLASHING	Shows the current parameter has been amended
	LOCK	ON	Indicated the child lock is activated. Press and hold the POWER button for 5 seconds to unlock the control panel.
	FAN INDICATOR		When the icon is displayed, it indicates that the fan is running at maximum speed, if only the left side is displayed, the fan is running in low noise mode.
	COMPRESSOR INDICATOR		The 3 bars indicate the speed of the compressor. Left bar is low speed, middle is medium, and right is high speed.

## TURNING ON AND OFF







Press the POWER  button to turn the controller on and off. After 60 seconds of inactivity the screen will enter standby mode. Press any button to exit standby mode.

## CHILD LOCK

Press and hold the POWER  button to activate and deactivate the child lock. When the child lock is activated the lock symbol will be displayed on the display.



## SETTING THE TIME













When first turned on, the hour value will flash on the screen and the PARAMETER  symbol will be flashing.

- Use the UP and DOWN  +  buttons to adjust the hour value.
- Press the TIMER  button to confirm the hour value.
- The minute value will then start to flash.
- Use the UP and DOWN  +  buttons to adjust the minute value.
- Press the TIMER  button to confirm the time shown.

Note: If there is no input for 5 minutes, the currently shown time will be saved.

## CHOOSING THE MODE

Repeatedly press the SETTINGS  button to change between the modes. While making the change the PARAMETER  symbol will be displayed. The mode can be changed between the following:

MODE	ICON
HEATING MODE	
COOLING MODE	
DOMESTIC HOT WATER MODE	
AUTOMATIC MODE	 + 
HOT WATER + HEATING MODE	 + 
HOT WATER + COOLING MODE	 + 
DOMESTIC HOT WATER + AUTOMATIC MODE	 +  + 

## SETTING THE TEMPERATURE

Use the UP and DOWN  $\wedge$  +  $\vee$  buttons to adjust the desired temperature in the current mode. The symbol for the current mode will be displayed PARAMETER  $\otimes$  symbol will be flashing. The updated temperature will be saved after 5 minutes, alternatively press the POWER  $\text{⏻}$  button to save the temperature and return to the main screen. If you are in a multi-mode such as “domestic hot water and heating”, press the SETTINGS  $\text{⚙}$  button to change between the modes you are amending. The relevant mode icon will be displayed to show the mode you are currently editing.

## TEMPERATURE RANGES







The temperature that can be set, is dependant on the mode the unit is operating in, following the table below:

MODE	TEMPERATURE RANGE
Heating Mode	25°C ~ 60°C*
Heating Mode (Curve function Active)	20°C ~ 60°C*
Cooling Mode	7°C ~ 25°C.
Hot Water Mode	25°C ~ 60°C*

\* 55 °C when the ambient temperature is below 7°C

# TIMER

The controller includes Timers for each function, which enables you to set two periods of operation per day. To set the timers, press and hold the TIMER  button for 5 seconds. Within the timer menu:

- Use the UP and DOWN  +  buttons to select the option to adjust
- Press the SETTINGS  button to select the option
- Use the UP and DOWN  +  buttons to adjust the option (Time is adjusted in 30 minute increments)
- Press the SETTINGS  button to return to the timer list, ready to select the next option
- When finished press the POWER  button to exit.

No	Meaning	Range	Default
00	Heating timer function switch	0--OFF,1--ON	00
01	Heating timer 1 ON time	00 00-23 30	00:00
02	Heating timer 1 OFF time	00 00-23 30	00:00
03	Heating timer 2 ON time	00 00-23 30	00:00
04	Heating timer 2 OFF time	00 00-23 30	00:00
05	Cooling timer function switch	0--OFF,1--ON	00
06	Cooling timer 1 ON time	00 00-23 30	00:00
07	Cooling timer 1 OFF time	00 00-23 30	00:00
08	Cooling timer 2 ON time	00 00-23 30	00:00
09	Cooling timer 2 OFF time	00 00-23 30	00:00
10	Hot water timer function switch	0--OFF,1--ON	00
11	Hot water timer 1 ON time	00 00-23 30	00:00
12	Hot water timer 1 OFF time	00 00-23 30	00:00
13	Hot water timer 2 ON time	00 00-23 30	00:00
14	Hot water timer 2 OFF time	00 00-23 30	00:00
15	Low-noise timer function switch	0--OFF,1--ON	00
16	Low-noise timer 1 ON time	00 00-23 30	00:00
17	Low-noise timer 1 OFF time	00 00-23 30	00:00
18	Low-noise timer 2 ON time	00 00-23 30	00:00
19	Low-noise timer 2 OFF time	00 00-23 30	00:00

**Notes:**

- Activate the relevant timer first using the function switch, followed by setting the timer periods for operation.
- If multiple timers overlap, only the first timer will be followed.

## HEATING CURVE FUNCTION

The heating curve function, the water temperature is automatically adjusted based on the outdoor ambient temperatures, given that heating demand and performance is affected by the temperature outside.

The curve function sets the water temperature based on 5 ranges of outdoor temperature, which can help to provide better heating performance. This function works with outdoor ambient temperatures between -20°C and 45°C, and sets the water temperature between 20°C and 60°C.

OUTDOOR AMBIENT TEMPERATURE				WATER TEMPERATURE			
No	CURVE POINT	RANGE	DEFAULT	No	CURVE POINT	RANGE	DEFAULT
19	HCTA1	-20°C~45°C	-20	20	HCTs1	20°C~60°C	42
21	HCTA2		-7	22	HCTs2		35
23	HCTA3		2	24	HCTs3		31
25	HCTA4		7	26	HCTs4		28
27	HCTA5		12	28	HCTs5		25

The wired controller will create a heating curve based on the settings, to reach the desired water temperature based on the temperature outside. The below demonstrates the curve below, with the Ambient temperature across the bottom, and the water temperature on the vertical axis.

Note: Given the nature of the curve, all values must be in ascending order. E.g. the temperature for HCTA2 must

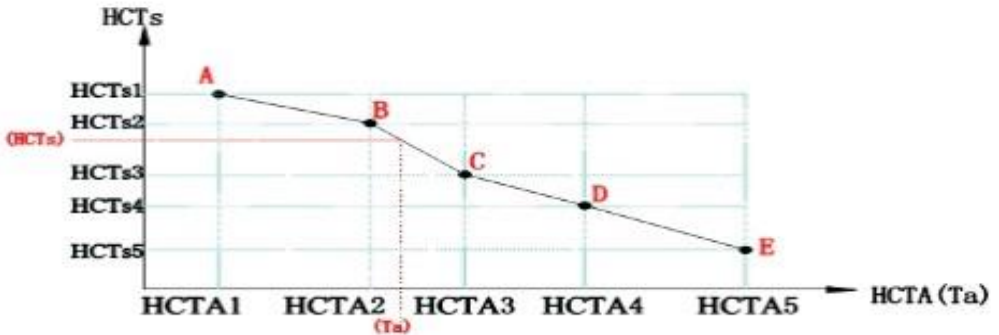

be above HCTA1, and below HCTA3. If a mistake is made when entering the values, and this is not followed, the value will automatically be corrected by the controller.

If while using the heating curve, the user adjusts the desired temperature using the controls, this will not deactivate the change, but instead the same change will be made to all other points on the curve. E.g. if HCTs4 is changed from 28 to 30°C, all other values of HCTs will also be increased by 2°C.

The heating curve function can be activated within the parameter list, please see the instructions on the following page on the options available (Parameters 16-18)



## ANTI-LEGIONELLA FUNCTION



When the DHW tank contains a heating element, the appliance has an anti-legionella function which is designed to once a week provide additional heating to the hot water tank to prevent the growth of bacteria within it.

This can be activated through the parameter list using options 41-43, which gives you the option to specify the day and time that the function will run each week.

## PARAMETER LIST

Hold the SETTINGS  button for 5 seconds to enter the Parameter list. This will enter the parameter screen as below and should be used in combination with the parameter table:



- Use the UP and DOWN  $\wedge + \vee$  buttons to select the parameter to amend
- Press the SETTINGS  button to choose the parameter to amend
- Use the UP and DOWN  $\wedge + \vee$  buttons to amend the value of the parameter.
- Press the SETTINGS  button to save the change

If there is no input for 5 minutes, the controller will exit the parameter menu and return to the main screen.

Please see the following page for details of the parameters that can be adjusted.

NO	NAME	RANGE	DEFAULT	NO	NAME	RANGE	DEFAULT
U01	Reserved	/	00	U23	Ambient temperature 3	20°C~45°C	02
U02	Hot water restarts based on water $\Delta T$	0°C~10°C	05	U24	Set water temperature 3	20°C-65°C	28
U03	Heating restarts based on water $\Delta T$	0°C~10°C	02	U25	Ambient temperature 4	-20°C~45°C	07
U04	Cooling restarts based on water $\Delta T$	0°C~10°C	02	U26	Set water temperature 4	20°C-65°C	28
U05	Reserved	/	00	U27	Ambient temperature 5	-20°C~45°C	12
U06	Heat pump low noise mode	0--off; 1--on; 2--Strong heat	00	U28	Set water temperature 5	20°C-65°C	28
U07	Automatic heating mode starting temperature	-10°C~20°C	20	U29	Reserved	/	00
U08	Automatic cooling mode starting temperature	21°C~35°C	25	U30	Whether the screen shows water outlet temperature in standby	0: Do not show 1: Show	01
U09	Reserved	/	00	U31	Activate heating source selecting function	0--off; 1--on	00
U10	Heating balance function	0--off;1--on	00	U32	Ambient temp.point 1(> point1, compressor +backup heater; $\leq$ point1; backup heater only)	-30~45°C	-15
U11	Ambient temperature of heating balance start-up	-15°C~15°C	-29	U33	Ambient temp. point 2 ( $\geq$ point 2, compressor only; < point 2, compressor + backup heater)	-30~45°C	00
U12	Heating balance restarts based on water $\Delta T$	3°C-20°C	05	U34	Cooling curve activation	0--off; 1--on	00
U13	Max. working hours of heating	20-180(minute)	20	U35	Ambient temperature 1	0~45°C	30
U14	Min. working hours of hot water	20-180(minute)	50	U36	Set water temperature1	7°C~25°C	15
U15	Emergency starting function of hot water heater in heating balance mode	0--off;1--on	00	U37	Ambient temperature 2 37 (> Ambient temperature 1)	0°C-45°C	35
U16	Heating curve function	0--off; 1--on	00	U38	Set water temperature 2	7°C~25°C	15
U17	Heating curve deviation function	0--off; 1--on	01	U39	Ambient temperature 3 (> Ambient temperature 2)	0°C~45°C	40
U18	Heating curve deviation interval time	10-60 (Minutes)	10	U40	Set water temperature 3	7°C~25°C	15
U19	Ambient temperature 1	20°C~45°C	-20	U41	Timer for anti-legionella function (by day in a week)	0-No timer (no anti-legionella) 1~7Timer on, Monday to Sunday	00
U20	Set water temperature 1	20°C-65°C	42	U42	Hour setting for anti-legionella	0~23	00
U21	Ambient temperature 2	20°C~45°C	-7	U43	Minute setting for anti-legionella	0-59	00
U22	Set water temperature 2	20°C-65°C	28				

## SYSTEM QUERY

To enter the system query mode press and hold the UP and DOWN  $\wedge + \vee$  buttons for 5 seconds to enter the query menu..



Use the UP  $\wedge$  button to scroll through the parameters. The parameters available to view are as shown below with their corresponding parameter numbers.

List of system operating parameters			
No	Meaning	No	Meaning
1	Ambient temperature	15	System discharge temperature
2	Hot water temperature	16	System suction temperature
3	Heating temperature	17	System defrost temperature (displays 0)
4	Cooling temperature	18	System Evaporation Pressure
5	Room temperature	19	System condensing pressure
6	Outlet water temperature	20	System expansion valve main valve opening
7	Inlet water temperature	21	Reserved (displays 0)
8	Tank temperature (displays 0)	22	Reserved (displays 0)
9	Indoor coil temperature	23	Reserved (displays 0)
10	System voltage	24	Main control board software version no.
11	System current	25	Main control board EEPROM version no.
12	System compressor frequency	26	Wired controller software version no.
13	System fan speed	27	Error code history (1)
14	System Evaporator Coil Temperature	28	Error code history (2)

If there is no input for 5 minutes, the controller will exit the query menu and return to the main screen.

# WIFI SETUP

## BEFORE YOU START

- Ensure your router provides a standard 2.4ghz connection.
- If your router is dual band ensure that both networks have different network names (SSID). The provider of your router / Internet service provider will be able to provide advice specific to your router.
- Place the air conditioner as close as possible to the router during setup.
- Once the app has been installed on your phone, turn off the data connection, and ensure your phone is connected to your router via WiFi.

## DOWNLOAD THE APP TO YOUR PHONE

Download the “MyHeatpump2” app from your chosen app store. Alternatively find the latest QR codes to download the app from: <http://www.myheatpump.com>.

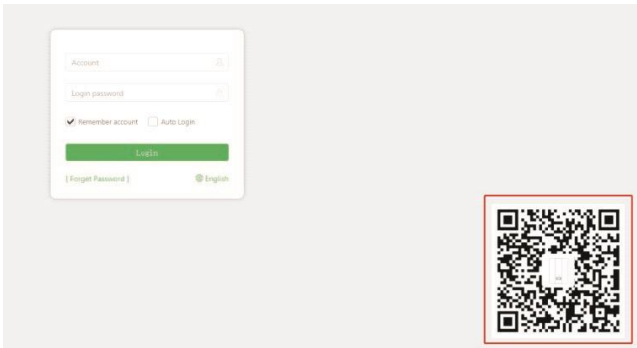

## SETUP THE APP

After installing the app onto your phone, open the app and use the register option to create an account, following the steps on screen.

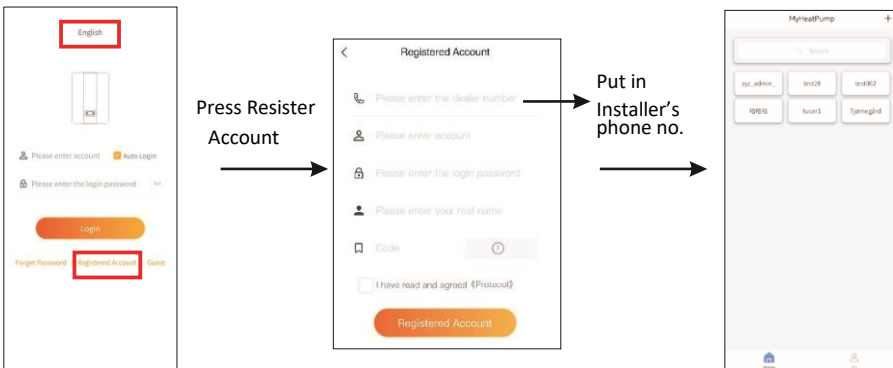

# LINKING THE HEAT PUMP TO YOUR WIFI

Connect your phone to your WiFi network. of the router, and then hold the POWER AND DOWN (⏻) buttons at the same time for 5 seconds. The WiFi icon will start to flash;

Open the app in your mobile phone and perform the following operations after logging in. Input your WiFi password. Then, press “Quick Binding”, the unit will then start to make the connection.

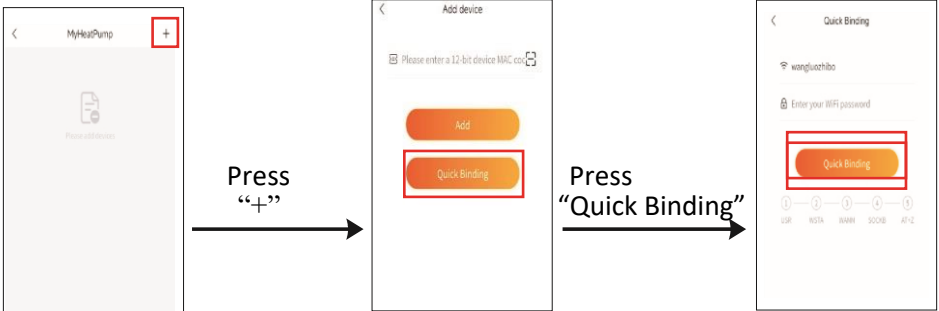

If the interface keeps loading for more than 2 minutes during the configuration process, then it means the configuration fails, Please try again



Once the binding has complete, press Confirm to finish the connection process. The Heat pump is now ready to connect.

# OPERATION



The Main interface for account allows you to view the devices connected to the app.

1. Shows the unit bound by the current account.
2. Extra compatible smart appliances can be added.

Press the unit icon to enter the unit operation screen

The operation screen allows you to both control the appliance and view operating parameters, as shown in the list below:

1. Turn ON/OFF the unit
2. Display failure code
3. Display unit status
4. Display current setting water temp. and current water temp.
5. Edit setting water temp., mode and timing.

	Switch to heating water temp. display and modify the heating set water temp.
	Switch to cooling water temp. display and modify the cooling set water temp.
	Switch to hot water temp. Display and modify the heating set water temp.
	Switch working mode (hot water, heating, cooling, hot water + heating, hot water + cooling).
	Enter the parameter setting interface and timing setting.

## **CLEANING AND MAINTENANCE**

- **DANGER!** The unit contains flammable refrigerant. Work should only be carried out if it can be conducted without risking damage to the refrigerant circuit. If you are unsure, a suitably qualified engineer must be used.
- Ensure that the unit is kept in a well-ventilated area, to prevent the risks associated with leakage.
- Basic safety rules should be observed when carrying out inspection and/or maintenance on the unit.

### **CLEANING**

- Do not clean the product with a high-pressure cleaner, or water jets.
- Clean the product using a sponge with warm water and a soap solution
- Do not use abrasive cleaners or solvents. Do not use any cleaning agents that contain chlorine or ammonia

### **BEFORE FIRST USE / AFTER STORAGE**

Before starting the unit for the first time, or after a period of non-use, the following should be followed:

- Thoroughly inspect and clean the unit.
- Check the water pump, regulating valve and other parts of the system to ensure they are clean and functioning correctly.
- Ensure all terminals within the system are tight.
- Ensure that the water refill and vent devices are in good condition, as this may affect the performance and reliability of the unit.

### **PERIODIC MAINTENANCE**

Periodic maintenance should be conducted roughly every six months. The power should be disconnected before conducting any maintenance.

- 1) Inspect the heat exchanger, and where necessary they should be cleaned to ensure they are in optimum condition for heat transfer.
- 2) Check the water-side heat exchanger, and where necessary de-scale.
- 3) Check the electrical connections for any signs of deterioration, oxidation or damage. Any parts which are showing signs of excessive wear should be replaced.

### **CHECKING THE EVAPORATOR, FAN AND CONDENSATE DISCHARGE**

- Check whether there is dirt on the fins, if so they should be cleaned using a soft brush to prevent damage.
- Check whether the condensate tray is clean and that water drains through the drain pipe.

## FAULT CODES

The appliance contains a large number of sensors and intelligent logic, enabling it to provide information on any faults or abnormal conditions encountered. These are displayed and logged through the wired controller.

Failure Codes			
Code	Failure	Controller Processing	Possible Reasons and Solutions
P01	Main line current protection	Unit stops for protection	If the current is too high or too low, the unit stops for protection. Unit recovers automatically after 5 minutes when it happens the first time. If the same failure happens for 3 consecutive times, unit stops until re-powered. If the unit is overloaded, check the heat exchange situation of the condensing side, whether the fan motor or water pump is working OK, whether the heat exchanger is blocked, whether the water temperature is too high, and whether the actual temperature difference between the inlet water and outlet water of the heat exchanger is normal (below 8°C).
P02	Compressor phase current protection	Unit stops for protection	Too high or too low compressor current protection, or unit is overloaded. Check heat exchanger situation of the condensing side to see whether the fan motor or water pump is working OK, whether the heat exchanger is blocked, whether the water temperature is too high and the actual temperature difference between the water inlet and outlet of the heat exchanger is normal (below 8°C).
P03	IPM module protection	Unit stops for protection	The drive board has failure. Check whether cables are loose. If the cables are connected well, replace drive board. If failure still exists, replace compressor.
P04	Compressor oil return protection	Outdoor controller protection	If the unit operates in low-frequency F3 for more than 20 minutes, it causes poor oil return, which is normal protection and needs no treatment.
P05	High pressure switch protection	Unit stops for protection	If the system pressure exceeds the set value of the pressure switch, unit stops for protection. Unit recovers automatically after 5 minutes when it happens the first time. If the same failure happens for 3 consecutive times, unit stops until re-powered. Check the heat exchange situation of the condensing side, whether the fan motor or water pump is working OK, whether the heat exchanger is blocked, whether the water temperature is too high, and whether the actual temperature difference between the inlet water and outlet water of the heat exchanger is normal (below 8°C).
P06	High pressure protection	Unit stops for protection	If the system pressure reaches the pressure protection value, check whether the water temperature is set too high, the water flow is too small, the expansion valve control is abnormal, the outside ventilation is poor while cooling, or the ambient temperature is too high. If it happens three times in half an hour, the failure code will turn into F12.
P07	Compressor preheating protection	Outdoor controller protection	When the system is powered on below-5°C, this is a normal protection and doesn't need any treatment, and the protection will be cleared out after 30minutes.
P08	Too high compressor discharge temp. protection	Unit stops for protection	The discharge temperature is too high, the water temperature is set too high when ambient temperature is low, the water flow is too small, or the unit lacks refrigerant.
P09	Outdoor evaporator coil temp. sensor protection	Unit stops for protection	There is too high outdoor evaporator coil temperature at cooling or the air volume is too small. Check whether the air outlet is blocked. Too low Indoor coil temperature protection while cooling, check the water flow. Refer to P05, if the same failure happens three times in half an hour, the unit stops until re-powered.



P10	Too high/low input voltage protection	Unit stops for protection	Check whether unit input voltage is too high ( $\geq 270V$ ) or too low ( $\leq 140V$ )
P11	Compressor shut down due to too high/low ambient temperature	Unit stops for protection	The ambient temperature exceeds the allowable working range The working range of cooling is 11~55°C; The working range of heating is-30~45°C.
P14	Anti-freezing protection-stage 1	The circulation pump stops for 6 minutes and then work for 1 minute.	System security protection.
P15	Anti-freezing protection-stage 2	If the ambient temperature and the water outlet temperature are lower than the set starting temperature, the heat pump starts working. If the water outlet temperature is higher than the set target temperature or if the ambient temperature is higher than the set ambient temperature for closing activation, the stage-2 anti-freezing protection exits.	System security protection.
P18	Low pressure protection	Unit stops for protection	The low pressure is lower than protection value, the water flow is too small, the expansion valve control is abnormal, the outside ventilation is poor during cooling, or the ambient temperature is too high. If the same failure happened 3 times in half an hour, the failure code turns into F11;
F01	Outdoor ambient temp. sensor failure	Unit stops for protection	Outdoor ambient temp. sensor is disconnected or short-circuited. Change the Ta sensor. When this failure happens only when the unit is working, the ambient temp. sensor and the coil temp. sensor may be misplaced.
F02	Outdoor coil temp. sensor failure	Unit stops for protection	Outdoor coil temp. sensor is disconnected or short-circuited. Replace the Tp sensor.
F03	Compressor discharge temp. sensor failure	Unit stops for protection	Compressor discharge temp. sensor is disconnected or short-circuited. Replace the Td sensor.
F04	Compressor suction temp. sensor failure	Unit stops for protection	Compressor suction temp. sensor is disconnected or short-circuited. Replace the Ts sensor.
F05	Evaporating pressure sensor failure	Unit stops for protection	Evaporating pressure sensor is disconnected or short-circuited or there is component fault. Replace it if necessary. or EEPROM setting is wrong.
F06	Condensing pressure sensor failure	Unit stops for protection	Condenser pressure sensor is disconnected or short-circuited. Replace it if necessary. or EEPROM setting is wrong.
F07	High pressure switch failure	Unit stops for protection	1. If high pressure switch is in open position when unit is in standby statue, or 2 minutes after compressor stops, unit gives this failure.; 2. P05 pressure switch protection has happened for three times, and then it becomes F07. It only recovers until re-powered. Check whether high- or low-pressure switch is broken or not well connected. Whether the water flow is too small, whether water outlet temp. Sensor is loose or damaged, whether fan motor or EEV works abnormal; whether unit works in cooling when ambient temp. is too high.

F08	Low pressure switch failure	Unit stops for protection	1. If low pressure switch is in open position when unit is in standby statue, or 2 minutes after compressor stops, unit gives this failure.; 2. P13 pressure switch protection has happened for three times, and then it becomes F08. It only recovers until re-powered. Check whether low pressure reaches the protection value or low-pressure switch is broken. Check whether water flow is too small; whether EEV works abnormal; whether the ventilation is good at cooling; whether fan motor works abnormal in low ambient temp.; whether the unit lacks of refrigerant.
F09	DC fan motor A failure	Reduce speed for protection (double fan system) or compressor shutdown (single fan system). For double fan system, if two fans fail at the same time, the compressor stops.	DC fan motor can't reach the required speed or no feedback signal. Please check whether the PCB or fan motor is broken. Replace it if necessary; or EEPROM is set to AC motor by mistake.
F11	System evaporating pressure failure	Unit stops for protection	If too low-pressure protection detected by evaporating pressure sensor happened 3 times in half an hour, P18 becomes F11. Check whether system has not enough refrigerant or leakage inside, more likely it has no enough refrigerant that caused this abnormal evaporating pressure; whether fan motor and water pump is working OK; whether evaporator is blocked; whether EEV whether EEV works normally; whether water temperature too low, and whether water inlet & outlet temperature has too big difference in cooling(should no bigger than 8°C).
F12	System condensing pressure too high	Unit stops for protection	If system too high-pressure protection detected by condensing pressure sensor happened 3 times in half an hour, it gives this failure code and unit can't be restarted until re-powered. Check whether water flow rate is not enough, more likely it has no enough water flow rate that caused system build up too high pressure; whether fan motor and water pump is working OK; whether condenser is blocked; whether EEV works normally; whether water temperature too high, and whether water inlet & outlet temperature has too big difference (should no bigger than 8°C).
F14	Hot water temp. sensor failure	Hot water mode stops working	Hot water mode stops working. Replace the Tw sensor.
F16	Water outlet temp.	Unit shutdown for protection	Tuo
	sensor failure		The water outlet temp. sensor is disconnected or short-circuited. Replace the Tuo sensor.
F17	water inlet temp. sensor failure	Unit shutdown for protection	The water inlet temp. Sensor Tui is disconnected or short-circuited. Replace the Tui sensor.
F18	Indoor coil temp.	Unit shutdown for protection	Tup
	sensor failure		Indoor coil temp. sensor Tup is disconnected or short-circuited. Replace the Tup sensor.
F27	Indoor EEPROM failure	Treatment is not needed but the unit runs with reset values	Reset the EEPROM setting or replace the indoor PCB
E01	Communication failure between indoor main control PCB and outdoor main control PCB	Unit stops for protection	The RS485 communication cable AB is disconnected or wrongly connected, or the PCB is damage. Check and replace them.

E02	Communication failure between outdoor main PCB and compressor driver board	Unit stops for protection	The communication cable is disconnected or the driver board is damaged. Check and replace them.
E03	Compressor phase current failure (open/short circuit)	Unit stops for protection	Check whether the power cable to compressor is broken or short-circuit or not well connected. Replace the cable. Whether the unit lack of refrigerant, refill it. If cable and refrigerant are OK, replace the driver PCB.
E04	Compressor phase current overload (too high current)	Unit stops for protection	Check whether the power cable to compressor is broken or short-circuit or not well connected. Replace the cable. Whether the unit lack of refrigerant, refill it. If cable and refrigerant are OK, replace the driver PCB.
E05	Compressor driver board failure	Unit stops for protection	The driver board is damaged or the cable between driver board and compressor is loose. Check and replace them.
E06	Compressor driver board over high/low voltage failure	Unit stops for protection	Check whether input voltage is too high ( $\geq 270V$ ) or too low ( $\leq 140V$ ) .
E07	AC current failure	Unit stops for protection	1. Check whether the PCB is damaged. Use an ammeter to measure the current of the outdoor unit, and compare it with the current value in the system parameters on the display screen. If the two values have large difference, it indicates that the PCB is damaged and needs to be replaced. 2. If the measured current is too small, please check whether unit lacks of refrigerant; 3. The L line of the normally open relay of the power board is connected to the module board without passing through the transformer, resulting in current 0A;
E08	EEPROM failure	Unit stops for protection	Re-program the EEPROM, because the default EEPROM may not be suitable for this model configuration;
S01	Anti-freezing protection in cooling	Unit stops	1. The water temperature is too low and the water flow is too small during cooling. Check whether the water temperature setting is too low, whether the water system is normal, whether the filter is blocked, and whether the water pump is running normally.
			2. The amount of refrigerant is too small, check the low pressure to see whether it is necessary to add refrigerant. 3. When the ambient temperature is lower than 15°C, cooling is started. This fault may occur.
			4. If it has occurred three times within 30 minutes, and it cannot restart unless re-powered.
S02	Water flow switch protection	Restart after three minutes of shutdown	1. If the water flow is lower than 50% of the rated flow, check whether the water circuit is normal, whether the filter is blocked, and whether the water pump is running normally. 2. S02 turns into S10 when it happens three times within 30minutes.
S03	Water flow switch failure	When the water pump is not working, the water flow switch is open and it will be restored;	When the unit is in shutdown or standby state, if water flow switch is closed (ON), check whether the water flow switch is damaged or stuck.
S04	Communication failure between operation panel and indoor PCB	Unit stops	1. check whether the communication cable is connected correctly;2. Check whether the communication cable is too long (more than 30 meters) and whether there is an interference source near the unit. If so, add an anti-interference magnetic ring to the communication cable; 3.The operation panel or the indoor PCB is broken.
			Replace it with a new one.

S06	Too low water outlet temp. protection in cooling	Unit stops	When water outlet temperature is too low during cooling, check whether the outlet water temperature sensor is connected well, whether the water temperature setting is too low, and whether the water flow is too small.
S07	Water outlet Temp. too high protection in heating/hot water.	Compressor stops	Compressor stops if water outlet is higher than 57°C in heating or hot water mode. Check whether temperature sensor Tc and Tw is OK and well connected; whether set water temperature too high; whether system flow rate too small.
S09	Defrosting failure	Unit stops	When the water outlet temperature $\leq 5^{\circ}\text{C}$ , and if the defrosting fails for three consecutive times, this fault will be reported continuously and just can be cleared out after re-power.
S10	water flow switch failure	The heat pump stops working and cannot be restored unless powered off	If the water flow is lower than 50% of the rated flow, check whether the water circuit is normal, whether the filter is blocked, and whether the water pump is working normally.
			2. Whether the water flow switch is stuck; 3. S02 turns into S10 after the failure happened three times within 30 minutes.
S11	Anti-freezing protection failure in cooling	The heat pump stops working and cannot be restored unless powered off	If "indoor coil anti-freezing protection in cooling mode" happens over 3 times in certain period of time, it gives this failure code and unit stops until re-power. 1.Check whether set temperature for cooling is too low; whether system has too small water flow rate; check water system especially the filter.2. Check whether system has not enough refrigerant inside by measuring the evaporating pressure.
			3.Check whether ambient temperature is lower than 15°C.

## TROUBLESHOOTING

Failure	Cause	Solution
Unit can't start up	No power supply	Check the power supply
	Fuse is broken or circuit breaker is disconnected	Check if it's open circuit or if the unit is earthed. Then change a fuse and reset the breaker, check if the circuit is stable or the connection is well.
	Some kind of protection works	Check which protection is working, and clear the protection, then restart the unit.
	Wiring is loose	Check the wire connection and tighten the screws on th terminal
	compressor fails	Change a compressor
Fan fails to run	Fan motor wire loose	Check the wire connections.
	fan motor failure	Change fan motor.
Low heating performance	The coil fins are very dirty	Clean the evaporator coil
	Air inlet is blocked	Remove any object that blocks the air circulation of the unit.
	Insufficient of refrigerant	Inspect the unit for leakage and fix it if any. Discharge all refrigerant and charge the unit again with correct amount.
Too high noise from the water pump, or no water flow when the water pump is running	Lacking of water in water system	Check the water filling device. Fill the system with enough water.
	Air exists in water system	Purging the air out.
	Valves in water system are not completely opened	Check all the valves to ensure they are fully opened.
	Water filter is dirty or blocked	4. Clean the water filter
Too high compressor discharge pressure	Too much refrigerant	Discharge all refrigerant and charge the unit again with right amount.
	Air exists in refrigeration system	Discharge all refrigerant and charge the unit again with right amount.
	Inadequate water flow	Check the water flow of the system. Use a bigger pump to increase the water flow if necessary.
	Too high water temperature	Check the value of the water temperature sensor, to ensure it works properly.
Too low suction pressure	Drier filter is blocked	Change a new one
	Electronic expansion valve is not opened	Repair or change a new one
	Leakage of refrigerant	Inspect the unit for leakage and fix it if any. Discharge all refrigerant and charge the unit again with right amount.
Unit can not defrost properly	Coil temperature sensor failure	Check the position and value of the coil temperature sensor. Replace it if necessary.
	Air inlet/outlet is blocked	Remove any object that blocks the air circulation of the unit. Clean the evaporator coil occasionally.

Diagram may change – Please see the version attached to the appliance for the diagram specific to your unit

# WIRING DIAGRAM

NCJXT00421A00-E

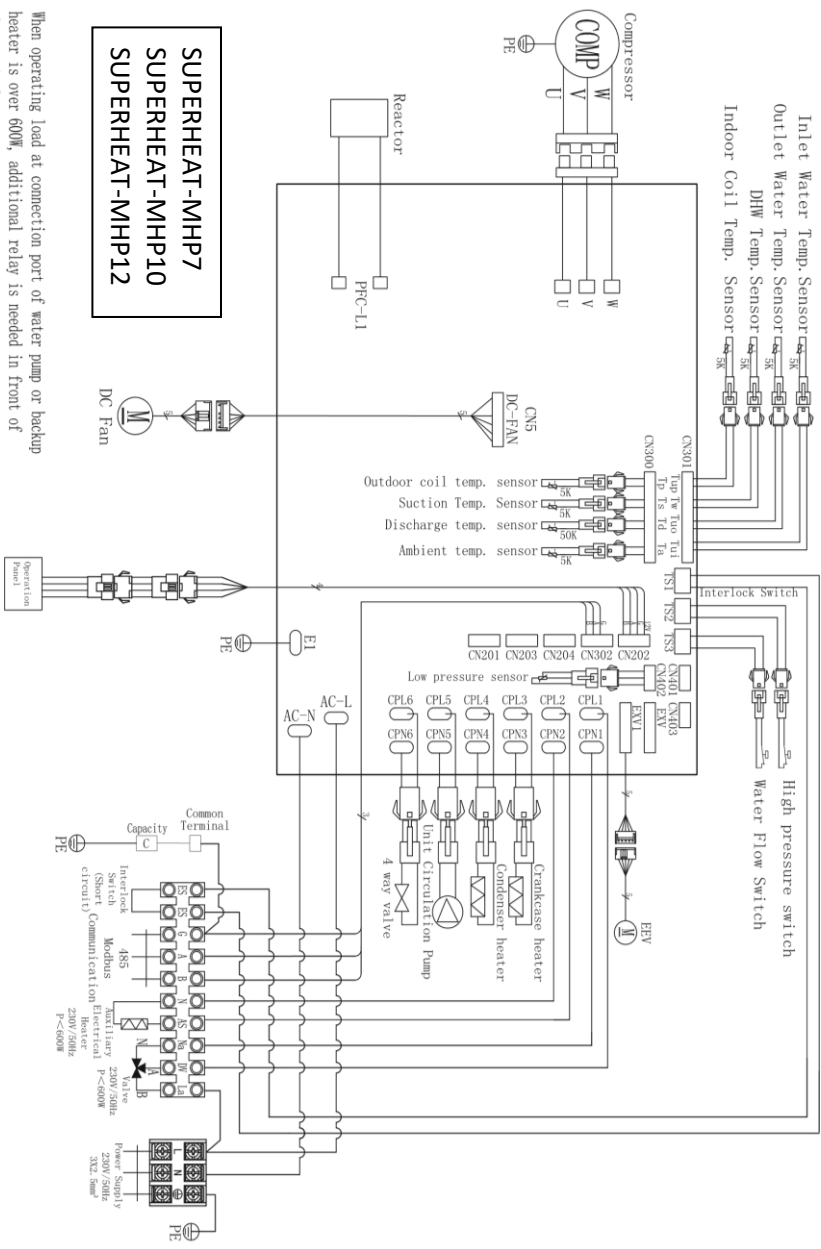

**SUPERHEAT-MHP7**  
**SUPERHEAT-MHP10**  
**SUPERHEAT-MHP12**

When operating load at connection port of water pump or backup heater is over 600W, additional relay is needed in front of the terminals.

# SUPERHEAT-MHP19

# WIRING DIAGRAM

Wire connector

NCJXT00494A00-A

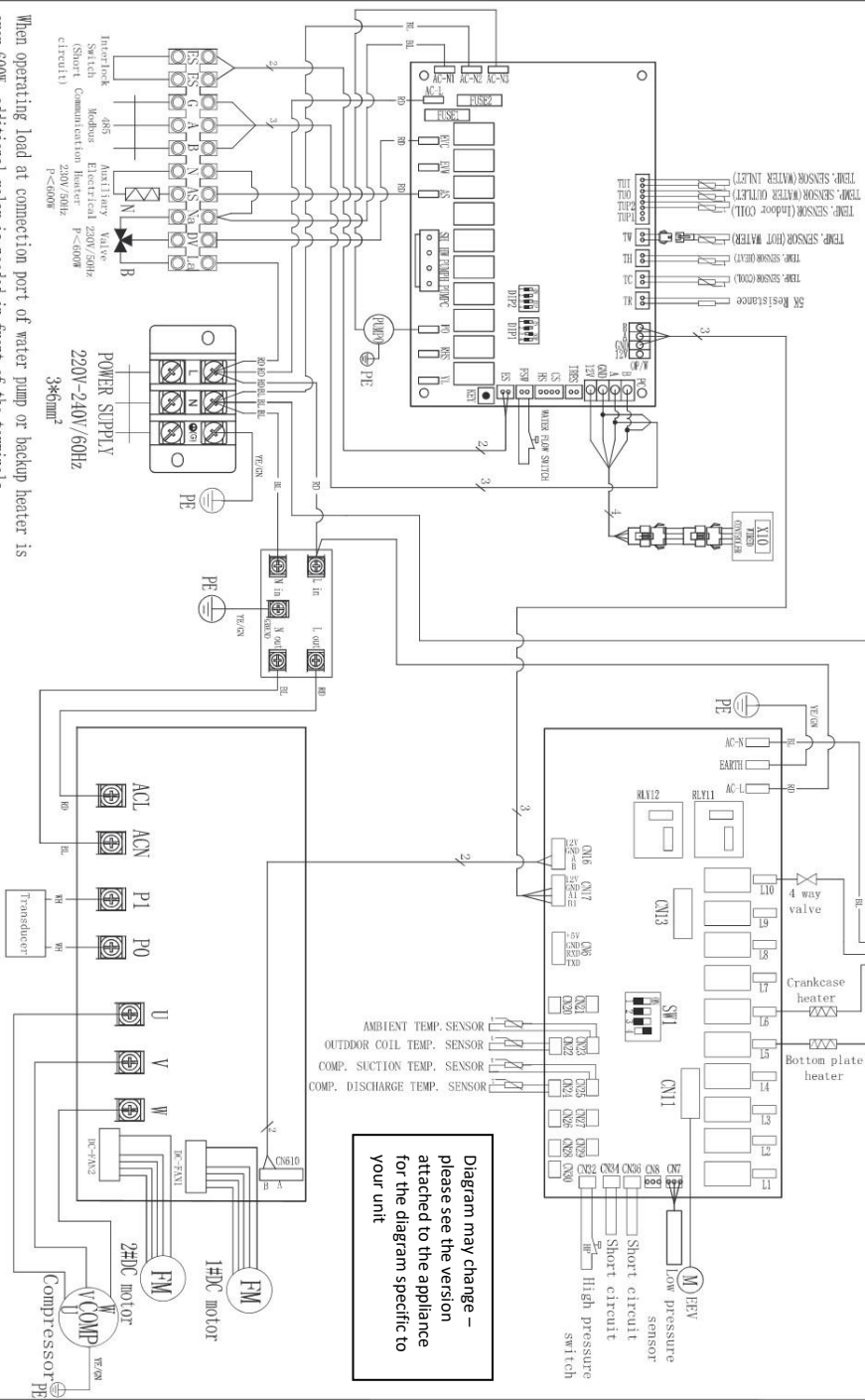











When operating load at connection port of water pump or backup heater is over 600W, additional relay is needed in front of the terminals.

## INSTALLER PARAMETERS

The installer parameters enables the installer to adjust some of the settings that are specific to the installation of the appliance. The installer parameters should only be adjusted by professionals with a good working knowledge of the unit, or following instruction provided by the manufacturer.

To access the Installer Parameters:

- 1) Press and hold the  +  buttons
- 2) Use the  +  buttons to enter the password, and the  button to confirm each digit. (default password: 138)
- 3) Once the password is entered press the  button to enter the installer parameters.
- 4) Use the  +  to scroll through the parameters, and  to adjust the value of the item selected.
- 5) Once you have made the required changes, press the POWER  button to exit.

NO.	Description	Range	Default value
1	User level	1	1
2	Reserved		
3	Remote switch function	0- Off, 1- Control the entire machine, 2- Control heating/cooling	2
4	Return temperature difference for frequency reduction	2°C-10°C	2
5	Model 【 controller 】	0-hot water 1-cooling and heating 2-heating+cooling+hot water 3-heating 4-hot water+heating	2
6	Low frequency F1 operation duration time	10min-60min	20
7	Reserved		
8	Reserved		
9	Heating priority in dual mode	0- Hot water priority, 1- Heating priority	0
10	Reserved		
11	Reserved		
12	High temperature sterilization function	0- off, 1- on	1
13	Sterilization set water temperature	60°C-75°C	75
14	Sterilization duration	10min-60min	30
15	The longest working time for sterilisation operation	10min-240min	120
16	Reserved		
17	Reserved		
18	The stop time of the circulating water pump (stop N and start)	0-Off, 1-60 (minutes) - Function active, stop time	6
19	Working category of circulating water pump	0- Start stop with logic 1-60 (minutes) The water pump will automatically set to 0 after being forced to start for a set time 61- Always on when starting up	0



20	Reserved		
21	Reserved		
22	Reserved		
23	Reserved		
24	Reserved		
25	Reserved		
26	Reserved		
27	Three way valve heating end configuration	0- Shared with hot water end, 1- Shared with cooling end	1
28	Emergency start function for electric heating of hot water tank	0- off, 1- on	1
29	Reserved		
30	Reserved		
31	Hot water capacity judgment cycle	1min-120min	15
32	Emergency start function of backup heat source for heating	0- off, 1- on	1
33	Reserved		
34	Reserved		
35	Integral of backup heat source capacity for heating	0-250(minute*°C)	45
36	Backup heat source activation mode	0-- Off 1- Backup heat source is only effective in heating mode 2- Backup heat source is only effective in hot water mode 3- Backup heat source is effective in both hot water and heating modes	3

# WATER QUALITY REQUIREMENTS

## Corrosive resistance of stainless steel and brazed materials in tap water at room temperature

<b>+</b>	Good corrosion resistance under normal conditions
<b>0</b>	There may be corrosion - Not recommended

Moisture	Concentration	Time limit	Plate material			Brazing material		
			AISI 304	AISI 316	254 SMO	Cuprum	Nickel	SS
Alkalinity (HCO <sup>-3</sup> )	<70	24h	+	+	+	0	+	+
	70-300		+	+	+	+	+	+
	>300		+	+	+	0/+	+	+
Sulphate (So <sup>-2-4</sup> )	<70	unlimited	+	+	+	+	+	+
	70-300		+	+	+	0/-	+	+
	>300		+	+	+	-	+	+
HCO/SO <sup>2-3</sup>	>1.0	unlimited	+	+	+	+	+	+
	<1.0		+	+	+	0/-	+	+
Electrical conductivity	<10	unlimited	+	+	+	0	+	+
	10-500		+	+	+	+0	+	+
	>500		+	+	+	+	+	+
pH	<6.0	24H	0	0	0	0	+	0
	6.0-7.5		+	+	+	0	+	+
	7.5-9		+	+	+	0	+	+
	>9		+	+	+	+0	+	+
Ammonium (NH <sup>+</sup> )	<2	24H	+	+	+	+0	+	+
	2-20		+	+	+	-	+	+
	>20		+	+	+	+	+	+
Chloride (Cl <sup>-</sup> )	<10	unlimited	+	+	+	+	+	+
	100-200		0	+	+	+	+	+
	200-300		-	+	+	+	+	+
	>300		-	-	+	0/+	+	-

**Disposal: Do not dispose of this product as unsorted waste. Collection of such waste must be handled separately as special treatment is necessary.**



Recycling facilities are now available for all customers at which you can deposit your old electrical products. Customers will be able to take any old electrical equipment to participating sites run by their local councils. Please remember that this equipment will be further handled during the recycling process, so please be considerate when depositing your equipment. Please contact the local council for details of your local household waste recycling centre

## TECHNICAL DATA

Manufacturer model		PAVH-06V1FXC	PAVH-09V1FXC	PAVH-12V1FXC	PAVH-15V1FXC
Supplier Model		SUPERHEAT-MHP7	SUPERHEAT-MHP10	SUPERHEAT-MHP12	SUPERHEAT-MHP19
MCS Number		MCS HP0296/01	MCS HP0296/02	MCS HP0296/03	MCS HP0296/33
Heating Capacity	kW	3.3 ~ 7.2	5.0 ~ 9.7	5.9 ~ 11.9	6.6~18.8
Heating Power Input	kW	0.7 ~ 1.6	1.0 ~ 2.4	1.3 ~ 2.9	1.3~4.6
Cooling Capacity	kW	1.8 ~ 4.8	3.1 ~ 7.9	4.2 ~ 8.9	4.7~13.1
Cooling Power Input	kW	0.66 ~ 2.54	1.1 ~ 3.2	1.6 ~ 3.1	1.5~4.6
Hot Water Capacity	kW	3.4 ~ 6.7	5.9 ~ 9.6	6.3 ~ 11.3	6.3~17.0
Hot Water Power Input	kW	1.2 ~ 2.3	2.0 ~ 3.8	2.0 ~ 3.9	2.0~5.7
Max Power Input	kW	2.3	3.76	3.87	6.74
Max Current Input	A	10	16.3	16.8	29.3
Power Supply		220-240V~/50Hz	220-240V~/50Hz	220-240V~/50Hz	220-240V~/50Hz
Power Cable CSA		3x2.5mm <sup>2</sup>	3x2.5mm <sup>2</sup>	3x4.0mm <sup>2</sup>	3x4.0mm <sup>2</sup>
MCB Rating	A	16	20	25	32
Compressor Quantity		1	1	1	1
Compressor Model		Rotary	Rotary	Rotary	Rotary
Fan Quantity		1	1	1	2
Fan Power Input	W	60	62	62	124
Airflow	M3/h	2500	3280	3280	6200
Water Pump Input	W	45	95	95	140
Noise	dB(A)	54	57	58	61
Water Connection	Inch	1" inner groove	1" inner groove	1" inner groove	1.25" Inner groove
Water Flow Volume	m <sup>3</sup> /h	1	1.6	2.06	2.58
Internal Water Pressure Drop	kPa	22	25	26	30
Water Head	M	6	9	9	11
Refrigerant		0.75kg R32	1.15kg R32	1.3kg R32	2.6kg R32
Unit Shipping Dimensions LxWxH	mm	1060x470x865	1230x470x1020	1230x470x1020	1150x470x1580
Unit Dimensions LxWxH	mm	1014x379x697	1174x379x846	11754x379x846	1094x403x1440
Net Weight	Kg	70	85.5	87	138

\*Please check online manual for MCS number

# UK SUPPORT

energysupport@buyitdirect.co.uk  
Call: 0330 390 3062

Office hours: 9AM - 5PM Monday to Friday

Buy It Direct (Importer)  
Unit 2A, Trident Business Park,  
Neptune Way, Leeds Road, Huddersfield, HD2 1UA

V20240227