

▶ BPE742320M
BPK742320B
BPK742320M

EN User Manual
Oven

USER MANUAL



AEG

CONTENTS

1. SAFETY INFORMATION.....	2
2. SAFETY INSTRUCTIONS.....	4
3. PRODUCT DESCRIPTION.....	7
4. CONTROL PANEL.....	8
5. BEFORE FIRST USE.....	10
6. DAILY USE.....	11
7. CLOCK FUNCTIONS.....	14
8. AUTOMATIC PROGRAMMES.....	15
9. USING THE ACCESSORIES.....	16
10. ADDITIONAL FUNCTIONS.....	19
11. HINTS AND TIPS.....	21
12. CARE AND CLEANING.....	37
13. TROUBLESHOOTING.....	40
14. ENERGY EFFICIENCY.....	42

FOR PERFECT RESULTS

Thank you for choosing this AEG product. We have created it to give you impeccable performance for many years, with innovative technologies that help make life simpler features you might not find on ordinary appliances. Please spend a few minutes reading to get the very best from it.

Visit our website for:



Get usage advice, brochures, trouble shooter, service information:

www.aeg.com/webselfservice



Register your product for better service:

www.registeraeg.com



Buy Accessories, Consumables and Original spare parts for your appliance:

www.aeg.com/shop

CUSTOMER CARE AND SERVICE

Always use original spare parts.

When contacting our Authorised Service Centre, ensure that you have the following data available: Model, PNC, Serial Number.

The information can be found on the rating plate.

 Warning / Caution-Safety information

 General information and tips

 Environmental information

Subject to change without notice.

1. SAFETY INFORMATION

Before the installation and use of the appliance, carefully read the supplied instructions. The

manufacturer is not responsible for any injuries or damages that are the result of incorrect installation or usage. Always keep the instructions in a safe and accessible location for future reference.

1.1 Children and vulnerable people safety

- This appliance can be used by children aged from 8 years and above and persons with reduced physical, sensory or mental capabilities or lack of experience and knowledge if they have been given supervision or instruction concerning the use of the appliance in a safe way and understand the hazards involved.
- Do not let children play with the appliance.
- Keep all packaging away from children and dispose of it appropriately.
- Keep children and pets away from the appliance when it operates or when it cools down. Accessible parts are hot.
- If the appliance has a child safety device, this should be activated.
- Children shall not carry out cleaning and user maintenance of the appliance without supervision.
- Children aged 3 years and under must be kept away from this appliance when it is in operation at all times.

1.2 General Safety

- Only a qualified person must install this appliance and replace the cable.
- **WARNING:** The appliance and its accessible parts become hot during use. Care should be taken to avoid touching heating elements. Children less than 8 years of age shall be kept away unless continuously supervised.
- Always use oven gloves to remove or put in accessories or ovenware.
- Before carrying out any maintenance, disconnect the appliance from the power supply.

- Ensure that the appliance is switched off before replacing the lamp to avoid the possibility of electric shock.
- Do not use a steam cleaner to clean the appliance.
- Do not use harsh abrasive cleaners or sharp metal scrapers to clean the glass door since they can scratch the surface, which may result in shattering of the glass.
- If the mains power supply cable is damaged, it must be replaced by the manufacturer, its Authorised Service Centre or similarly qualified persons to avoid an electrical hazard.
- Excessive spillage must be removed before the pyrolytic cleaning. Remove all parts from the oven.
- To remove the shelf supports first pull the front of the shelf support and then the rear end away from the side walls. Install the shelf supports in the opposite sequence.
- The means for disconnection must be incorporated in the fixed wiring in accordance with the wiring rules.
- Use only the food sensor (core temperature sensor) recommended for this appliance.

2. SAFETY INSTRUCTIONS

2.1 Installation



WARNING!

Only a qualified person must install this appliance.

- Remove all the packaging.
- Do not install or use a damaged appliance.
- Follow the installation instruction supplied with the appliance.
- Always take care when moving the appliance as it is heavy. Always use safety gloves and enclosed footwear.
- Do not pull the appliance by the handle.
- Keep the minimum distance from the other appliances and units.
- Make sure that the appliance is installed below and adjacent safe structures.

- The sides of the appliance must stay adjacent to appliances or to units with the same height.
- The appliance is equipped with an electric cooling system. It must be operated with the electric power supply.

2.2 Electrical connection



WARNING!

Risk of fire and electrical shock.

- All electrical connections should be made by a qualified electrician.
- The appliance must be earthed.
- Make sure that the parameters on the rating plate are compatible with the electrical ratings of the mains power supply.

- Always use a correctly installed shockproof socket.
- Do not use multi-plug adapters and extension cables.
- Make sure not to cause damage to the mains plug and to the mains cable. Should the mains cable need to be replaced, this must be carried out by our Authorised Service Centre.
- Do not let mains cables touch or come near the appliance door, especially when the door is hot.
- The shock protection of live and insulated parts must be fastened in such a way that it cannot be removed without tools.
- Connect the mains plug to the mains socket only at the end of the installation. Make sure that there is access to the mains plug after the installation.
- If the mains socket is loose, do not connect the mains plug.
- Do not pull the mains cable to disconnect the appliance. Always pull the mains plug.
- Use only correct isolation devices: line protecting cut-outs, fuses (screw type fuses removed from the holder), earth leakage trips and contactors.
- The electrical installation must have an isolation device which lets you disconnect the appliance from the mains at all poles. The isolation device must have a contact opening width of minimum 3 mm.
- This appliance complies with the E.E.C. Directives.

2.3 Use



WARNING!

Risk of injury, burns and electrical shock or explosion.

- This appliance is for household use only.
- Do not change the specification of this appliance.
- Make sure that the ventilation openings are not blocked.
- Do not let the appliance stay unattended during operation.
- Deactivate the appliance after each use.



WARNING!

Risk of damage to the appliance.

- To prevent damage or discoloration to the enamel:
 - do not put ovenware or other objects in the appliance directly on the bottom.
 - do not put aluminium foil directly on the bottom of cavity of the appliance.
 - do not put water directly into the hot appliance.
 - do not keep moist dishes and food in the appliance after you finish the cooking.
 - be careful when you remove or install the accessories.
- Discoloration of the enamel or stainless steel has no effect on the performance of the appliance.
- Use a deep pan for moist cakes. Fruit juices cause stains that can be permanent.
- This appliance is for cooking purposes only. It must not be used for other purposes, for example room heating.
- Always cook with the oven door closed.
- If the appliance is installed behind a furniture panel (e.g. a door) make sure the door is never closed when the appliance is in operation. Heat and moisture can build up behind a closed furniture panel and cause

subsequent damage to the appliance, the housing unit or the floor. Do not close the furniture panel until the appliance has cooled down completely after use.

2.4 Care and cleaning



WARNING!

Risk of injury, fire, or damage to the appliance.

- Before maintenance, deactivate the appliance and disconnect the mains plug from the mains socket.
- Make sure the appliance is cold. There is the risk that the glass panels can break.
- Replace immediately the door glass panels when they are damaged. Contact the Authorised Service Centre.
- Be careful when you remove the door from the appliance. The door is heavy!
- Clean regularly the appliance to prevent the deterioration of the surface material.
- Clean the appliance with a moist soft cloth. Only use neutral detergents. Do not use any abrasive products, abrasive cleaning pads, solvents or metal objects.
- If you use an oven spray, follow the safety instruction on it's packaging.
- Do not clean the catalytic enamel (if applicable) with any kind of detergent.

2.5 Pyrolytic cleaning



WARNING!

Risk of Injury / Fires / Chemical Emissions (Fumes) in Pyrolytic Mode.

- Before carrying out a Pyrolytic self-cleaning function or the First Use please remove from the oven cavity:
 - any excess food residues, oil or grease spills / deposits.
 - any removable objects (including shelves, side rails etc., provided with the product) particularly any non-stick pots, pans, trays, utensils etc.

- Read carefully all the instructions for Pyrolytic cleaning.
- Keep children away from the appliance while the Pyrolytic cleaning is in operation. The appliance becomes very hot and hot air is released from the front cooling vents.
- Pyrolytic cleaning is a high temperature operation that can release fumes from cooking residues and construction materials, as such consumers are strongly advised to:
 - provide good ventilation during and after each Pyrolytic cleaning.
 - provide good ventilation during and after the first use at maximum temperature operation.
- Unlike all humans, some birds and reptiles can be extremely sensitive to potential fumes emitted during the cleaning process of all Pyrolytic Ovens.
 - Remove any pets (especially birds) from the vicinity of the appliance location during and after the Pyrolytic cleaning and first use maximum temperature operation to a well ventilated area.
- Small pets can also be highly sensitive to the localized temperature changes in the vicinity of all Pyrolytic Ovens when the Pyrolytic self cleaning program is in operation.
- Non-stick surfaces on pots, pans, trays, utensils etc., can be damaged by the high temperature Pyrolytic cleaning operation of all Pyrolytic Ovens and can be also a source for low level harmful fumes.
- Fumes released from all Pyrolytic Ovens / Cooking Residues as described are not harmful to humans, including infants or persons with medical conditions.

2.6 Internal light



WARNING!

Risk of electrical shock.

- The type of light bulb or halogen lamp used for this appliance is only for household appliances. Do not use it for house lighting.

- Before replacing the lamp, disconnect the appliance from the power supply.
- Only use lamps with the same specifications.
- Cut off the mains electrical cable close to the appliance and dispose of it.
- Remove the door catch to prevent children or pets from becoming trapped in the appliance.

2.7 Disposal



WARNING!

Risk of injury or suffocation.

- Disconnect the appliance from the mains supply.

2.8 Service

- To repair the appliance contact an Authorised Service Centre.
- Use original spare parts only.

3. PRODUCT DESCRIPTION

3.1 General overview

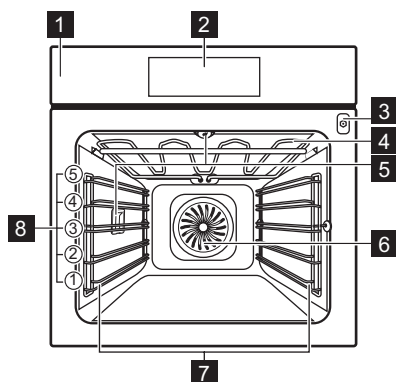

- 1 Control panel
- 2 Electronic programmer
- 3 Socket for the core temperature sensor
- 4 Heating element
- 5 Lamp
- 6 Fan
- 7 Shelf support, removable
- 8 Shelf positions

3.2 Accessories

Wire shelf

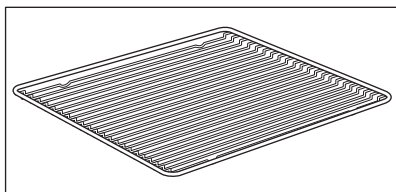

For cookware, cake tins, roasts.

Baking tray

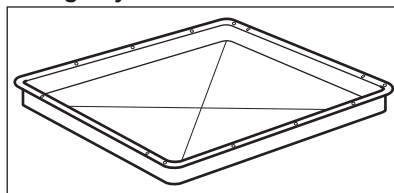

For cakes and biscuits.

Grill- / Roasting pan

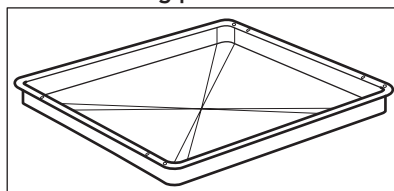

To bake and roast or as a pan to collect fat.

Trivet

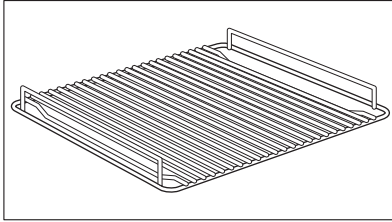

For roasting and grilling.

i Use the trivet only with the Grill- / Roasting pan.

To measure the temperature inside the food.

Telescopic runners

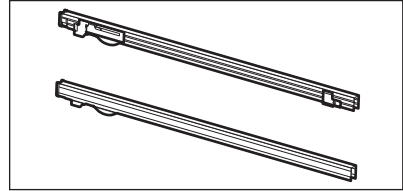

For shelves and trays.

Food Sensor

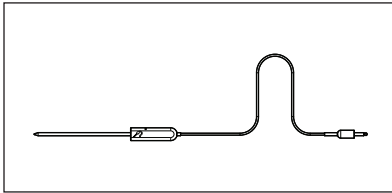





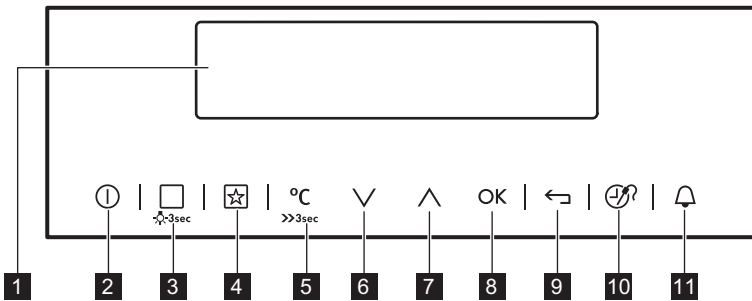



4. CONTROL PANEL

4.1 Electronic programmer



Use the sensor fields to operate the appliance.

Sensor field	Function	Comment
1	-	Display
2	ON / OFF	To turn on and off the appliance.





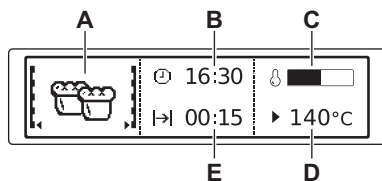





Sensor field	Function	Comment
3 	Heating Functions or Assisted Cooking	Press the sensor field to choose the menu: Assisted Cooking or Heating Functions. To turn on or turn off the light, press the field for 3 seconds. You can turn on the light also when the appliance is turned off.
4 	Favourites	To save and access your favourite programmes.
5 	Temperature selection	To set the temperature or show the current temperature in the appliance. Press the field for 3 seconds to turn on or turn off the function: Fast heat up.
6 	Down key	To move down in the menu.
7 	Up key	To move up in the menu.
8 	OK	To confirm the selection or setting.
9 	Back key	To go back one level in the menu. To show the main menu, press the field for 3 seconds.
10 	Time and additional functions	To set different functions. When a heating function operates, press the sensor field to set the timer or the functions: Function Lock, Favourites, Heat + Hold, Set + Go. You can also change the settings of the core temperature sensor.
11 	Minute Minder	To set the function: Minute Minder.

4.2 Display



- A. Heating function
- B. Time of day
- C. Heat-up indicator
- D. Temperature
- E. Duration time or end time of a function

Other indicators of the display:

Symbol		Function
	Minute Minder	The function operates.
	Time of day	The display shows the current time.
	Duration	The display shows the necessary time for cooking.
	End Time	The display shows when the cooking time is complete.
	Temperature	The display shows the temperature.
	Time Indication	The display shows how long the heating function operates. Press ∇ and ▲ at the same time to reset the time.
	Calculation	The appliance calculates the time for cooking.
	Heat-up Indicator	The display shows the temperature in the appliance.
	Fast Heat Up Indicator	The function is active. It decreases the heat up time.
	Weight Automatic	The display shows that the automatic weight system is active or that weight can be changed.
	Heat + Hold	The function is active.

5. BEFORE FIRST USE



WARNING!

Refer to Safety chapters.

5.1 Initial Cleaning

Remove all accessories and removable shelf supports from the oven.



Refer to "Care and cleaning" chapter.

Clean the oven and the accessories before first use.

Put the accessories and the removable shelf supports back to their initial position.

5.2 First Connection

When you connect the appliance to the mains or after the power cut, you have to set the language, the display contrast, the display brightness and the time of the day.

1. Press **▲** or **∇** to set the value.
2. Press **OK** to confirm.

6. DAILY USE



WARNING!
Refer to Safety chapters.

6.1 Navigating the menus

1. Activate the appliance.
2. Press ∇ or \blacktriangle to select the menu option.

3. Press **OK** to move to the submenu or accept the setting.



At each point you can go back to the main menu with \leftarrow .









6.2 The menus in overview

Main menu







Sym- bol	Menu item	Application
	Heating Functions	Contains a list of heating functions.
	Assisted Cooking	Contains a list of automatic programmes.
	Favourites	Contains a list of favourite cooking programmes created by the user.
	Pyrolysis	Pyrolytic cleaning.
	Basic Settings	Used to set the appliance configuration.
	Specials	Contains a list of additional heating functions.



Submenu for: Basic Settings

Sym- bol	Submenu	Description
	Set Time of Day	Sets the current time on the clock.
	Time Indication	When ON, the display shows the current time when you deactivate the appliance.
	Fast heat up	When ON, the function decreases the heat-up time.
	Set + Go	To set a function and activate it later with a press of any symbol on the control panel.
	Heat + Hold	Keeps the prepared food warm for 30 minutes after a cooking cycle finished.
	Time Extension	Activates and deactivates the time extension function.
	Display Contrast	Adjusts the display contrast by degrees.

Symbol	Submenu	Description
	Display Brightness	Adjusts the display brightness by degrees.
	Set Language	Sets the language for the display.
	Buzzer Volume	Adjusts the volume of press-tones and signals by degrees.
	Key Tones	Activates and deactivates the tone of the touch fields. It is not possible to deactivate the tone of the ON / OFF touch field.
	Alarm/Error Tones	Activates and deactivates the alarm tones.
	Cleaning Reminder	Reminds you when to clean the appliance.
	DEMO mode	Activation / deactivation code: 2468
	Service	Shows the software version and configuration.
	Factory Settings	Resets all settings to factory settings.











6.3 Heating Functions

Heating function	Application
 True Fan Cooking	To bake on up to three shelf positions at the same time and to dry food. Set the temperature 20 - 40 °C lower than for the function: Conventional Cooking.
 Pizza Setting	To bake food on one shelf position for a more intensive browning and a crispy bottom. Set the temperature 20 - 40 °C lower than for the function: Conventional Cooking.
 Conventional Cooking (Top / Bottom Heat)	To bake and roast food on one shelf position.
 Frozen Foods	To make convenience food like e.g. french fries, potato wedges or spring rolls crispy.
 Grilling	To grill flat food and to toast bread.
 Turbo Grilling	To bake cakes with crispy bottom and to preserve food.

Heating function	Application
 Bottom Heat	To bake cakes with crispy bottom and to preserve food.
 Moist Fan Baking	To bake breads, cakes and cookies. To save energy during cooking. This function must be used in accordance with the Moist Fan Baking table in order to achieve the desired cooking result. To get more information about the recommended settings, refer to the Hints and Tips chapter, Moist Fan Baking table. This function was used to define the energy efficiency class acc. to EN 60350-1.

 The lamp may automatically deactivate at a temperature below 60 °C during some oven functions.

6.4 Specials

Heating function	Application
  Keep Warm	To keep food warm.
 Plate Warming	To preheat plates for serving.
 Preserving	To make vegetable preserves such as pickles.
 Drying	To dry sliced fruit (e.g. apples, plums, peaches) and vegetables (e.g. tomatoes, zucchini, mushrooms).
 Dough Proving	For controlled rising of yeast dough before baking.
 Slow Cooking	To prepare tender, succulent roasts.
  Bread Baking	To bake bread.
 Defrost	This function can be used for defrosting frozen foods, such as vegetables and fruits. The defrosting time depends on the amount and size of the frozen food.

6.5 Activating a heating function

1. Activate the appliance.
2. Select the menu: Heating Functions.
3. Press **OK** to confirm.
4. Select a heating function.
5. Press **OK** to confirm.
6. Set the temperature.
7. Press **OK** to confirm.

6.6 Heat-up indicator

When you activate a heating function, the bar on the display comes on. The bar shows that the temperature increases. When temperature is reached the buzzer sounds 3 times and the bar flashes and then disappears.

6.7 Fast Heat Up Indicator

This function decreases the heat-up time.

 Do not put food in the oven when the Fast heat up function operates.







To activate the function, hold $\gg_{\text{min}}^{\circ\text{C}}$ for 3 seconds. The heat-up indicator alternates.

6.8 Residual heat

When you turn off the oven, the display shows the residual heat. You can use the heat to keep the food warm.

7. CLOCK FUNCTIONS

7.1 Clock functions table

Clock function		Application
	Minute Minder	To set a countdown (max. 2 h 30 min). This function has no effect on the operation of the appliance. You can also activate it when the appliance is deactivated. Use  to activate the function. Press  or  to set the minutes and OK to start.
	Duration	To set the length of an operation (max. 23 h 59 min).
	End Time	To set the switch-off time for a heating function (max. 23 h 59 min).



If you set the time for a clock function, the time starts to count down after 5 seconds.



If you use the clock functions: Duration, End Time, the appliance deactivates the heating elements after 90 % of the set time. The appliance uses the residual heat to continue the cooking process until the time ends (3 - 20 minutes).

7.2 Setting the clock functions

 Before you use the functions: Duration, End Time, you must set a heating function and temperature first. The appliance deactivates automatically. You can use the functions: Duration and End Time at the same time if you want to automatically activate and deactivate the appliance on a given time later. The functions: Duration and End Time do not work when you use the core temperature sensor.

1. Set a heating function.
2. Press  again and again until the display shows the necessary clock function and the related symbol.
3. Press  or  to set the necessary time.
4. Press **OK** to confirm.
When the time ends, an acoustic signal sounds. The appliance deactivates. The display shows a message.
5. Press any symbol to stop the signal.

7.3 Heat + Hold

Conditions for the function:

- The set temperature is more than 80 °C.
- The function: Duration is set.

The function: Heat + Hold keeps prepared food warm at 80 °C for 30 minutes. It activates after the baking or roasting procedure ends.



You can activate or deactivate the function in the menu: Basic Settings.

1. Activate the appliance.
2. Select the heating function.
3. Set the temperature above 80 °C.
4. Press  again and again until the display shows: Heat + Hold.
5. Press **OK** to confirm.
When the function ends, an acoustic signal sounds.
The function stays on if you change the heating functions.

7.4 Time Extension

The function: Time Extension makes the heating function continue after the end of Duration.

 Applicable to all heating functions with Duration or Weight Automatic.
Not applicable to heating functions with the core temperature sensor.

1. When the cooking time ends, an acoustic signal sounds. Press any symbol.
The display shows the message.
2. Press  to activate or  to cancel.
3. Set the length of the function.
4. Press **OK**.

8. AUTOMATIC PROGRAMMES



WARNING!
Refer to Safety chapters.

8.1 Recipes online

 You can find the recipes for the automatic programmes specified for this appliance on our website. To find the proper Recipe Book check the PNC number on the rating plate on the front frame of the appliance cavity.

8.2 Assisted Cooking with Recipe Automatic

This appliance has a set of recipes you can use. The recipes are fixed and you cannot change them.

1. Activate the appliance.
2. Select the menu: Assisted Cooking. Press **OK** to confirm.
3. Select the category and dish. Press **OK** to confirm.
4. Select a recipe. Press **OK** to confirm.



When you use the function: Manual, the appliance uses the automatic settings. You can change them as with other functions.

8.3 Assisted Cooking with Weight Automatic

This function automatically calculates the roasting time. To use it, it is necessary to input the food weight.

1. Activate the appliance.
2. Select the menu: Assisted Cooking. Press **OK** to confirm.
3. Select the category and dish. Press **OK** to confirm.
4. Select the function: Weight Automatic. Press **OK** to confirm.
5. Touch \wedge or \vee to set the food weight. Press **OK** to confirm. The automatic programme starts.
6. You can change the weight at any time. Press \wedge or \vee to change the weight.
7. When the time ends, an acoustic signal sounds. Press any symbol to deactivate the signal.



With some programmes turn over the food after 30 minutes. The display shows a reminder.

9. USING THE ACCESSORIES



WARNING!

Refer to Safety chapters.

9.1 Food sensor

The food sensor measures temperature inside the food. When the food is at the set temperature, the appliance deactivates.

There are two temperatures to be set:

- the oven temperature (minimum 120 °C),
- the food core temperature.



CAUTION!

Use only the food sensor supplied and the original replacement parts.

Directions for the best results:

- Ingredients should be at room temperature.
- Food sensor cannot be used for liquid dishes.

- During cooking the food sensor must remain in the dish and the plug in the socket.
- Use recommended food core temperature settings. Refer to "Hints and tips" chapter.



The appliance calculates an approximate end of cooking time. It depends on the quantity of food, the set oven function and temperature.

Food categories: meat, poultry and fish

1. Activate the appliance.
2. Insert the tip of the food sensor into the centre of meat or fish, in the thickest part if possible. Make sure that at least 3/4 of the food sensor is inside of the dish.
3. Put the plug of the food sensor into the socket located in the front frame of the appliance.

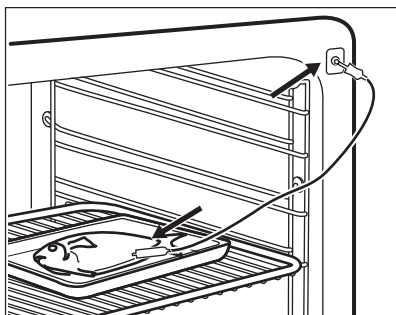
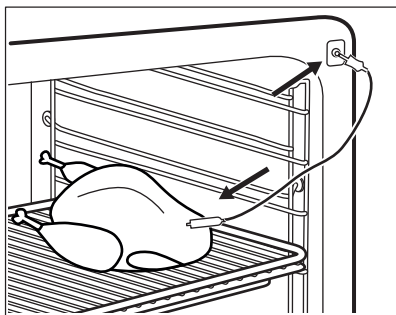

The display shows the food sensor symbol.

4. Press \wedge or \vee in less than 5 seconds to set the food core temperature.
5. Set a heating function and, if necessary, the oven temperature.
6. To change the food core temperature, press Ⓜ .

When the dish reaches the set temperature, an acoustic signal sounds. The appliance deactivates automatically.

7. Touch any symbol to stop the signal.
8. Remove the food sensor plug from the socket and remove the dish from the appliance.



WARNING!

There is a risk of burns as the food sensor becomes hot. Be careful when you unplug it and remove it from the food.

Food category: casserole

1. Activate the appliance.
2. Place half of the ingredients in a baking dish.

3. Insert the tip of the food sensor exactly in the centre of the casserole. The food sensor should be stabilized in one place during baking. Use a solid ingredient to achieve that. Use the rim of the baking dish to support the silicone handle of the food sensor. The tip of the food sensor should not touch the bottom of a baking dish.

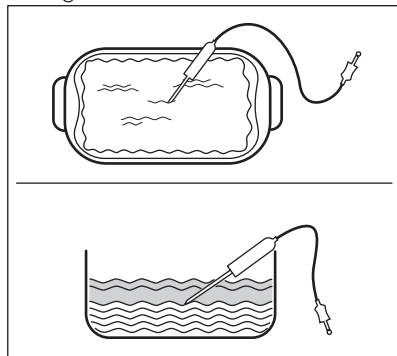

4. Cover the food sensor with the remaining ingredients.
5. Put the plug of the food sensor into the socket located in the front frame of the appliance.

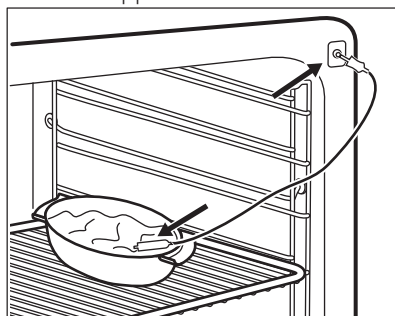

The display shows the food sensor symbol.

6. Press \wedge or \vee in less than 5 seconds to set the food core temperature.
7. Set a heating function and, if necessary, the oven temperature.
8. To change the food core temperature, press Ⓜ .

When the dish is at the set temperature, an acoustic signal sounds. The appliance deactivates automatically.

9. Touch any symbol to stop the signal.
10. Remove the food sensor plug from the socket and remove the dish from the appliance.



WARNING!

There is a risk of burns as the food sensor becomes hot. Be careful when you unplug it and remove it from the food.

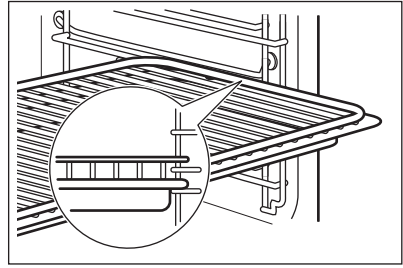

9.2 Inserting the accessories

Wire shelf:

Push the shelf between the guide bars of the shelf support and make sure that the feet point down.

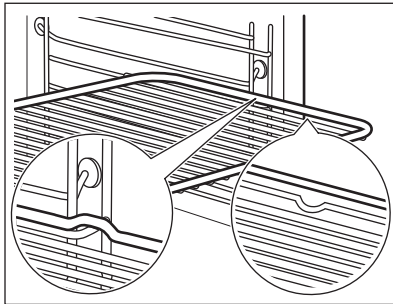

Baking tray / Deep pan:

Push the baking tray / deep pan between the guide bars of the shelf support.

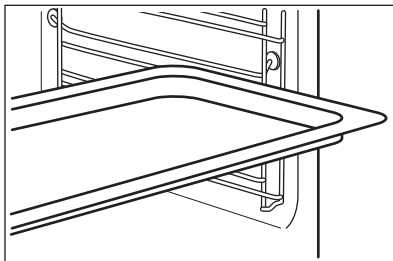

Wire shelf and baking tray / deep pan together:

Push the baking tray / deep pan between the guide bars of the shelf support and the wire shelf on the guide bars above.



Small indentation at the top increase safety. The indentations are also anti-tip devices. The high rim around the shelf prevents cookware from slipping of the shelf.

9.3 Telescopic runners - inserting the accessories

With the telescopic runners you can put in and remove the shelves more easily.



CAUTION!

Do not clean the telescopic runners in the dishwasher. Do not lubricate the telescopic runners.



CAUTION!

Make sure you push back the telescopic runners fully in the oven before you close the oven door.

Wire shelf:

Put the wire shelf on the telescopic runners so that the feet point downwards.



The high rim around the wire shelf is a special device to prevent the cookware from slipping.

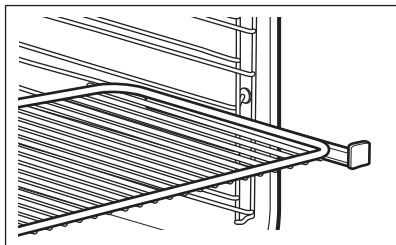

Deep pan:

Put the deep pan on the telescopic runners.

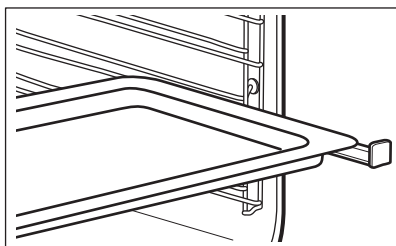

Wire shelf and deep pan together:

Place the wire shelf and the deep pan together on the telescopic runner.

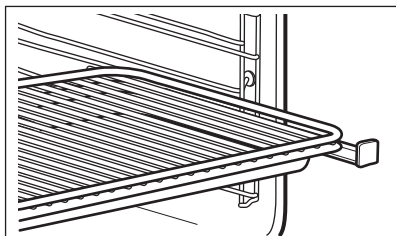

9.4 Trivet and Grill- / Roasting pan



WARNING!

Be careful when you remove the accessories from a hot oven. There is a risk of burns.

You can use the trivet to roast larger pieces of meat or poultry on one shelf position.

1. Put the trivet into the deep pan so that the supports of the wire shelf point up.

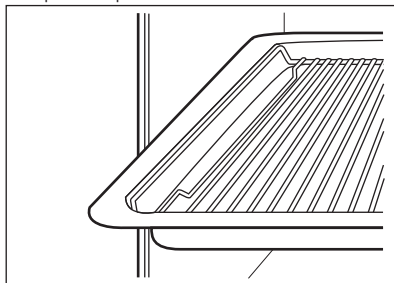

2. Put the deep pan into the oven on the necessary shelf position. You can use the trivet to grill flat dishes in large quantities and to toast.

1. Put the trivet into the deep pan so that the supports of the wire shelf point down.

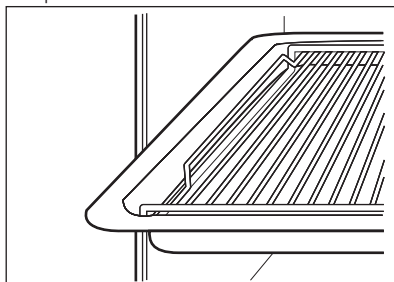

2. Put the deep pan into the oven on the necessary shelf position.

10. ADDITIONAL FUNCTIONS





10.1 Favourites

You can save your favourite settings, such as duration, temperature or heating function. They are available in the menu:

Favourites. You can save 20 programmes.

Saving a programme

1. Activate the appliance.

2. Set a heating function or an automatic programme.
3. Touch  again and again until the display shows: SAVE.
4. Press **OK** to confirm.
The display shows the first free memory position.
5. Press **OK** to confirm.
6. Enter the name of the programme.
The first letter flashes.
7. Touch  or  to change the letter.
8. Press **OK**.
The next letter flashes.
9. Do step 7 again as necessary.
10. Press and hold **OK** to save.
You can overwrite a memory position. When the display shows the first free memory position, touch  or  and press **OK** to overwrite an existing programme.

You can change the name of a programme in the menu: Edit Programme Name.

Activating the programme

1. Activate the appliance.
2. Select the menu: Favourites.
3. Press **OK** to confirm.
4. Select your favourite programme name.
5. Press **OK** to confirm.



Press  to go directly to menu: Favourites. You can also use it when the appliance is deactivated.

10.2 Using the Child Lock

When the Child Lock is on, the appliance cannot be activated accidentally.

-  If the Pyrolysis function operates, the door locks automatically. A message comes on in the display when you touch any symbol.

1. Touch  to activate the display.



2. Touch  and  at the same time until the display shows a message. To deactivate the Child Lock function repeat step 2.

10.3 Function Lock

This function prevents an accidental change of the heating function. You can activate it only when the appliance operates.

1. Activate the appliance.
2. Set a heating function or setting.
3. Press  again and again until the display shows: Function Lock.
4. Press **OK** to confirm.



-  If the Pyrolysis function operates, the door is locked and the symbol of a key comes on in the display.

To deactivate the function, press . The display shows a message. Press  again and then **OK** to confirm.

-  When you deactivate the appliance, the function also deactivates.

10.4 Set + Go

The function lets you set a heating function (or a programme) and use it later with one press of any symbol.

1. Activate the appliance.
2. Set a heating function.
3. Press  again and again until the display shows: Duration.
4. Set the time.
5. Press  again and again until the display shows: Set + Go.
6. Press **OK** to confirm.

Press any symbol (except for ) to start the function: Set + Go. The set heating function starts.

When the heating function ends, an acoustic signal sounds.



- Function Lock is on when the heating function operates.
- The menu: Basic Settings lets you activate and deactivate the function: Set + Go.

10.5 Automatic Switch-off

For safety reasons the appliance turns off automatically after some time if a heating function operates and you do not change any settings.

Temperature (°C)	Switch-off time (h)
30 - 115	12.5
120 - 195	8.5
200 - 245	5.5
250 - maximum	1.5



The Automatic switch-off does not work with the functions: Light, Food Sensor, Duration, End Time.

10.6 Brightness of the display

There are two modes of display brightness:

- Night brightness - when the appliance is deactivated, the brightness of the display is lower between 10 PM and 6 AM.
- Day brightness:
 - when the appliance is activated.
 - if you touch a symbol during the night brightness (apart from ON / OFF), the display goes back to the day brightness mode for the next 10 seconds.
 - if the appliance is deactivated and you set the function: Minute Minder. When the function ends, the display goes back to the night brightness.

10.7 Cooling fan

When the oven operates, the cooling fan turns on automatically to keep the surfaces of the oven cool. If you turn off the oven, the cooling fan can continue to operate until the oven cools down.

11. HINTS AND TIPS



WARNING!
Refer to Safety chapters.



The temperature and baking times in the tables are guidelines only. They depend on the recipes and the quality and quantity of the ingredients used.

11.1 Inner side of the door

In some models, on the inner side of the door you can find:

- the numbers of the shelf positions.
- information about the heating functions, recommended shelf positions and temperatures for typical dishes.

11.2 Advice for special heating functions of the oven

Keep Warm

Use this function if you want to keep food warm.

The temperature regulates itself automatically to 80 °C.

Plate Warming

For warming plates and dishes.

Distribute plates and dishes evenly on the wire shelf. Move stacks around after half of the warming time (swap top and bottom).

The automatic temperature is 70 °C.

Recommended shelf position: 3.

Dough Proving

You can use this automatic function with any recipe for yeast dough you like. It gives you a good atmosphere for rising. Put the dough into a dish that is big enough for rising and cover it with a wet towel or plastic foil. Insert a wire shelf on the first shelf position and put the dish in. Close the door and set the function: Dough Proving. Set the necessary time.

11.3 Baking

- Your oven may bake or roast differently to the oven you had before. Adapt your usual settings such as temperature, cooking time
- Use the lower temperature the first time.
- If you cannot find the settings for a special recipe, look for the similar one.
- You can extend baking times by 10 – 15 minutes if you bake cakes on more than one shelf position.
- Cakes and pastries at different heights do not always brown equally at first. If this occurs, do not change the temperature setting. The differences equalize during the baking procedure.
- Trays in the oven can twist during baking. When the trays become cold again, the distortions disappear.

11.4 Tips on baking

Baking results	Possible cause	Remedy
The bottom of the cake is not browned sufficiently.	The shelf position is incorrect.	Put the cake on a lower shelf.
The cake sinks and becomes soggy, lumpy or streaky.	The oven temperature is too high.	The next time you bake, set a slightly lower oven temperature.
The cake sinks and becomes soggy, lumpy or streaky.	The baking time is too short.	Set a longer baking time. You cannot decrease baking times by setting higher temperatures.
The cake sinks and becomes soggy, lumpy or streaky.	There is too much liquid in the mixture.	Use less liquid. Be careful with mixing times, especially if you use a mixing machine.
The cake is too dry.	The oven temperature is too low.	The next time you bake, set a higher oven temperature.
The cake is too dry.	The baking time is too long.	The next time you bake, set a shorter baking time.
The cake browns unevenly.	The oven temperature is too high and the baking time is too short.	Set a lower oven temperature and a longer baking time.
The cake browns unevenly.	The mixture is unevenly distributed.	Spread the mixture evenly on the baking tray.
The cake is not ready in the baking time given.	The oven temperature is too low.	The next time you bake, set a slightly higher oven temperature.

11.5 Baking on one level:

Baking in tins

Food	Function	Temperature (°C)	Time (min)	Shelf position
Ring cake / Brioche	True Fan Cooking	150 - 160	50 - 70	1
Madeira cake / Fruit cakes	True Fan Cooking	140 - 160	70 - 90	1
Fatless sponge cake / Fatless sponge cake	True Fan Cooking	140 - 150	35 - 50	2
Fatless sponge cake / Fatless sponge cake	Conventional Cooking	160	35 - 50	2
Flan base - short pastry	True Fan Cooking	170 - 180 ¹⁾	10 - 25	2
Flan base - sponge mixture	True Fan Cooking	150 - 170	20 - 25	2
Apple pie / Apple pie (2 tins Ø20 cm, diagonally off set)	True Fan Cooking	160	60 - 90	2
Apple pie / Apple pie (2 tins Ø20 cm, diagonally off set)	Conventional Cooking	180	70 - 90	1
Cheesecake	Conventional Cooking	170 - 190	60 - 90	1

¹⁾ Preheat the oven.

Cakes / pastries / breads on baking trays

Food	Function	Temperature (°C)	Time (min)	Shelf position
Plaited bread / Bread crown	Conventional Cooking	170 - 190	30 - 40	3
Christmas stollen	Conventional Cooking	160 - 180 ¹⁾	50 - 70	2

Food	Function	Temperature (°C)	Time (min)	Shelf position
Bread (rye bread): 1. First part of baking procedure. 2. Second part of baking procedure.	Conventional Cooking	1. 230 ¹⁾ 2. 160 - 180	1. 20 2. 30 - 60	1
Cream puffs / Eclairs	Conventional Cooking	190 - 210 ¹⁾	20 - 35	3
Swiss roll	Conventional Cooking	180 - 200 ¹⁾	10 - 20	3
Cake with crumble topping (dry)	True Fan Cooking	150 - 160	20 - 40	3
Buttered almond cake / Sugar cakes	Conventional Cooking	190 - 210 ¹⁾	20 - 30	3
Fruit flans (made with yeast dough / sponge mixture) ²⁾	True Fan Cooking	150	35 - 55	3
Fruit flans (made with yeast dough / sponge mixture) ²⁾	Conventional Cooking	170	35 - 55	3
Fruit flans made with short pastry	True Fan Cooking	160 - 170	40 - 80	3
Yeast cakes with delicate toppings (e.g. quark, cream, custard)	Conventional Cooking	160 - 180 ¹⁾	40 - 80	3

1) Preheat the oven.

2) Use a deep pan.

Biscuits

Food	Function	Temperature (°C)	Time (min)	Shelf position
Short pastry biscuits	True Fan Cooking	150 - 160	10 - 20	3

Food	Function	Temperature (°C)	Time (min)	Shelf position
Short bread / Short bread / Pastry stripes	True Fan Cook- ing	140	20 - 35	3
Short bread / Short bread / Pastry stripes	Conventional Cooking	160 ¹⁾	20 - 30	3
Biscuits made with sponge mixture	True Fan Cook- ing	150 - 160	15 - 20	3
Pastries made with egg white / Meringues	True Fan Cook- ing	80 - 100	120 - 150	3
Macaroons	True Fan Cook- ing	100 - 120	30 - 50	3
Biscuits made with yeast dough	True Fan Cook- ing	150 - 160	20 - 40	3
Puff pastries	True Fan Cook- ing	170 - 180 ¹⁾	20 - 30	3
Rolls	True Fan Cook- ing	160 ¹⁾	10 - 25	3
Rolls	Conventional Cooking	190 - 210 ¹⁾	10 - 25	3
Small cakes / Small cakes (20 per tray)	True Fan Cook- ing	150 ¹⁾	20 - 35	3
Small cakes / Small cakes (20 per tray)	Conventional Cooking	170 ¹⁾	20 - 30	3

¹⁾ Preheat the oven.

11.6 Bakes and gratins

Food	Function	Temperature (°C)	Time (min)	Shelf position
Pasta bake	Conventional Cooking	180 - 200	45 - 60	1
Lasagne	Conventional Cooking	180 - 200	25 - 40	1

Food	Function	Temperature (°C)	Time (min)	Shelf position
Vegetables au gratin ¹⁾	Turbo Grilling	160 - 170	15 - 30	1
Baguettes topped with melted cheese	True Fan Cooking	160 - 170	15 - 30	1
Sweet bakes	Conventional Cooking	180 - 200	40 - 60	1
Fish bakes	Conventional Cooking	180 - 200	30 - 60	1
Stuffed vegetables	True Fan Cooking	160 - 170	30 - 60	1

¹⁾ Preheat the oven.

11.7 Moist Fan Baking

Food	Temperature (°C)	Time (min)	Shelf position
Pasta gratin	200 - 220	45 - 55	3
Potato gratin	180 - 200	70 - 85	3
Moussaka	170 - 190	70 - 95	3
Lasagne	180 - 200	75 - 90	3
Cannelloni	180 - 200	70 - 85	3
Bread pudding	190 - 200	55 - 70	3
Rice pudding	170 - 190	45 - 60	3
Apple cake, made with sponge mixture (round cake tin)	160 - 170	70 - 80	3
White bread	190 - 200	55 - 70	3

11.8 Multilevel Baking

Use the function: True Fan Cooking.

Cakes / pastries / breads on baking trays

Food	Temperature (°C)	Time (min)	Shelf position	
			2 positions	3 positions
Cream puffs / Eclairs	160 - 180 ¹⁾	25 - 45	1 / 4	-
Dry streusel cake	150 - 160	30 - 45	1 / 4	-

¹⁾ Preheat the oven.

Biscuits / small cakes / small cakes / pastries / rolls

Food	Temperature (°C)	Time (min)	Shelf position	
			2 positions	3 positions
Short pastry biscuits	150 - 160	20 - 40	1 / 4	1 / 3 / 5
Short bread / Short bread / Pastry Stripes	140	25 - 45	1 / 4	1 / 3 / 5
Biscuits made with sponge mixture	160 - 170	25 - 40	1 / 4	-
Biscuits made with egg white, meringues	80 - 100	130 - 170	1 / 4	-
Macaroons	100 - 120	40 - 80	1 / 4	-
Biscuits made with yeast dough	160 - 170	30 - 60	1 / 4	-
Puff pastries	170 - 180 ¹⁾	30 - 50	1 / 4	-
Rolls	180	20 - 30	1 / 4	-
Small cakes / Small cakes (20 per tray)	150 ¹⁾	23 - 40	1 / 4	-

¹⁾ Preheat the oven.

11.9 Pizza Setting

Food	Temperature (°C)	Time (min)	Shelf position
Pizza (thin crust)	200 - 230 ¹⁾²⁾	15 - 20	2
Pizza (with a lot of topping)	180 - 200	20 - 30	2

Food	Temperature (°C)	Time (min)	Shelf position
Tarts	180 - 200	40 - 55	1
Spinach flan	160 - 180	45 - 60	1
Quiche Lorraine	170 - 190	45 - 55	1
Swiss Flan	170 - 190	45 - 55	1
Apple cake, covered	150 - 170	50 - 60	1
Vegetable pie	160 - 180	50 - 60	1
Unleavened bread	230 - 250 ¹⁾	10 - 20	2
Puff pastry flan	160 - 180 ¹⁾	45 - 55	2
Flammekuchen (Piz-za-like dish from Al-sace)	230 - 250 ¹⁾	12 - 20	2
Piroggen (Russian version of calzone)	180 - 200 ¹⁾	15 - 25	2

1) Preheat the oven.

2) Use a deep pan.

11.10 Roasting

- Use heat-resistant ovenware to roast. Refer to the instructions of the ovenware manufacturer.
- You can roast large roasting joints directly in the deep pan or on the wire shelf above the deep pan.
- Put some liquid in the deep pan to prevent the meat juices or fat from burning on it's surface.
- All types of meat that can be browned or have crackling can be roasted in the roasting tin without the lid.
- If necessary, turn the roast after 1/2 to 2/3 of the cooking time.
- To keep meat more succulent:
 - roast lean meat in the roasting tin with the lid or use roasting bag.
 - roast meat and fish in pieces weighting minimum 1 kg.
 - baste large roasts and poultry with their juices several times during roasting.

11.11 Roasting tables

Beef

Food	Quantity	Function	Temperature (°C)	Time (min)	Shelf position
Pot roast	1 - 1.5 kg	Conventional Cooking	230	120 - 150	1
Roast beef or fillet: rare	per cm of thickness	Turbo Grilling	190 - 200 ¹⁾	5 - 6	1

Food	Quantity	Function	Temperature (°C)	Time (min)	Shelf position
Roast beef or fillet: medium	per cm of thickness	Turbo Grilling	180 - 190 ¹⁾	6 - 8	1
Roast beef or fillet: well done	per cm of thickness	Turbo Grilling	170 - 180 ¹⁾	8 - 10	1

¹⁾ Preheat the oven.

Pork

Food	Quantity	Function	Temperature (°C)	Time (min)	Shelf position
Shoulder / Neck / Ham joint	1 - 1.5 kg	Turbo Grilling	160 - 180	90 - 120	1
Chop / Spare rib	1 - 1.5 kg	Turbo Grilling	170 - 180	60 - 90	1
Meatloaf	750 g - 1 kg	Turbo Grilling	160 - 170	50 - 60	1
Pork knuckle (precooked)	750 g - 1 kg	Turbo Grilling	150 - 170	90 - 120	1

Veal

Food	Quantity (kg)	Function	Temperature (°C)	Time (min)	Shelf position
Roast veal	1	Turbo Grilling	160 - 180	90 - 120	1
Knuckle of veal	1.5 - 2	Turbo Grilling	160 - 180	120 - 150	1

Lamb

Food	Quantity (kg)	Function	Temperature (°C)	Time (min)	Shelf position
Leg of lamb / Roast lamb	1 - 1.5	Turbo Grilling	150 - 170	100 - 120	1
Saddle of lamb	1 - 1.5	Turbo Grilling	160 - 180	40 - 60	1

Game

Food	Quantity	Function	Temperature (°C)	Time (min)	Shelf position
Saddle / Leg of hare	up to 1 kg	Conventional Cooking	230 ¹⁾	30 - 40	1

Food	Quantity	Function	Temperature (°C)	Time (min)	Shelf position
Saddle of venison	1.5 - 2 kg	Conventional Cooking	210 - 220	35 - 40	1
Haunch of venison	1.5 - 2 kg	Conventional Cooking	180 - 200	60 - 90	1

1) Preheat the oven.

Poultry

Food	Quantity	Function	Temperature (°C)	Time (min)	Shelf position
Poultry portions	200 - 250 g each	Turbo Grilling	200 - 220	30 - 50	1
Half chicken	400 - 500 g each	Turbo Grilling	190 - 210	35 - 50	1
Chicken, poulard	1 - 1.5 kg	Turbo Grilling	190 - 210	50 - 70	1
Duck	1.5 - 2 kg	Turbo Grilling	180 - 200	80 - 100	1
Goose	3.5 - 5 kg	Turbo Grilling	160 - 180	120 - 180	1
Turkey	2.5 - 3.5 kg	Turbo Grilling	160 - 180	120 - 150	1
Turkey	4 - 6 kg	Turbo Grilling	140 - 160	150 - 240	1

Fish (steamed)

Food	Quantity (kg)	Function	Temperature (°C)	Time (min)	Shelf position
Whole fish	1 - 1.5	Conventional Cooking	210 - 220	40 - 60	1

11.12 Grilling

- Always grill with the maximum temperature setting.
- Set the shelf into the shelf position as recommended in the grilling table.
- Always set the pan to collect the fat into the first shelf position.

- Grill only flat pieces of meat or fish.
- Always preheat the empty oven with the grill functions for 5 minutes.



CAUTION!

Always grill with the oven door closed.

Grilling

Food	Temperature (°C)	Time (min)		Shelf position
		1st side	2nd side	
Roast beef	210 - 230	30 - 40	30 - 40	2
Filet of beef	230	20 - 30	20 - 30	3
Back of pork	210 - 230	30 - 40	30 - 40	2
Back of veal	210 - 230	30 - 40	30 - 40	2
Back of lamb	210 - 230	25 - 35	20 - 25	3
Whole Fish, 500 - 1000 g	210 - 230	15 - 30	15 - 30	3 / 4

Fast Grilling

Food	Time (min)		Shelf position
	1st side	2nd side	
Burgers / Burgers	8 - 10	6 - 8	4
Pork fillet	10 - 12	6 - 10	4
Sausages	10 - 12	6 - 8	4
Fillet / Veal steaks	7 - 10	6 - 8	4
Toast / Toast	1 - 3	1 - 3	5
Toast with topping	6 - 8	-	4

11.13 Frozen Foods

Food	Temperature (°C)	Time (min)	Shelf position
Pizza, frozen	200 - 220	15 - 25	2
Pizza American, frozen	190 - 210	20 - 25	2
Pizza, chilled	210 - 230	13 - 25	2
Pizza Snacks, frozen	180 - 200	15 - 30	2
French Fries, thin	200 - 220	20 - 30	3
French Fries, thick	200 - 220	25 - 35	3
Wedges / Croquettes	220 - 230	20 - 35	3
Hash Browns	210 - 230	20 - 30	3
Lasagne / Cannelloni, fresh	170 - 190	35 - 45	2

Food	Temperature (°C)	Time (min)	Shelf position
Lasagne / Cannelloni, frozen	160 - 180	40 - 60	2
Oven baked cheese	170 - 190	20 - 30	3
Chicken Wings	190 - 210	20 - 30	2

Frozen ready meals

Food	Function	Temperature (°C)	Time (min)	Shelf position
Frozen pizza	Conventional Cooking	as per manufacturer's instructions	as per manufacturer's instructions	3
French fries ¹⁾ (300 - 600 g)	Conventional Cooking or Turbo Grilling	200 - 220	as per manufacturer's instructions	3
Baguettes	Conventional Cooking	as per manufacturer's instructions	as per manufacturer's instructions	3
Fruit flans	Conventional Cooking	as per manufacturer's instructions	as per manufacturer's instructions	3

¹⁾ Turn the French fries 2 or 3 times during cooking.

11.14 Slow Cooking

Use this function to prepare lean, tender pieces of meat and fish with core temperatures no more than 65 °C. This function is not applicable to such recipes as pot roast or fatty roast pork. You can use the core temperature sensor to guarantee that the meat has the correct core temperature (see the table for the core temperature sensor).

In the first 10 minutes you can set an oven temperature between 80 °C and 150 °C. The default is 90 °C. After the temperature is set, the oven continues to cook at 80 °C. Do not use this function for poultry.



Always cook without a lid when you use this function.

1. Sear the meat in a pan on the hob on a very high setting for 1 - 2 minutes on each side.
2. Put the meat together with the hot roasting pan in the oven and on the wire shelf.
3. Put the core temperature sensor into the meat.
4. Select the function: Slow Cooking and set the correct end core temperature.

Food	Quantity (kg)	Temperature (°C)	Time (min)	Shelf position
Roast beef	1 - 1.5	120	120 - 150	1

Food	Quantity (kg)	Temperature (°C)	Time (min)	Shelf position
Fillet of beef	1 - 1.5	120	90 - 150	3
Roast veal	1 - 1.5	120	120 - 150	1
Steaks	0.2 - 0.3	120	20 - 40	3

11.15 Defrost

- Remove the food packaging and put the food on a plate.
- Use the first shelf position from the bottom.
- Do not cover the food with a bowl or a plate, as this can extend the defrost time.

Food	Quantity	Defrosting time (min)	Further defrosting time (min)	Comments
Chicken	1 kg	100 - 140	20 - 30	Put the chicken on an upturned saucer in a big plate. Turn halfway through.
Meat	1 kg	100 - 140	20 - 30	Turn halfway through.
Meat	500 g	90 - 120	20 - 30	Turn halfway through.
Trout	150 g	25 - 35	10 - 15	-
Strawberries	300 g	30 - 40	10 - 20	-
Butter	250 g	30 - 40	10 - 15	-
Cream	2 x 200 g	80 - 100	10 - 15	Whip the cream when still slightly frozen in places.
Gateau	1.4 kg	60	60	-

11.16 Preserving

- Use only preserve jars of the same dimensions available on the market.
- Do not use jars with twist-off and bayonet type lids or metal tins.
- Use the first shelf from the bottom for this function.
- Put no more than six one-litre preserve jars on the baking tray.
- Fill the jars equally and close with a clamp.
- The jars cannot touch each other.
- Put approximately 1/2 litre of water into the baking tray to give sufficient moisture in the oven.
- When the liquid in the jars starts to simmer (after approximately 35 - 60 minutes with one-litre jars), stop the oven or decrease the temperature to 100 °C (see the table).

Soft fruit

Food	Temperature (°C)	Cooking time until simmering (min)	Continue to cook at 100 °C (min)
Strawberries / Blueberries / Raspberries / Ripe gooseberries	160 - 170	35 - 45	-

Stone fruit

Food	Temperature (°C)	Cooking time until simmering (min)	Continue to cook at 100 °C (min)
Pears / Quinces / Plums	160 - 170	35 - 45	10 - 15

Vegetables

Food	Temperature (°C)	Cooking time until simmering (min)	Continue to cook at 100 °C (min)
Carrots ¹⁾	160 - 170	50 - 60	5 - 10
Cucumbers	160 - 170	50 - 60	-
Mixed pickles	160 - 170	50 - 60	5 - 10
Kohlrabi / Peas / Asparagus	160 - 170	50 - 60	15 - 20

¹⁾ Leave standing in the oven after it is deactivated.

11.17 Drying

- Cover trays with grease proof paper or baking parchment.
- For a better result, stop the oven halfway through the drying time, open

the door and let it cool down for one night to complete the drying.

Vegetables

Food	Temperature (°C)	Time (h)	Shelf position	
			1 position	2 positions
Beans	60 - 70	6 - 8	3	1 / 4
Peppers	60 - 70	5 - 6	3	1 / 4
Vegetables for sour	60 - 70	5 - 6	3	1 / 4
Mushrooms	50 - 60	6 - 8	3	1 / 4
Herbs	40 - 50	2 - 3	3	1 / 4

Fruit

Food	Temperature (°C)	Time (h)	Shelf position	
			1 position	2 positions
Plums	60 - 70	8 - 10	3	1 / 4
Apricots	60 - 70	8 - 10	3	1 / 4
Apple slices	60 - 70	6 - 8	3	1 / 4
Pears	60 - 70	6 - 9	3	1 / 4

11.18 Bread Baking

Preheating is not recommended.

Food	Temperature (°C)	Time (min)	Shelf position
White Bread	180 - 200	40 - 60	2
Baguette	200 - 220	35 - 45	2
Brioche	180 - 200	40 - 60	2
Ciabatta	200 - 220	35 - 45	2
Rye Bread	190 - 210	50 - 70	2
Dark Bread	180 - 200	50 - 70	2
All Grain bread	170 - 190	60 - 90	2

11.19 Food Sensor table

Beef	Food core temperature (°C)		
	Rare	Medium	Well done
Roast beef	45	60	70
Sirloin	45	60	70

Beef	Food core temperature (°C)		
	Less	Medium	More
Meat loaf	80	83	86

Pork	Food core temperature (°C)		
	Less	Medium	More
Ham, Roast	80	84	88

Pork	Food core temperature (°C)		
	Less	Medium	More
Chop (saddle), Smoked pork loin, Smoked loin poached	75	78	82

Veal	Food core temperature (°C)		
	Less	Medium	More
Roast veal	75	80	85
Knuckle of veal	85	88	90

Mutton / lamb	Food core temperature (°C)		
	Less	Medium	More
Leg of mutton	80	85	88
Saddle of mutton	75	80	85
Leg of lamb, Roast lamb	65	70	75

Game	Food core temperature (°C)		
	Less	Medium	More
Saddle of hare, Saddle of venison	65	70	75
Leg of hare, Whole hare, Leg of venison	70	75	80

Poultry	Food core temperature (°C)		
	Less	Medium	More
Chicken (whole / half / breast)	80	83	86
Duck (whole / half), Turkey (whole / breast)	75	80	85
Duck (breast)	60	65	70

Fish (salmon, trout, zander)	Food core temperature (°C)		
	Less	Medium	More
Fish (whole / large / steamed), Fish (whole / large / roasted)	60	64	68

Casseroles - Precooked vegetables	Food core temperature (°C)		
	Less	Medium	More
Zucchini Casserole, Broccoli Casserole, Fennel Casserole	85	88	91

Casseroles - Savoury	Food core temperature (°C)		
	Less	Medium	More
Cannelloni, Lasagne, Pasta bake	85	88	91

Casseroles - Sweet	Food core temperature (°C)		
	Less	Medium	More
White bread casserole with / without fruits, Rice porridge casserole with / without fruits, Sweet noodle casserole	80	85	90

12. CARE AND CLEANING



WARNING!
Refer to Safety chapters.

12.1 Notes on cleaning

- Clean the front of the oven with a soft cloth with warm water and a cleaning agent.
- To clean metal surfaces, use a dedicated cleaning agent.
- Clean the oven interior after each use. Fat accumulation or other food remains may result in a fire. The risk is higher for the grill pan.
- Clean stubborn dirt with a special oven cleaner.
- Clean all accessories after each use and let them dry. Use a soft cloth with warm water and a cleaning agent.
- If you have nonstick accessories, do not clean them using aggressive agents, sharp-edged objects or a dishwasher. It can cause damage to the nonstick coating.

- Dry the oven when the cavity is wet after usage.

12.2 Removing the shelf supports

To clean the oven, remove the shelf supports.



CAUTION!
Be careful when you remove the shelf supports.

1. Pull the front of the shelf support away from the side wall.

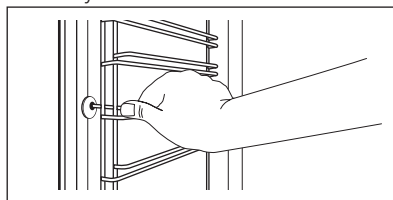

2. Pull the rear end of the shelf support away from the side wall and remove it.

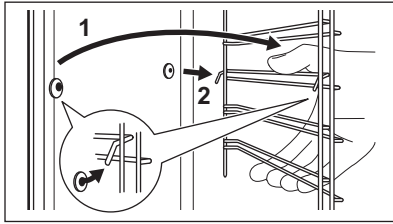

Install the removed accessories in the opposite sequence.

- i** The retaining pins on the telescopic runners must point to the front.

12.3 Pyrolysis

- !** **CAUTION!** Remove all accessories and removable shelf supports.

- i** **The pyrolytic cleaning procedure cannot start:**

- if you did not remove the core temperature sensor plug from the socket.
- if you did not fully close the oven door.

Remove the worst dirt manually.

- !** **CAUTION!** If there are other appliances installed in the same cabinet, do not use them at the same time as the function: Pyrolysis. It can cause damage to the appliance.

1. Clean the inner side of the door with hot water, so that the residues do not burn from the hot air.
2. Turn on the appliance and select from the main menu the function: Pyrolysis. Press **OK** to confirm.
3. Set the duration of the cleaning procedure:

Option	Description
Quick	1 h for a low degree of dirt

Normal	1 h 30 min for a usual degree of dirt
Intense	3 h for a high degree of dirt

4. Press **OK** to confirm.

- i** When the pyrolytic cleaning starts, the appliance door is locked and the lamp does not work.

- i** To stop the pyrolytic cleaning before it is completed, turn off the appliance.

- !** **WARNING!** After the function is completed, the appliance is very hot. Let it cool down. There is a risk of burns.

- i** After the function is completed, the door stays locked for the cool down phase. Some of the appliance functions are not available during the cool down phase.

12.4 Removing and installing the door

You can remove the door and the internal glass panels to clean it. The number of glass panels is different for different models.

- !** **WARNING!** Be careful when you remove the door from the appliance. The door is heavy.

1. Open the door fully.
2. Fully lift up the clamping levers (A) on the two door hinges.

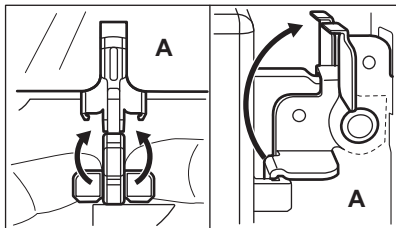

3. Close the door until it is at an angle of approximately 45°.

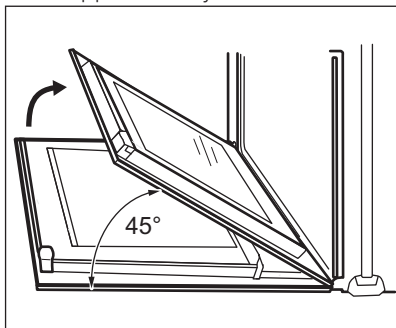

4. Hold the door with one hand on each side and pull it away from the appliance at an upwards angle.
 5. Put the door with the outer side down on a soft cloth on a stable surface. This is to prevent scratches.
 6. Hold the door trim (B) on the top edge of the door at the two sides and push inwards to release the clip seal.

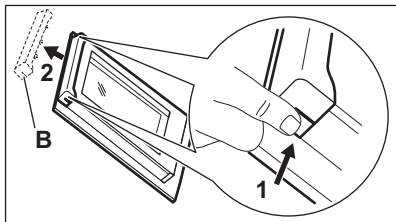

CAUTION!

Rough handling of the glass, especially around the edges of the front panel, can cause the glass to break.

7. Pull the door trim to the front to remove it.
 8. Hold the door glass panels on their top edge one by one and pull them out of the guide.

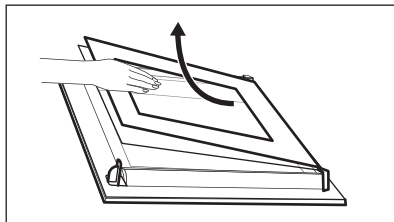

9. Clean the glass panel with water and soap. Dry the glass panel carefully. When the cleaning is completed, do the above steps in the opposite sequence. Install the smaller panel first, then the larger and the door.



WARNING!

Make sure that the glasses are inserted in the correct position otherwise the surface of the door may overheat.

Make sure that you put the glass panels (C, B and A) back in the correct sequence. First, insert panel C, which has a square printed on the left side and a triangle on the right side. You will also find those symbols embossed on the door frame. The triangle symbol on the glass must match the triangle on the door frame, and the square symbol must match the square. After that insert the other two glass panels.

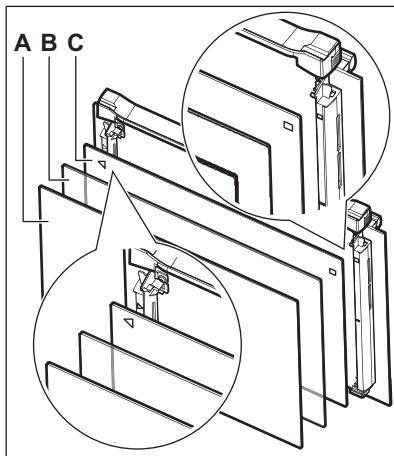

12.5 Replacing the lamp

Put a cloth on the bottom of the interior of the appliance. It prevents damage to the lamp glass cover and the cavity.



WARNING!

Danger of electrocution!
Disconnect the fuse before you replace the lamp.
The lamp and the lamp glass cover can be hot.

1. Deactivate the appliance.
2. Remove the fuses from the fuse box or deactivate the circuit breaker.

The top lamp

1. Turn the lamp glass cover counterclockwise to remove it.

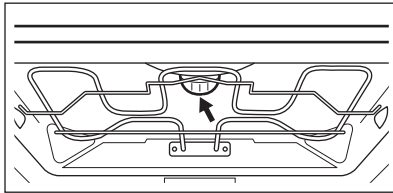

2. Clean the glass cover.
3. Replace the lamp with a suitable 300 °C heat-resistant lamp.

4. Install the glass cover.

The side lamp

1. Remove the left shelf support to get access to the lamp.
2. Use a narrow, blunt object (e.g. a teaspoon) to remove the glass cover.

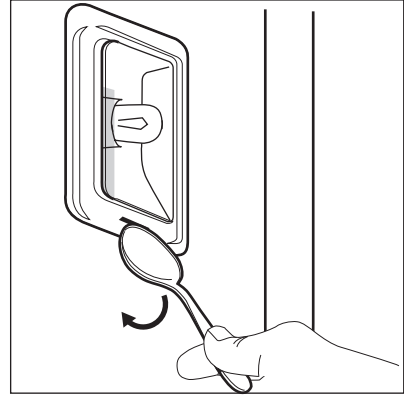

3. Clean the glass cover.
4. Replace the lamp with a suitable 300 °C heat-resistant lamp.
5. Install the glass cover.
6. Install the left shelf support.

13. TROUBLESHOOTING



WARNING!

Refer to Safety chapters.

13.1 What to do if...

Problem	Possible cause	Remedy
You cannot activate or operate the oven.	The oven is not connected to an electrical supply or it is connected incorrectly.	Check if the oven is correctly connected to the electrical supply (refer to the connection diagram if available).
The oven does not heat up.	The oven is deactivated.	Activate the oven.
The oven does not heat up.	The clock is not set.	Set the clock.
The oven does not heat up.	The necessary settings are not set.	Make sure that the settings are correct.
The oven does not heat up.	The automatic switch-off is activated.	Refer to "Automatic switch-off".

Problem	Possible cause	Remedy
The oven does not heat up.	The Child Lock is on.	Refer to "Using the Child Lock".
The oven does not heat up.	The door is not closed correctly.	Fully close the door.
The oven does not heat up.	The fuse is blown.	Make sure that the fuse is the cause of the malfunction. If the fuse is blown again and again, contact a qualified electrician.
The lamp does not operate.	The lamp is defective.	Replace the lamp.
The display shows F111.	The plug of the core temperature sensor is not correctly installed into the socket.	Put the plug of the core temperature sensor as far as possible into the socket.
The display shows an error code that is not in this table.	There is an electrical fault.	<ul style="list-style-type: none"> Deactivate the oven with the house fuse or the safety switch in the fuse box and activate it again. If the display shows the error code again, contact the Customer Care Department.
Steam and condensation settle on the food and in the cavity of the oven.	You left the dish in the oven for too long.	Do not leave the dishes in the oven for longer than 15 - 20 minutes after the cooking process ends.
The appliance is activated and does not heat up. The fan does not operate. The display shows " Demo ".	The demo mode is activated.	Refer to "Basic Settings" in "Daily use" chapter.

13.2 Service data

If you cannot find a solution to the problem yourself, contact your dealer or an Authorised Service Centre.

The necessary data for the service centre is on the rating plate. The rating plate is

on the front frame of the appliance cavity. Do not remove the rating plate from the appliance cavity.

We recommend that you write the data here:	
Model (MOD.)
Product number (PNC)

We recommend that you write the data here:

Serial number (S.N.)

14. ENERGY EFFICIENCY

14.1 Product Fiche and information according to EU 65-66/2014

Supplier's name	AEG	
Model identification	BPE742320M BPK742320B BPK742320M	
Energy Efficiency Index	81.2	
Energy efficiency class	A+	
Energy consumption with a standard load, conventional mode	0.99 kWh/cycle	
Energy consumption with a standard load, fan-forced mode	0.69 kWh/cycle	
Number of cavities	1	
Heat source	Electricity	
Volume	71 l	
Type of oven	Built-In Oven	
Mass	BPE742320M	38.0 kg
	BPK742320B	36.0 kg
	BPK742320M	38.0 kg

EN 60350-1 - Household electric cooking appliances - Part 1: Ranges, ovens, steam ovens and grills - Methods for measuring performance.

14.2 Energy saving



The oven contains features which help you save energy during everyday cooking.

General hints

Make sure that the oven door is closed properly when the appliance operates. Do not open the door too often during cooking. Keep the door gasket clean and make sure it is well fixed in its position.

Use metal dishes to improve energy saving.

When possible, do not preheat the oven before you put the food inside.

When the cooking duration is longer than 30 minutes, reduce the oven temperature to minimum 3 - 10 minutes before the end of the cooking time, depending on the duration of the cooking. The residual heat inside the oven will continue to cook.

Use the residual heat to warm up other dishes.

Keep breaks between baking as short as possible when you prepare few dishes at one time.

Cooking with fan

When possible, use the cooking functions with fan to save energy.

Residual heat

If a programme with the Duration or End Time selection is activated and the cooking time is longer than 30 minutes, the heating elements automatically deactivate earlier in some oven functions.

The fan and lamp continue to operate.

Keep food warm

Choose the lowest possible temperature setting to use residual heat and keep a meal warm. The residual heat indicator or temperature appears on the display.

Cooking with the lamp off

Turn off the lamp during cooking. Turn it on only when you need it.

Moist Fan Baking

Function designed to save energy during cooking. It operates in such a way that the temperature in the oven cavity may differ from the temperature indicated on the display during a cooking cycle and cooking times may be different from the cooking times in other programmes.

When you use Moist Fan Baking, the lamp automatically turns off after 30 seconds. You may turn on the lamp again but this action will reduce the expected energy savings.

15. ENVIRONMENTAL CONCERNS

Recycle materials with the symbol . Put the packaging in relevant containers to recycle it. Help protect the environment and human health by recycling waste of electrical and electronic appliances. Do not dispose of

appliances marked with the symbol  with the household waste. Return the product to your local recycling facility or contact your municipal office.

www.aeg.com/shop



867336222-E-282017



AEG