



OWNER'S MANUAL

# FRIDGE & FREEZER

**Read this owner's manual thoroughly before operating the appliance and keep it handy for reference at all times.**

EN ENGLISH



MFL71400013  
Rev.00\_030419

[www.lg.com](http://www.lg.com)

Refer to the owner's manual on LG website for more detailed information.

Copyright © 2019 LG Electronics Inc. All Rights Reserved

# TABLE OF CONTENTS

This manual may contain images or content different from the model you purchased.  
This manual is subject to revision by the manufacturer.

<b>SAFETY INSTRUCTIONS .....</b>	<b>3</b>
IMPORTANT SAFETY INSTRUCTIONS .....	3
<b>INSTALLATION.....</b>	<b>10</b>
Dimensions and Clearances .....	10
Ambient Temperature.....	11
Reversing Doors* .....	11
Leveling the Appliance .....	11
Installing the Stoppers.....	11
Connecting the Appliance .....	11
Moving the Appliance .....	11
<b>OPERATION .....</b>	<b>12</b>
Parts and Functions .....	12
Notes for Operation .....	14
Control Panel .....	16
Water Dispenser* .....	18
Water Dispenser tank .....	18
Ice Tray .....	19
Fresh Converter* .....	19
Fresh Vegetable Drawer* .....	20
Folding Shelf .....	20
Other Functions.....	21
<b>SMART FUNCTIONS.....</b>	<b>22</b>
Using LG SmartThinQ Application .....	22
Using Smart Diagnosis™ .....	24
<b>MAINTENANCE .....</b>	<b>26</b>
Notes for Cleaning .....	26
Cleaning the Door Basket .....	26
Cleaning the Shelf.....	27
Cleaning the Vegetable Drawer .....	27
Cleaning the Crisper Cover.....	27
Cleaning the Freezer Drawer .....	28
Cleaning the Water Dispenser .....	28
<b>TROUBLESHOOTING.....</b>	<b>29</b>

## SAFETY INSTRUCTIONS

EN

The following safety guidelines are intended to prevent unforeseen risks or damage from unsafe or incorrect operation of the appliance.

The guidelines are separated into 'WARNING' and 'CAUTION' as described below.

 This symbol is displayed to indicate matters and operations that can cause risk. Read the part with this symbol carefully and follow the instructions in order to avoid risk.

 **WARNING**

This indicates that the failure to follow the instructions can cause serious injury or death.

 **CAUTION**

This indicates that the failure to follow the instructions can cause the minor injury or damage to the product.

## IMPORTANT SAFETY INSTRUCTIONS

 **WARNING**

**To reduce the risk of explosion, fire, death, electric shock, injury or scalding to persons when using this product, follow basic precautions, including the following:**

### Children in the Household

- This appliance is not intended for use by persons (including children) with reduced physical, sensory or mental capabilities, or lack of experience and knowledge, unless they have been given supervision or instruction concerning use of the appliance by a person responsible for their safety. Children should be supervised to ensure that they do not play with the appliance.
- If the appliance is equipped with a lock (some models only), keep the key out of reach of children.

### **For use in Europe:**

- This appliance can be used by children aged from 8 years and above and persons with reduced physical, sensory or mental capabilities or lack of experience and knowledge if they have been given supervision or instruction concerning use of the appliance in a safe way and understand the hazards involved. Children shall not play with the appliance. Cleaning and user maintenance shall not be made by children without supervision.

### **Installation**

- This appliance should only be transported by two or more people holding the appliance securely.
- Ensure that the socket outlet is properly grounded, and that the earth pin on the power cord is not damaged or removed from the power plug. For more details on grounding, inquire at an LG Electronics customer information centre.
- This appliance is equipped with a power cord having an equipment-grounding conductor and a grounding power plug. The power plug must be plugged into an appropriate socket outlet that is installed and grounded in accordance with all local codes and ordinances.
- If the power cord is damaged or the hole of the socket outlet is loose, do not use the power cord and contact an authorized service centre.
- Do not plug the appliance into a multi socket adapter which does not have a power cable (mounted).
- Do not modify or extend the power cable.
- The appliance should be connected to a dedicated power line which is separately fused.
- Do not use a multi socket outlet which is not properly grounded (portable). In case of using a properly-grounded multi socket outlet (portable), use the multi socket outlet with the current capacity of the power code rating or higher and use the multi socket outlet only for the appliance.
- Install the appliance in a place where is easy to unplug the power plug of the appliance.
- Be careful not to point the power plug up or let the appliance lean against the power plug.

- Install the appliance on a firm and level floor.
- Do not install the appliance in a damp and dusty place. Do not install or store the appliance in any outdoor area, or any area that is subject to weathering conditions such as direct sunlight, wind, rain, or temperatures below freezing.
- Do not place the appliance in direct sunlight or expose it to the heat from heating appliances such as stoves or heaters.
- Be careful not to expose the rear of the appliance when installing.
- Be careful not to let the appliance door fall during assembly or disassembly.
- Be careful not to pinch, crush, or damage the power cable during assembly or disassembly of the appliance door.
- Do not connect a plug adapter or other accessories to the power plug.

## Operation

- Do not use the appliance for any purpose (storage of medical or experimental materials or shipping) other than any domestic household food storage use.
- Unplug the power plug during a severe thunderstorm or lightening or when not in use for a long period of time.
- Do not touch the power plug or the appliance controls with wet hands.
- Do not bend the power cable excessively or place a heavy object on it.
- If water penetrates electrical parts of the appliance, disconnect power plug and contact an LG Electronics customer information centre.
- Do not place hands or metallic objects inside the area emitting the cold air, cover or heat releasing grille on the back.
- Do not apply excessive force or impact to the back cover of the appliance.
- Do not put animals, such as pets into the appliance.
- Be careful of nearby children when you open or close the appliance door. The door may bump the child and cause injury.
- Avoid the danger of children getting trapped inside the appliance. A child trapped inside the appliance can cause suffocation.
- Do not place heavy or fragile objects, containers filled with liquid, combustible substances, flammable objects (such as candles, lamps, etc.), or heating devices (such as stoves, heaters, etc.) on the appliance.

- If there is a gas leakage (isobutane, propane, natural gas, etc.), do not touch the appliance or power plug and ventilate the area immediately. This appliance uses a refrigerant gas (isobutane, R600a). Although it uses a small amount of the gas, it is still combustible gas. Gas leakage during appliance transport, installation or operation can cause fire, explosion or injury if sparks are caused.
- Do not use or store flammable or combustible substances (ether, benzene, alcohol, chemical, LPG, combustible spray, insecticide, air freshener, cosmetics, etc.) near the appliance.
- Immediately unplug the power plug and contact an LG Electronics customer information centre if you detect a strange sound, odour, or smoke coming from the appliance.
- Fill with potable water only into icemaker or dispenser water tank.
- Do not damage the refrigerant circuit.
- Do not place any electronic appliance (such as heater and mobile phone) inside the appliance.

## Maintenance

- Disconnect the power cord before cleaning the appliance or replacing the inside lamp (where fitted).
- Securely plug the power plug in the socket outlet after completely removing any moisture and dust.
- Never unplug the appliance by pulling on the power cable. Always grip the power plug firmly and pull straight out from the socket outlet.
- Do not spray water or inflammable substances (toothpaste, alcohol, thinner, benzene, flammable liquid, abrasive, etc.) over the interior or exterior of the appliance to clean it.
- Do not clean the appliance with brushes, cloths or sponges with rough surfaces or which are made of metallic material.
- Only qualified service personnel from LG Electronics service centre should disassemble, repair, or modify the appliance. Contact an LG Electronics customer information centre if you move and install the appliance in a different location.

- Do not use a hair drier to dry the inside of the appliance or place a candle inside to remove the odours.
- Do not use mechanical devices or other means to accelerate the defrosting process.

## **Disposal**

- When discarding the appliance, remove the door gasket while leaving the shelves and baskets in place and keep children away from the appliance.
- Dispose of all packaging materials (such as plastic bags and styrofoam) away from children. The packaging materials can cause suffocation.

## **Technical Safety**

- Keep ventilation openings, in the appliance enclosure or in the built-in structure, clear of obstruction.
- Do not use electrical appliances inside the refrigerator.
- The refrigerant and insulation blowing gas used in the appliance require special disposal procedures. Consult with service agent or a similarly qualified person before disposing of them.
- Refrigerant leaking out of the pipes could ignite or cause an explosion.
- The amount of refrigerant in your particular appliance is shown on the identification plate inside the appliance.
- Never start up an appliance showing any signs of damage. If in doubt, consult your dealer.
- This appliance is intended to be used in household and similar applications only. It should not be used for commercial, or catering purposes, or in any mobile application such as a caravan or boat.
- Do not store explosive substances such as aerosol cans with a flammable propellant in this appliance.

## Risk of Fire and Flammable Materials



This symbol alerts you to flammable materials that can ignite and cause a fire if you do not take care.

- This appliance contains a small amount of isobutane refrigerant (R600a), but it is also combustible. When transporting and installing the appliance, care should be taken to ensure that no parts of the refrigerating circuit are damaged.
- If a leak is detected, avoid any naked flames or potential sources of ignition and air the room in which the appliance is standing for several minutes. In order to avoid the creation of a flammable gas air mixture if a leak in the refrigerating circuit occurs, the size of the room in which the appliance is used should correspond to the amount of refrigerant used. The room must be 1 m<sup>2</sup> in size for every 8 g of R600a refrigerant inside the appliance.
- When positioning the appliance, ensure the supply cord is not trapped or damaged.
- Do not locate multiple portable socket-outlets or portable power supplies at the rear of the appliance.

### CAUTION

**To reduce the risk of minor injury to persons, malfunction, or damage to the product or property when using this product, follow basic precautions, including the following:**

## Installation

- Do not tilt the appliance to pull or push it when transporting.
- Make sure not to get a body part such as a hand or foot stuck while moving the appliance.



## Operation

- Do not touch frozen food or the metal parts in the freezer compartment with wet or damp hands. It may cause frostbite.
- Do not place glass containers, bottles or cans (especially those containing carbonated drinks) in the freezer compartment, shelves or ice bin that will be exposed to temperatures below freezing.
- The tempered glass on the front side of the appliance door or the shelves can be damaged by an impact. If it is broken, do not touch it with hands.
- Do not hang from the appliance doors, storage room, shelf or climb up into it.
- Do not store an excessive amount of water bottles or containers for side dishes on the door baskets.
- Prevent animals from nibbling on the power cable or water hose.
- Do not open or close the appliance door with excessive force.
- If the hinge of the appliance door is damaged or operates improperly, stop using the appliance and contact an authorized service centre.
- Do not clean glass shelves or covers with warm water when they are cold. They may break if exposed to sudden temperature changes.
- Never eat frozen foods immediately after they have been taken out in the freezer compartment.
- Do not use a thin crystal cup or chinaware when dispensing.
- Make sure not to get a hand or foot stuck upon opening or closing the appliance door or door in door.

## Maintenance

- Do not insert the shelves upside down. The shelves may fall.
- To remove frost from the appliance, contact an LG Electronics customer information centre.
- Dispose of the ice inside the ice bin in the freezer compartment during an extended power outage.

## Dimensions and Clearances

- Too small of a distance from adjacent items may result in the degradation of freezing capability and increased electricity costs. Allow over 50 mm of clearance from each adjacent wall when installing the appliance.

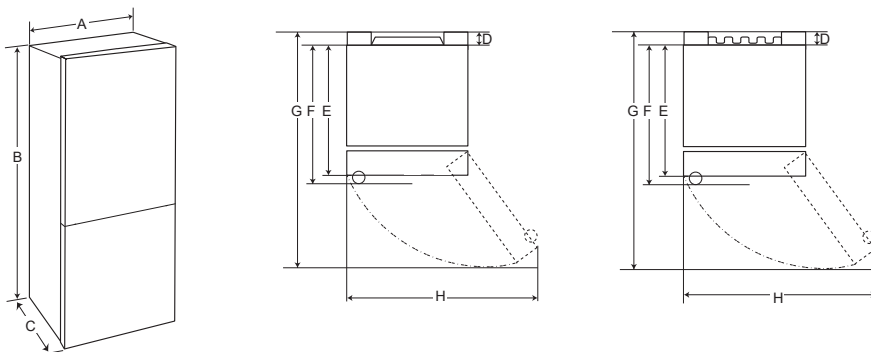

	Type A				Type B			
	Pocket Handle		Bar Handle		Pocket Handle		Bar Handle	
	Size [mm]							
A	595	595	595	595	595	595	595	595
B	1860	2030	1860	2030	1860	2030	1860	2030
C	676	676	731	731	682	682	737	737
D	9	9	9	9	15	15	15	15
E	667	667	667	667	667	667	667	667
F	-	-	722	722	-	-	722	722
G	1124	1124	1124	1124	1130	1130	1130	1130
H	995	995	995	995	995	995	995	995

## Ambient Temperature

- The appliance is designed to operate within a limited range of ambient temperatures, depending on the climate zone.
- The internal temperature could be affected by the location of the appliance, the ambient temperature, the frequency of door opening and so on.
- The climate class can be found on the rating label.

Climate Class	Ambient Temperature Range °C
SN (Extended Temperate)	+10 - +32
N (Temperate)	+16 - +32
ST (Subtropical)	+16 - +38
T (Tropical)	+16 - +43 / +10 - +43*

\*Australia, India, Kenya

### NOTE

- The appliances rated from SN to T are intended to be used at an ambient temperature between 10 °C and 43 °C.

## Reversing Doors\*

\* This feature varies depending on the model purchased.

Your appliance is designed with reversible doors, do that they may open from either the left of right hand side to suit your kitchen design.

### NOTE

- Reversing the doors must be performed by the qualified personnel of LG Electronics. If not, the doors will not be covered by the warranty.



## Leveling the Appliance

To avoid vibration, the unit must be leveled.

If required, adjust the leveling screws to compensate for the uneven floor.

The front should be slightly higher than the rear to aid in door closing.

Leveling screws can be turned easily by tipping the cabinet slightly.

Turn the leveling screws counterclockwise  to raise the unit, clockwise  to lower it.

## Connecting the Appliance

After installing the appliance, connect the power plug into a socket outlet.

### NOTE

- After connecting the power supply cord (or plug) to the outlet, wait 2 or 3 hours before you put food into the appliance. If you add food before the appliance has cooled completely, your food may spoil.

## Moving the Appliance

- 1 Remove all food from inside the appliance.
- 2 Pull the power plug out, insert and fix it into the power plug hook at the rear or on top of the appliance.
- 3 Tape parts such as shelves and the door handle to prevent from falling off while moving the appliance.
- 4 Move the appliance with more than two people carefully. When transporting the appliance over a long distance, keep the appliance upright.
- 5 After installing the appliance, connect the power plug into a socket out to switch on the appliance.

## Parts and Functions

\* This feature varies depending on the model purchased.

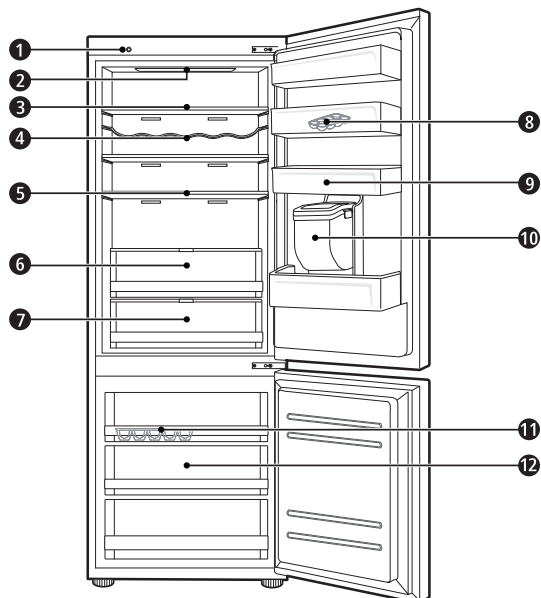

### 1 Smart Diagnosis Unit\*

This function is used when contacting LG Electronics customer information centre to help make an accurate diagnosis when the appliance operates abnormally or a failure occurs.

### 2 LED Lamp

This is where water to supply the dispenser. It requires manual filling. (Non plumbed models only)

### 3 Fridge Shelf

This is where refrigerated foods and other items are stored.

- The shelf height can be adjusted by inserting the shelf in another groove of different height.
- Store the foods with higher moisture content at the front of the shelf.
- The actual number of shelves will differ from model to model.

### 4 Bottle Rack\*

This is where drinks tall bottles or containers are stored.

**5 Folding Shelf\***

This is where refrigerated foods and high items are stored.

**6 Fresh Vegetable Drawer\***

This is where fruits and vegetables are stored to help maintain freshness by adjusting the humidity controller.

- The appearance or components of the appliance may differ from model to model.

**7 Fresh Converter\***

As a chill compartment, this is where meat, fish and vegetables are stored. Help maintain freshness by adjusting the humidity controller located in the back of the fridge compartment.

- For more space, you can use chill area without chill compartment drawer.

**8 Movable Egg Tray\***

This is where eggs are stored.

- You can move it to and use it at a desired position as needed. However, do not use it as the ice bin or place it on the shelf on top of the fridge or the vegetables drawer.

**9 Fridge Door Basket**

This is where small packages of refrigerated foods, drinks and sauce containers are stored.

**10 Water Dispenser Tank\***

This is where water to supply the dispenser or the automatic icemaker is stored. It requires manual filling. (Non plumbed models only)

**11 Ice Tray**

This is where ice is produced and stored.

- For more space, you can remove the ice tray or ice cubes bucket.

**12 Freezer Drawer**

This is for long-term storage of frozen items.

**! CAUTION**

- Do not store short bottles or containers on the bottle rack. The items may fall and cause an injury or appliance damage.

## Notes for Operation

- Users should keep in mind that frost can form. If the door is not closed completely, if the humidity is high during the summer, or if the freezer door is opened frequently.
- Ensure there is sufficient space between food stored on the shelf or door basket to allow the door to close completely.
- Opening the door lets warm air enter the appliance, and may cause the internal temperature to rise.
- If you are leaving the appliance turned off for an extended period of time, remove all food and unplug the power cord. Clean the interior, and leave the doors slightly ajar to prevent mold from growing in the appliance.

## Suggestion for Energy Saving

- Ensure there is sufficient space between stored foods. This allows cold air to be circulated evenly and lowers electricity bills.
- Store hot food only after it has cooled in order to prevent dew or frost.
- When storing food in the freezer compartment, set the freezer temperature lower than the temperature indicated on the food.
- Do not put food near the temperature sensor of the fridge compartment. Keep a distance of at least 3 cm from the sensor.
- Note that a temperature rise after defrosting has a permissible range in the appliance specifications. If you wish to minimise the impact this may have on the food storage due to a temperature rise, seal or wrap the stored food in several layers.
- The automatic defrosting system in the appliance ensures that the compartment remains free of ice build up under normal operating conditions.

## Storing Foods Effectively

- Store frozen food or refrigerated food inside sealed containers.
- Check the expiration date and label (storage instructions) before storing food in the appliance.
- Do not store food for a long period of time (more than four weeks) if it spoils easily at a low temperature.
- Place the refrigerated food or frozen food in each fridge or freezer compartment immediately after purchasing.
- Avoid refreezing any food which has been completely thawed. Freezing any food which has been completely thawed again will lower its taste and nutrition.
- Do not wrap and store vegetables with newspaper. Printing material of newspaper or other foreign substances may smear and contaminate food.
- Do not overfill the appliance. Cold air can not circulate properly if the appliance is overfilled.
- If you set an excessively low temperature for food, it may become frozen. Do not set a temperature lower than the required temperature for the food to be stored correctly.
- For more space, you can remove bottle rack, egg tray, ice tray and fresh converter drawer.

## Max Freezing Capacity

- The Express Freeze function will set the freezer to its maximum freezing capacity. This generally takes up to 24 hours and automatically switches off.
- If the maximum freezing capacity is to be used, Express Freeze must be switched on for seven hours before fresh produce is placed in the freezer compartment.

## Maximum Storage

- To get better air circulation, insert all drawers.
- If large quantities of food are to be stored, all the freezer drawers shall be taken out of the appliance except the bottom one and the food shall be stacked directly on the freezer shelves in the freezer compartment.

### NOTE

- To remove the drawers, first pick the food out of drawers. Then use the handle of drawers, pull out the drawers carefully. It may cause injury.
- The shape of each drawer may be different, insert in the right position.

## Control Panel

### Units and Functions

<Type 1> On the Fridge Door

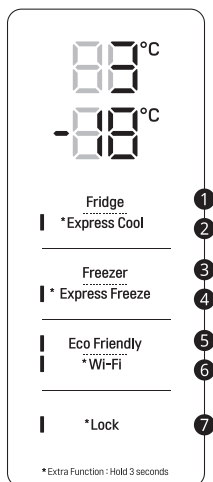

<Type 2> Inside the Fridge

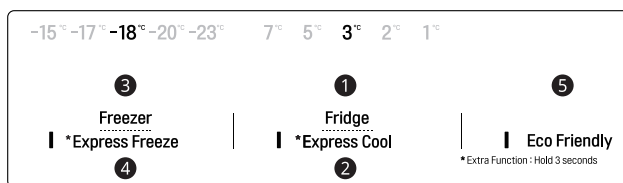

- 1 Fridge Temperature**
  - This sets the fridge target temperature.
- 2 Express Cool**
  - This sets Express Cool functions.
- 3 Freezer Temperature**
  - This sets the freezer target temperature.
- 4 Express Freeze**
  - This sets Express Freeze functions.
- 5 Eco Friendly**
  - This controls the Power Save mode for lowering energy consumption.
- 6 Wi-Fi**
  - This sets the appliance to connect to your home's Wi-Fi network.
- 7 Lock**
  - This locks the buttons on the control panel.

### NOTE

- The actual control panel may differ from model to model.
- The control panel will turn off automatically for energy saving.
- If there is any finger or skin contacts to the control panel while cleaning it, the button function may operate.



## Setting the Temperature

This sets the fridge temperature or freezer temperature.

- Press the **Fridge** button or **Freezer** button to adjust the temperature.
- The temperature can be adjusted.
  - Fridge : from 1 °C to 7 °C
  - Freezer : from -15 °C to -23 °C
- The initial temperature is set.
  - Fridge : 3 °C
  - Freezer : -18 °C
- The actual inner temperature varies depending on the food status, as the indicated setting temperature is a target temperature, not actual temperature within the appliance.

### NOTE

- The default temperature setting may vary depending on the appliance.
- Wait until 2 or 3 hours have passed after connecting the appliance to the outlet before storing food in the appliance.

## Setting Express Freeze

The function can quickly freeze a large amount of ice or frozen foods.

- When you press the **Express Freeze** button for 3 seconds, the **Express Freeze** icon lights on the control panel.
- The function is enabled and disabled in turn each time you press the button.
- The Express Freeze function automatically terminates after a specific period (around 24 hours) has passed.

### NOTE

- When **Express Freeze** is switched on, noise may occur and energy consumption may increase.

## Setting Express Cool

The function can quickly cool a large amount of foods.

- When you press the **Express Cool** button for 3 seconds, the **Express Cool** icon lights on the control panel.
- The function is enabled and disabled in turn each time you press the button.
- The Express Cool function automatically terminates after a specific period (around 7 hours) has passed.

### NOTE

- When **Express Cool** is switched on, noise may occur and energy consumption may increase.

## Setting Eco Friendly

- The function makes the fridge-freezer work in the power saving mode which is useful when you are away on a holiday as it reduces energy consumption.
- Pressing the **Eco Friendly** button starts the operation with the lamp on, and pressing it again stops the operation.
- When the Eco Friendly mode is on, the other buttons will not operate. When you finish using the Eco Friendly mode, turn it off so that other buttons work and the refrigerator returns to its previous temperature setting.

## Setting and Resetting Lock

This locks the buttons on the control panel.

- Press and hold the **Lock** button for three seconds. When the Lock function is set, all buttons are locked.

### NOTE

- You must deactivate Lock function before you can access any other functions.

## High Temperature Alarm

When the freezer temperature goes too high due to power failure, the freezer temperature LED lamp blinks and an alarm sounds.

- Press the **Freezer** button to stop.
- If the temperature is sufficiently cold, the blinking and alarm will automatically stop.
- This function operates:
  - When the refrigerator is turned on.
  - When the freezer compartment gets too warm.
  - When there is a power outage that lasts for a long period of time.
  - When large amounts of warm food are placed in the freezer compartment.
  - When the freezer door is left open for too long or too frequently.

## Water Dispenser\*

\* This feature varies depending on the model purchased.

Press the lever **1** of the water dispenser to get cold water.

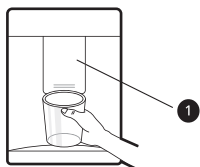

### **CAUTION**

- Keep children away from the dispenser to prevent children playing with or damaging the controls.

### NOTE

- If you open the freezer door while water is being dispensed, the water supply will stop.
- If you open the fridge door while water is being dispensed, dispensing will be paused.
- If the cup rim is small, water may splash out of the glass or miss it completely.
- Use a cup with a rim of over 68 mm in diameter when dispensing water.

## Water Dispenser tank

- 1 Open the cap (small cover) on the top of the water tank.



- 2 Fill the water tank with potable water and close the cap (small cover).
  - The water tank can hold up to 2.3 L.

### **CAUTION**

- Children should not be allowed near the dispenser tank. If the child drops the water dispenser tank while it is completely filled with water, injury may occur. Do not fill the water tank with drinks other than water or fill with hot water.
- Do not apply excessive force or impact when removing or assembling the water dispenser tank. Doing so can cause appliance damage or injury.

### NOTE

- Before using the water dispenser tank after installing the appliance, it should be washed before filling it with water.
- Check if the water dispenser tank has been placed on the appliance correctly. If it is not assembled correctly, water may leak from the tank into the appliance.
- If there is no water in the water dispenser tank, the water function of the dispenser cannot be used. Check if there is water in the water dispenser tank and then fill it with water if there is not.
- Sound from the water tank will be normal when supplying water to the dispenser. It is not a sign of malfunction.
- ( \* ): This feature varies depending on the model purchased.

## Ice Tray

Fill the ice tray with water.

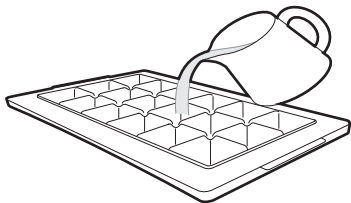

### ⚠ WARNING

- Fill with potable water only.

### ⚠ CAUTION

- Check whether there is any ice remaining in the tray before putting water into it.
- Do not slam the freezer door after filling the ice tray with water.
- If you open and close the freezer door frequently, it may take longer for the water to freeze.
- The time it takes for the water to freeze may vary according to the season.
- The temperature inside the appliance can take up to 24 hours to stabilize after initial installation. Water may take longer to freeze because of this.
- Be careful when handling the ice as the edges of the ice may be sharp.

### NOTE

- If the ice tray is overfilled, the ice may stick together and be difficult to remove.
- Press the Express Freeze button on the control panel to make ice quickly.
- Do not store ice that has not frozen completely. Unfrozen water could cause the ice to clump together.
- Be careful not to use excessive force when twisting the ice tray. Doing so could break the ice tray.
- To easily remove ice, fill water up the tray in advance.

## Fresh Converter\*

\* This feature varies depending on the model purchased.

As a chill compartment, the temperature in the fresh converter can be controlled by sliding the lever **1**, where located in front of compartment, in either direction.

When keeping vegetables after setting up Meat or Fish, the cold injury may occur.

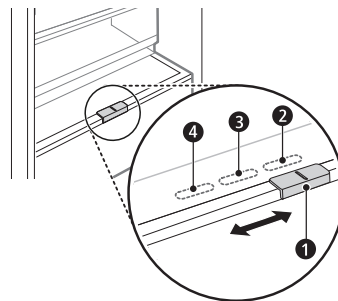

- **2** For storing vegetables. (Recommended)
- **3** For storing fish.
- **4** For storing meat.

## Fresh Vegetable Drawer\*

\* This feature varies depending on the model purchased.

Vegetable compartment can adjust the humidity by moving the knob ❶.

- 1 Lift the front side of the shelf and shift it on its back side.

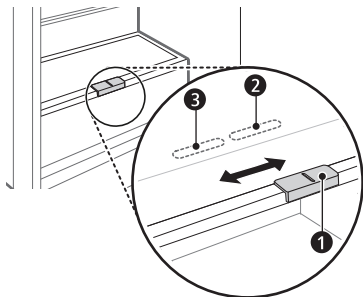

- 2 For storing vegetables. (Recommended)
- 3 For storing fish.

## Folding Shelf

Store taller items, such as a gallon container or bottles, by pushing the front half of the shelf underneath the back half the shelf. Pull the front of the shelf forward to return to a full shelf.

- 1 Lift the front side of the shelf and shift it on its back side.

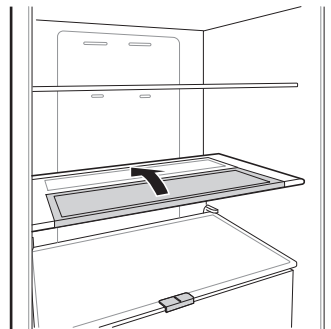

- 2 Lift the front side of the shelf and shift it under its back side. From this position, both sides of the shelf can be lifted up to free more space.

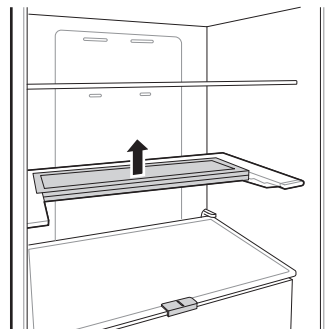

## Other Functions

### Door Open Alarm

The alarm sounds 3 times in 30 second intervals if the fridge door is left open or not completely closed for one minute.

- Contact the LG Electronics customer information centre if the alarm sound continues even after closing the door.

### Failure Detection

The appliance can automatically detect problems during the operation.

- If a problem is detected, the appliance may not operate and an error code is displayed even when any button is pressed.
- When this occurs, do not turn off the power and immediately contact the LG Electronics customer information centre. If you turn off the power, the repair technician from the LG Electronics customer information centre may have difficulty finding the problem.

## Using LG SmartThinQ Application

- For appliances with the  or  logo

The LG SmartThinQ application allows you to communicate with the appliance using a smartphone.

### Before Using LG SmartThinQ

- 1 Check the distance between the appliance and the wireless router (Wi-Fi network).
  - If the distance between the appliance and the wireless router is too far, the signal strength becomes weak. It may take a long time to register or installation may fail.
- 2 Turn off the **Mobile data** or **Cellular Data** on your smartphone.

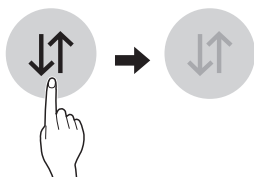

- 3 Connect your smartphone to the wireless router.

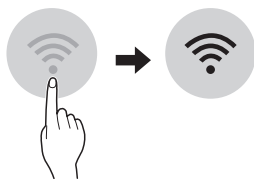

### NOTE

- To verify the Wi-Fi connection, check that **Wi-Fi**  icon on the control panel is lit.
- The appliance supports 2.4 GHz Wi-Fi networks only. To check your network frequency, contact your Internet service provider or refer to your wireless router manual.

- LG SmartThinQ is not responsible for any network connection problems or any faults, malfunctions, or errors caused by network connection.
- If the appliance is having trouble connecting to the Wi-Fi network, it may be too far from the router. Purchase a Wi-Fi repeater (range extender) to improve the Wi-Fi signal strength.
- The Wi-Fi connection may not connect or may be interrupted because of the home network environment.
- The network connection may not work properly depending on the Internet service provider.
- The surrounding wireless environment can make the wireless network service run slowly.
- The appliance cannot be registered due to problems with the wireless signal transmission. Unplug the appliance and wait about a minute before trying again.
- If the firewall on your wireless router is enabled, disable the firewall or add an exception to it.
- The wireless network name (SSID) should be a combination of English letters and numbers. (Do not use special characters.)
- Smartphone user interface (UI) may vary depending on the mobile operating system (OS) and the manufacturer.
- If the security protocol of the router is set to **WEP**, you may fail to set up the network. Please change it to other security protocols (**WPA2** is recommended) and register the product again.

### Installing LG SmartThinQ

Search for the LG SmartThinQ application from the Google Play Store or Apple App Store on a smart phone. Follow instructions to download and install the application.

## LG SmartThinQ Application Features for Wi-Fi models

Communicate with the appliance from a smart phone using the convenient smart features.

### Firmware Update

Keep the appliance performance updated.

### Smart Diagnosis™

If you use the Smart Diagnosis function, you will be provided with the useful information such as a correct way of using the appliance based on the pattern of use.

### Settings

Allows you to set various options on the appliance and in the application.

### NOTE

- If you change your wireless router, Internet service provider, or password, delete the registered appliance from the LG SmartThinQ application and register it again.
- The application is subject to change for appliance improvement purposes without notice to users.
- Functions may vary by model.

## Connecting to Wi-Fi

The **Wi-Fi** button, when used with the LG SmartThinQ application, allows the appliance to connect to a home Wi-Fi network. The **Wi-Fi** icon shows the status of the appliance's network connection. The icon illuminates when the appliance is connected to the Wi-Fi network.

### Initial Appliance Registration

Run the LG SmartThinQ application and follow the instructions in the application to register the appliance.

### Re-registering the Appliance or Registering Another User

Press and hold the **Wi-Fi** button for 3 seconds to temporarily turn it off. Run the LG SmartThinQ application and follow the instructions in the application to register the appliance.

### NOTE

- To disable the Wi-Fi function, press and hold the **Wi-Fi** button for 3 seconds. Wi-Fi icon will be turned off.

## Wireless LAN Module Specifications

<b>Model</b>	LCW-004
<b>Frequency Range</b>	2412 to 2472 MHz
<b>Output Power(Max)</b>	IEEE 802.11b:17.82 dBm IEEE 802.11g:17.72 dBm IEEE 802.11n:16.61 dBm

Wireless function S/W version : V 1.0

For consideration of the user, this device should be installed and operated with a minimum distance of 20 cm between the device and the body.

## Declaration of Conformity



Hereby, LG Electronics declares that the radio equipment type Refrigerator is in compliance with Directive 2014/53/EU. The full text of the EU declaration of conformity is available at the following internet address:

<http://www.lg.com/global/support/cedoc/cedoc#>  
LG Electronics European Shared Service Centre B.V.

Krijgsman 1  
1186 DM Amstelveen  
The Netherlands

## Open Source Software Notice Information

To obtain the source code under GPL, LGPL, MPL, and other open source licenses, that is contained in this product, please visit <http://opensource.lge.com>.

In addition to the source code, all referred license terms, warranty disclaimers and copyright notices are available for download.

LG Electronics will also provide open source code to you on CD-ROM for a charge covering the cost of performing such distribution (such as the cost of media, shipping, and handling) upon email request to [opensource@lge.com](mailto:opensource@lge.com). This offer is valid for a period of three years after our last shipment of this product. This offer is valid to anyone in receipt of this information.

## Using Smart Diagnosis™

- For appliances with the  or  logo

### Smart Diagnosis™ Through the Customer Information Centre

Use this function if you need an accurate diagnosis by an LG Electronics customer information centre when the appliance malfunctions or fails. Use this function only to contact the service representative, not during normal operation.

### Display panel is on the Fridge door.

- 1 Press the **Lock** button to activate the lock function.
  - If the display has been locked for over 5 minutes, you must deactivate the lock and then reactivate it.
- 2 Press and hold the **Freezer** button for three seconds or longer while continuing to hold your phone to the speaker.
- 3 Open the fridge door and then hold the phone on the upper right speaker hole.

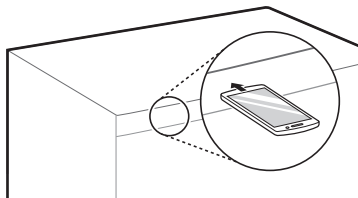

- 4 After the data transfer is complete, the service agent will explain the result of the Smart Diagnosis™.

### Display panel is inside the Fridge door

- 1 Open the fridge door.
- 2 Press the **Eco Fiendly** button.
  - If the door has been open for longer than 60 seconds, close the door and repeat steps 1 and 2.
- 3 Hold the phone on the upper right speaker hole.

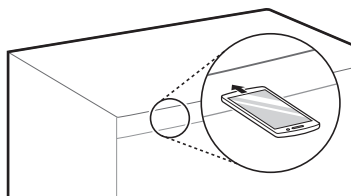

- 4 Press and hold the **Freezer** button for 3 seconds while holding your phone in front of the speaker.
- 5 After the data transfer is complete, the service agent will explain the result of the Smart Diagnosis™.



**NOTE**

- Position the phone so that its microphone is aligned with the speaker hole.
- The Smart Diagnosis™ sound is generated after around three seconds.
- Do not take the phone off the speaker hole while the data is transmitted.
- Hold the phone to the upper right speaker hole and wait while the data is transmitted.
- The data transfer sound may be harsh to the ear while the Smart Diagnosis™ data is being transmitted, but do not take the phone off the speaker hole for accurate diagnosis until the data transfer sound has stopped.
- When the data transfer is complete, the transfer completion message is displayed and the control panel is automatically turned off and then on again after a few seconds. Afterwards the customer information centre explains the diagnosis result.
- The Smart Diagnosis™ function depends on the local call quality.
- The communication performance will improve and you can transmit a better signal if you use a land line home phone.
- If the Smart Diagnosis™ data transfer is poor due to poor call quality, you may not receive the best Smart Diagnosis™ service.

## Notes for Cleaning

- When removing a shelf or drawer from inside the appliance, remove all stored foods from the shelf or drawer to prevent injury or damage to the appliance.
  - Otherwise, injury may occur due to the weight of stored foods.
- If cleaning the outside air vents of the appliance by means of vacuuming, then the power cord should be unplugged from the outlet to avoid any static discharge that can damage the electronics or cause an electric shock.
- Detach the shelves and drawers and clean them with water, and then dry them sufficiently, before replacing them.
- Regularly wipe the door gaskets with a wet soft towel.
- Door basket spills and stains should be cleaned as they can compromise storage ability of the basket and could even be damaged.
- After cleaning, check if the power cable is damaged, warm or improperly plugged.
- Keep the air vents on the exterior of the appliance clean.
  - Blocked air vents can cause fire or appliance damage.
- Waxing external painted metal surfaces helps provide rust protection. Do not wax plastic parts. Wax painted metal surfaces at least twice a year using appliance wax (or auto paste wax). Apply wax with a clean, soft cloth.
- When cleaning the inside or outside of the appliance, do not wipe it with a rough brush, toothpaste, or flammable materials. Do not use cleaning agents containing flammable substances.
  - This may cause discoloration or damage to the appliance.
  - Flammable substances: alcohol (ethanol, methanol, isopropyl alcohol, isobutyl alcohol, etc.), thinner, bleach, benzene, flammable liquid, abrasive, etc.
- For the appliance exterior, use a clean sponge or soft cloth and a mild detergent in warm water. Do not use abrasive or harsh cleaners. Dry thoroughly with a soft cloth.
- Never clean the shelves or containers in the dishwasher.
  - The parts may become deformed due to the heat.

- If the appliance is equipped with an LED lamp, do not remove lamp cover and LED lamp in any attempt to repair or service it. Please, contact the LG Electronics customer information centre.

## Cleaning the Door Basket

### Removing the Fridge Door Basket

Hold both edges of the basket and remove it by lifting it upward.

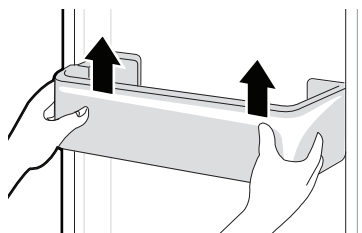

### Refitting the Fridge Door Basket

- 1 Hold both edges of the door basket, gently push one edge to assemble, and then in the same manner assemble the other edge.

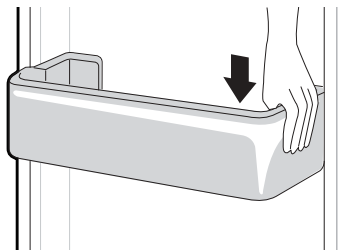

- 2 After assembling, tap the door basket gently to fix it horizontally.

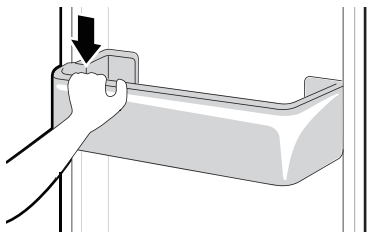

- 2 Lift the vegetable drawer up and remove it by pulling it out.

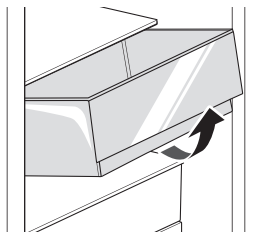

## Cleaning the Shelf

### Removing the Fridge Shelf

Lift the rear edge of the fridge shelf and then pull it out.

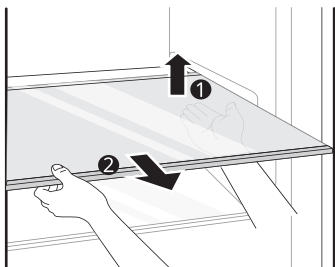

### Refitting the Fridge Shelf

Refit the shelf in the reverse order of the removal process.

## Cleaning the Vegetable Drawer

### Removing the Vegetable Drawer

- 1 Remove the contents of the drawer. Hold the handle of the vegetable drawer and pull it out completely until it stops.

## ⚠ CAUTION

- Note that injuries can be caused by the weight of stored foods when removing the vegetable drawer.

### Refitting the Vegetable Drawer

Refit the vegetable drawer in the reverse order of the removal process.

## Cleaning the Crisper Cover

### Removing the Crisper Cover

- 1 After removing the vegetable drawer cover, pull the top section of the crisper cover down.

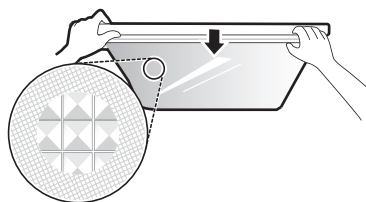

- 2 Remove the crisper cover by pulling it out.

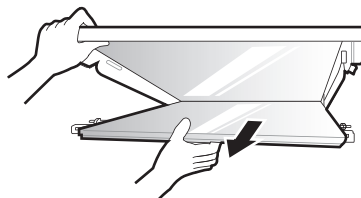

## Refitting the Crisper Cover

- 1 Place the protrusions inside the crisper cover on the grooves inside the shelf.

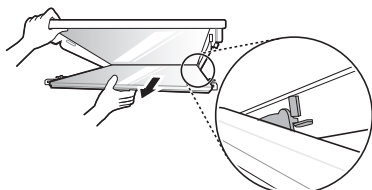

- 2 Insert the protrusions in front of the crisper cover into the grooves in front of the shelf and push the crisper cover up to assemble.

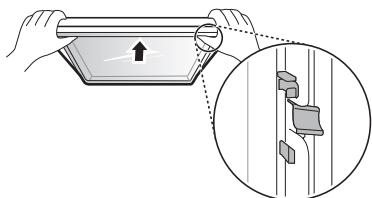

## Cleaning the Freezer Drawer

- 1 Remove the contents of the drawer. Hold the handle of the freezer drawer and pull it out completely until it stops.
- 2 Lift the freezer drawer up and remove it by pulling it out.

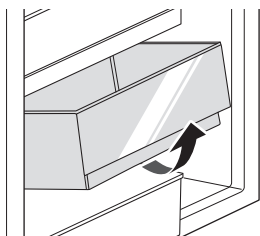

## Refitting the Freezer Drawer

Refit the freezer drawer in the reverse order of the removal process.

## Cleaning the Water Dispenser

### Cleaning the Dispenser Tray



The dispenser tray may become wet easily due to spilled ice or water. Wipe the entire area with a damp cloth.

### Cleaning the Water and Ice Outlet

Wipe the water or ice outlet frequently with a clean cloth as it may get dirty easily. Please note that lint from a cloth may adhere to the outlet.

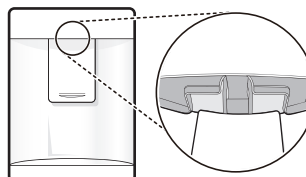

# TROUBLESHOOTING

EN

Symptoms	Reason	Solution
There is no refrigeration or freezing.	Is there a power interruption?	<ul style="list-style-type: none"> <li>• Check the power of other appliances.</li> </ul>
	If the power plug unplugged from the outlet?	<ul style="list-style-type: none"> <li>• Plug the power plug in the outlet properly.</li> </ul>
There is poor refrigeration or freezing.	Is the fridge or freezer temperature set to its warmest setting?	<ul style="list-style-type: none"> <li>• Set the fridge or freezer temperature to 'Medium'.</li> </ul>
	Is the appliance in direct sunlight, or is it near a heat generating object such as cooking oven or heater?	<ul style="list-style-type: none"> <li>• Check the installation area and reinstall it away from heat generating objects.</li> </ul>
	Did you store hot food without cooling it first?	<ul style="list-style-type: none"> <li>• Cool the hot food first before putting it in the fridge or freezer compartment.</li> </ul>
	Did you put in too much food?	<ul style="list-style-type: none"> <li>• Maintain an appropriate space between food.</li> </ul>
	Are the appliance doors completely closed?	<ul style="list-style-type: none"> <li>• Completely close the door and make sure that stored food is not obstructing in the door.</li> </ul>
	Is there enough space around the appliance?	<ul style="list-style-type: none"> <li>• Adjust the installation position to make enough space around the appliance.</li> </ul>
The appliance contains a bad smell.	Is the fridge or freezer temperature set to 'Warm'?	<ul style="list-style-type: none"> <li>• Set the fridge or freezer temperature to 'Medium'.</li> </ul>
	Did you put in food with a strong smell?	<ul style="list-style-type: none"> <li>• Store foods with strong smells in a sealed containers.</li> </ul>
	Vegetables or fruit may have spoiled in the drawer?	<ul style="list-style-type: none"> <li>• Throw away rotten vegetables and clean the vegetable drawer. Do not store vegetables too long in the vegetable drawer.</li> </ul>
The inside lamp in the appliance does not turn on.	Does the inside lamp in the appliance turn off?	<ul style="list-style-type: none"> <li>• It is not possible for customers to replace the inside lamp in the appliance as they are not serviceable. If the inside lamp does not turn on, please contact the LG Electronics customer information centre.</li> </ul>

Symptoms	Reason	Solution
The appliance door is not closed tightly.	Is the appliance leaning forward?	<ul style="list-style-type: none"> <li>Adjust the front feet to raise the front side slightly.</li> </ul>
	Were the shelves properly assembled?	<ul style="list-style-type: none"> <li>Refit the shelves if needed.</li> </ul>
	Did you close the door with excessive force?	<ul style="list-style-type: none"> <li>If you apply too much force or speed when closing the door, it may remain briefly open before closing. Make sure that you do not slam the door closed. Close without force.</li> </ul>
It is difficult to open the appliance door.	Did you open the door right after you closed it?	<ul style="list-style-type: none"> <li>If you try to open the appliance door within one minute after you closed it, you may have difficulties because of the pressure inside the appliance. Try to open the appliance door again in a few minutes so that the internal pressure stabilizes.</li> </ul>
There is condensation inside the appliance or on the bottom of the vegetable drawer cover.	Did you store hot food without cooling it first?	<ul style="list-style-type: none"> <li>Cool the hot food first before putting it in the fridge or freezer compartment.</li> </ul>
	Did you leave the appliance door open?	<ul style="list-style-type: none"> <li>Although the condensation will disappear soon after you close the appliance door, you can wipe it with a dry cloth.</li> </ul>
	Do you open and close the appliance door too frequently?	<ul style="list-style-type: none"> <li>Condensation can form due to the temperature difference from the outside. Wipe out the dampness with a dry cloth.</li> </ul>
	Did you put warm or moist food inside without sealing it in a container?	<ul style="list-style-type: none"> <li>Store food in a covered or sealed container.</li> </ul>
Frost has formed in the freezer compartment.	Doors may not be closed properly?	<ul style="list-style-type: none"> <li>Check if the food item inside the appliance is blocking the door and make sure that the door is tightly closed.</li> </ul>
	Did you store hot food without cooling it first?	<ul style="list-style-type: none"> <li>Cool the hot food first before putting it in the fridge or freezer compartment.</li> </ul>

Symptoms	Reason	Solution
Frost has formed in the freezer compartment.	Is the air entry or exit of the freezer compartment blocked?	<ul style="list-style-type: none"> <li>Make sure that air entry or exit is not blocked so that the air can circulate inside.</li> </ul>
	Is the freezer compartment overfilled?	<ul style="list-style-type: none"> <li>Maintain an appropriate space between items.</li> </ul>
Frost or condensation has formed inside or outside the appliance.	Did you open and close the appliance door frequently or is the appliance door improperly closed?	<ul style="list-style-type: none"> <li>Frost or condensation can form if the outside air penetrates inside the appliance.</li> </ul>
	Is the installation environment humid?	<ul style="list-style-type: none"> <li>Condensation can appear on the exterior of the appliance if the installation area is too humid or on a humid day such as a rainy day. Wipe off any moisture with a dry cloth.</li> </ul>
The appliance is noisy and generates abnormal sounds.	Is the appliance installed on a weak floor or improperly leveled?	<ul style="list-style-type: none"> <li>Install the appliance on a solid and flat area.</li> </ul>
	Does the rear of the appliance touch the wall?	<ul style="list-style-type: none"> <li>Adjust the installation position to allow enough clearance around the appliance.</li> </ul>
	Are objects scattered behind the appliance?	<ul style="list-style-type: none"> <li>Remove the scattered objects from behind the appliance.</li> </ul>
	Is there an object on top of the appliance?	<ul style="list-style-type: none"> <li>Remove the object on top of the appliance.</li> </ul>
The side or front of the appliance is warm.	There are anti condensation pipes fitted to these areas of the appliance to reduce condensation forming from around the door area.	<ul style="list-style-type: none"> <li>The heat releasing pipe to prevent condensation is installed on the front and side of the appliance. You may feel it particularly hot right after the appliance is installed or during the summer. You can be assured that this is not a problem and is quite normal.</li> </ul>
There is water inside or outside of the appliance.	Is there water leakage around the appliance?	<ul style="list-style-type: none"> <li>Check if the water has leaked from a sink or another place.</li> </ul>
	Is there water on the bottom of the appliance?	<ul style="list-style-type: none"> <li>Check if the water is from the thawed frozen food or a broken or dropped container.</li> </ul>
Water does not come out.	The water dispenser tank may be empty? (Non plumbed models only)	<ul style="list-style-type: none"> <li>Fill the water dispenser tank.</li> </ul>

Symptoms	Reason	Solution
Clicking noises	The defrost control will click when the automatic defrost cycle begins and ends. The thermostat control (or appliance control on some models) will also click when cycling on and off.	<ul style="list-style-type: none"> <li>• Normal Operation</li> </ul>
Rattling noises	Rattling noises may come from the flow of appliance, the water line on the back of the unit (for plumbed models only), or items stored on top of or around the appliance.	<ul style="list-style-type: none"> <li>• Normal Operation</li> </ul>
	Appliance is not resting evenly on the floor.	<ul style="list-style-type: none"> <li>• Floor is weak or uneven or leveling legs need to be adjusted. See the Door Alignment section.</li> </ul>
	Appliance with linear compressor was moved while operating.	<ul style="list-style-type: none"> <li>• Normal operation. If the compressor does not stop rattling after three minutes, turn the power to the appliance off and then on again.</li> </ul>
Whooshing noises	Evaporator fan motor is circulating air through the fridge and freezer compartments.	<ul style="list-style-type: none"> <li>• Normal Operation</li> </ul>
	Air is being forced over the condenser by the condenser fan.	<ul style="list-style-type: none"> <li>• Normal Operation</li> </ul>
Gurgling noises	Appliance flowing through the cooling system	<ul style="list-style-type: none"> <li>• Normal Operation</li> </ul>
Popping noises	Contraction and expansion of the inside walls due to changes in temperature.	<ul style="list-style-type: none"> <li>• Normal Operation</li> </ul>
Vibrating	If the side or back of the appliance is touching a cabinet or wall, some of the normal vibrations may make an audible sound.	<ul style="list-style-type: none"> <li>• To eliminate the noise, make sure that the sides and back do not make any contact with any wall or cabinet.</li> </ul>



Symptoms	Reason	Solution
Your home appliance and smartphone are not connected to the Wi-Fi network.	The password for the Wi-Fi that you are trying to connect to is incorrect.	<ul style="list-style-type: none"> <li>Find the Wi-Fi network connected to your smartphone and remove it, then register your appliance on LG SmartThinQ.</li> </ul>
	Mobile data for your smartphone is turned on.	<ul style="list-style-type: none"> <li>Turn off the <b>Mobile data</b> of your smartphone and register the appliance using the Wi-Fi network.</li> </ul>
	The wireless network name (SSID) is set incorrectly.	<ul style="list-style-type: none"> <li>The wireless network name (SSID) should be a combination of English letters and numbers. (Do not use special characters.)</li> </ul>
	The router frequency is not 2.4 GHz.	<ul style="list-style-type: none"> <li>Only a 2.4 GHz router frequency is supported. Set the wireless router to 2.4 GHz and connect the appliance to the wireless router. To check the router frequency, check with your Internet service provider or the router manufacturer.</li> </ul>
	The distance between the appliance and the router is too far.	<ul style="list-style-type: none"> <li>If the distance between the appliance and the router is too far, the signal may be weak and the connection may not be configured correctly. Move the location of the router so that it is closer to the appliance.</li> </ul>

## Disposal of Your Old Appliance



- This crossed-out wheeled bin symbol indicates that waste electrical and electronic products (WEEE) should be disposed of separately from the municipal waste stream.
- Old electrical products can contain hazardous substances so correct disposal of your old appliance will help prevent potential negative consequences for the environment and human health. Your old appliance may contain reusable parts that could be used to repair other products, and other valuable materials that can be recycled to conserve limited resources.
- You can take your appliance either to the shop where you purchased the product, or contact your local government waste office for details of your nearest authorised WEEE collection point. For the most up to date information for your country please see [www.lg.com/global/recycling](http://www.lg.com/global/recycling).

