

User manual  
Washing machine

HW60-12829

HW70-12829

GB

**Haier**

## Thank you for purchasing a Haier Product.

Please read these instructions carefully before using this appliance. The instructions contain important information which will help you get the best out of the appliance and ensure safe and proper installation, use and maintenance.

Keep this manual in a convenient place so you can always refer to it for the safe and proper use of the appliance.

If you sell the appliance, give it away, or leave it behind when you move house, make sure you also pass this manual so that the new owner can become familiar with the appliance and safety warnings.

### Legend



#### Warning – Important Safety information



General information and tips



Environmental information

### Disposal



Help protect the environment and human health. Put the packaging in applicable containers to recycle it. Help to recycle waste of electrical and electronic appliances. Do not dispose appliances marked with this symbol with the household waste. Return the product to your local recycling facility or contact your municipal office.



## WARNING!

### Risk of injury or suffocation!

Disconnect the appliance from the mains supply. Cut off the mains cable and dispose of it. Remove the door catch to prevent children and pets to get closed in the appliance.

- 1-Safety information..... 4
- 2-Product description ..... 7
- 3-Control panel ..... 8
- 4-Programmes ..... 11
- 5-Consumption..... 12
- 6-Daily use ..... 13
- 7-Eco-friendly washing ..... 18
- 8-Care and cleaning ..... 19
- 9-Troubleshooting ..... 22
- 10-Installation..... 25
- 11-Technical data..... 29
- 12-Customer service..... 31

**Before switching on the appliance for the first time read the following safety hints!:**



## **WARNING!**

### **Before first use**

- ▶ Make sure there is no transport damage.
- ▶ Make sure all transport bolts are removed.
- ▶ Remove all packaging and keep out of children's reach.
- ▶ Handle the appliance always with at least two persons because it is heavy.

### **Daily use**

- ▶ This appliance can be used by children aged from 8 years and above and persons with reduced physical, sensory or mental capabilities or lack of experience and knowledge if they have been given supervision or instruction concerning use of the appliance in a safe way and understand the hazards involved.
- ▶ Keep away children under 3 years of age from the appliance unless they are constantly supervised.
- ▶ Children shall not play with the appliance.
- ▶ Do not let children or pets come close to the appliance when the door is open.
- ▶ Store washing agents out of reach of children.
- ▶ Pull up zips, fix loose threads and take care for small items to prevent laundry from being entangled. If necessary, use an appropriate bag or net.
- ▶ Do not press or use the appliance when barefoot or with wet or damp hands or feet.
- ▶ Do not cover or encase the appliance during operation or afterwards to allow any moisture or dampness to evaporate.
- ▶ Do not place heavy objects or sources of heat or damp on top of the appliance.
- ▶ Do not use or store flammable detergent or dry cleaning agent in close vicinity to the appliance.
- ▶ Do not use any flammable sprays in close vicinity to the appliance.
- ▶ Do not wash any garments treated with solvents in the appliance without having dried them previously in the air.



## WARNING!

### Daily use

- ▶ Do not remove or insert the plug in the presence of flammable gas
- ▶ Do not hot wash foam rubber or sponge-like materials.
- ▶ Do not wash any laundry which is polluted with flour.
- ▶ Do not open detergent drawer during any wash cycle.
- ▶ Do not press the door during the washing process, it gets hot.
- ▶ Do not open the door if the water level is visibly over the porthole.
- ▶ Do not force the door to open. The door is fitted with a self-lock device and will open shortly after the washing procedure is ended.
- ▶ Switch off the appliance after each wash programme and before undertaking any routine maintenance and disconnect the appliance from the electrical supply to save electricity and for safety.
- ▶ Hold the plug, not the cable, when unplugging the appliance.

### Maintenance / cleaning

- ▶ Make sure children are supervised if they carry out cleaning and maintenance.
- ▶ Disconnect the appliance from the electrical supply before undertaking any routine maintenance.
- ▶ Keep the lower part of the porthole clean and open door and detergent drawer if appliance is not in use to prevent odours.
- ▶ Do not use water spray or steam to clean the appliance.
- ▶ Replace a damaged supply cord only by the manufacturer, its service agent or similarly qualified persons in order to avoid a hazard.
- ▶ Do not try to repair the appliance by yourself. In case of repair please contact our customer service.

### Installation

- ▶ The appliance should be placed in a well-ventilated place. Ensure a location which allows opening the door fully.
- ▶ Never install the appliance outdoors in a damp place, or in an area which may be prone to water leaks such as under or near a sink unit. In the event of a water leak cut power supply and allow the machine to dry naturally.



## WARNING!

### Installation

- ▶ Install or use the appliance only where the temperature is above 5 °C.
- ▶ Do not place the appliance directly on a carpet, or close to a wall or furniture.
- ▶ Do not install the appliance in direct sunlight or in the near of heat sources(e.g. stoves, heaters).
- ▶ Make sure that the electrical information on the rating plate agrees with the power supply. If it does not, contact an electrician.
- ▶ Do not use multi-plug adapters and extension cables.
- ▶ Make sure only the delivered electric cable and hose set are used.
- ▶ Make sure not to damage the electric cable and the plug. If damaged have it replaced by an electrician.
- ▶ Use a separate earthed socket for the power supply which is easy accessible after installation. The appliance must be earthed.  
**Only for UK:** The appliance's power cable is fitted with 3-cord (grounding) plug that fits a standard 3-cord (grounded) socket. Never cut off or dismount the third pin (grounding). After the appliance is installed, the plug should be accessible.
- ▶ Make sure the hose joints and connections are firm and there is no leakage.

### Intended use

This appliance is intended for washing machine-washable laundry only. Anytime follow the instructions given on the label of each garment label. It is designed exclusively for domestic use inside the house. It is not intended for commercial or industrial use.

Changes or modifications to the device are not allowed. Unintended use may cause hazards and loss of of all warranty and liability claims.

**i Note:**

Due to technical changes and different models, the illustrations in the following chapters may differ from your model.

## 2.1 Picture of appliance

Front (Fig. 2-1):

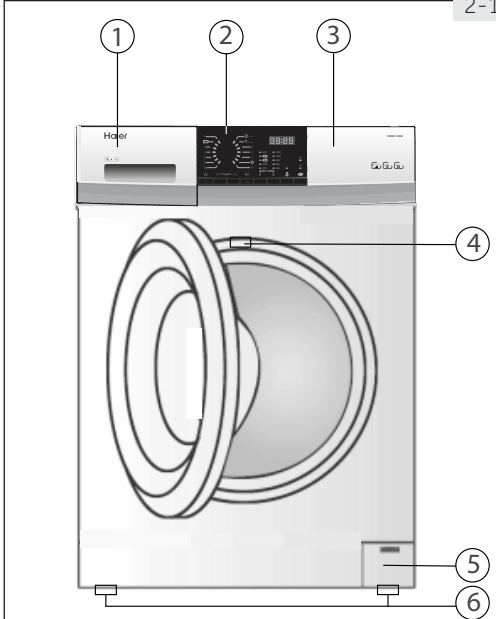

- 1 Detergent /Softener drawer
- 2 Control panel
- 3 Worktop
- 4 Rating plate
- 5 Service flap
- 6 Adjustable feet

Rear side (Fig. 2-2):

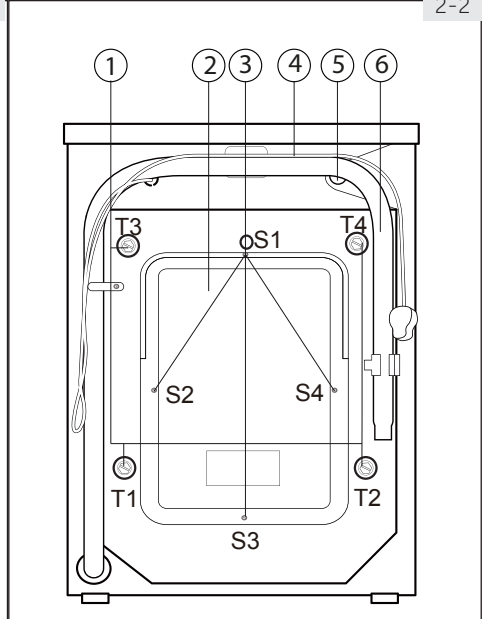

- 1 Transportation bolts (T1-T4)
- 2 Back cover
- 3 Back cover screws (S1-S4)
- 4 Power cord
- 5 Water inlet valve
- 6 Drain hose

## 2.2 Accessories

Check the accessories and literature in accordance with this list (Fig.:2-3):

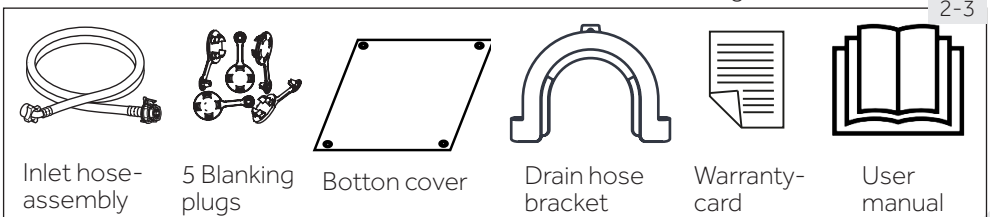

Inlet hose-assembly

5 Blanking plugs

Bottom cover

Drain hose bracket

Warranty-card

User manual

3-0

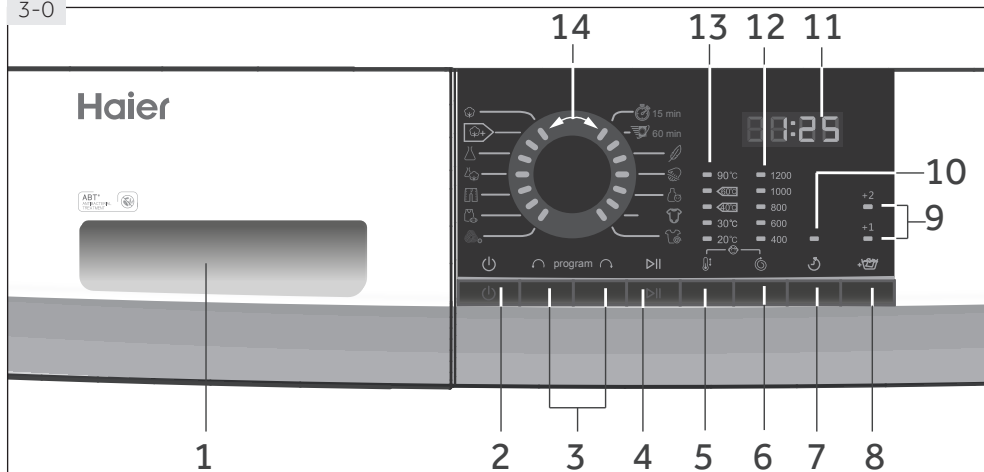

- 1 Detergent /Softener drawer
- 2 "Power" button
- 3 Programme selector
- 4 "Start/Pause" button

**Function buttons:**

- 5 "Temperature"
- 6 "Spin speed"
- 7 "Delay"
- 8 "Extra rinse"

**Indicators:**

- 9 Extra rinse indicator
- 10 Delay indicator
- 11 Display
- 12 Spin speed indicator
- 13 Temperature indicator
- 14 Programme indicator

**Note : Acoustic signal**

In following cases an acoustic signal sounds:

- ▶ when pressing a button
- ▶ at the end of programme
- ▶ in case of failures

The acoustic signal can be deselected if necessary ; see DAILY USE.

3-1

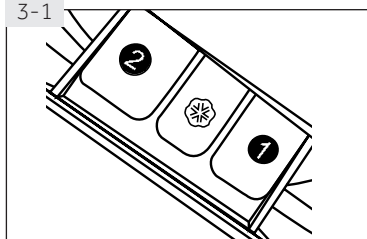

**3.1 Detergent drawer**

Open the drawer, three compartments can be seen (Fig. 3-1):

- Compartment 1 : Water inlet only, no detergent
- Compartment 2 : Detergent for programme
- Compartment : Softener, Conditioning agent etc.

The recommendation on the type of detergents is suitable for the various washing temperatures, please refer to the manual of detergent.



### 3.2 "Power" button

Press this button (Fig. 3-2) gently to switch on, the display is shining. Press it again for about 2 seconds to switch off. If no panel element or programme is activated after a while machine will shut down automatically.

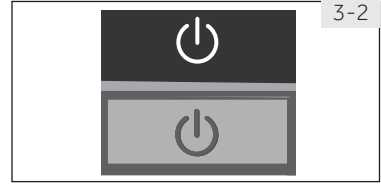

### 3.3 Programme selector

Press one of these buttons (Fig. 3-3) sequentially until the indicator of the desired programme lights up, and the default settings are displayed.

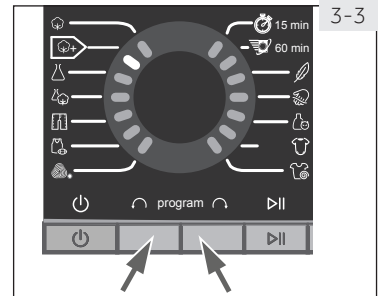

### 3.4 "Start/Pause" button

Press this button (Fig. 3-4) gently to start or interrupt the currently displayed programme. During programme interruption the digits on the display are blinking.



### 3.5 Function buttons

The function buttons (Fig. 3-5) enables additional options in the selected programme before programme start. The related indicators are displayed.

By switching off the appliance or setting a new programme, all options are disabled.

If a button has multiple options, the desired option can be selected by pressing the button sequentially.

To delete the setting or to cancel the setting process, press the function button until the desired LED lights or -in case of only one option- the LED switches off.

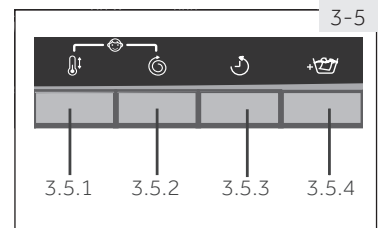

#### Note: Factory settings

To get best results in each programme Haier has well defined specific default settings. If there is no special requirement default settings are recommended.

#### 3.5.1-Function button "Temperature"

Press this button (Fig. 3-5.1) to change the washing temperature of the programme. If no value is illuminated the water will not be heated.

In conjunction with the  "Spin speed" button, the child lock function can be switched on/off (see CHILD LOCK).

#### 3.5.2-Function button "Spin speed"

Press this button (Fig. 3-5.2) to change or deselect the spin of the programme. If no value is illuminated the laundry will not be spun.

In conjunction with the  "Temperature" button, the child lock function can be switched on/off (see CHILD LOCK).

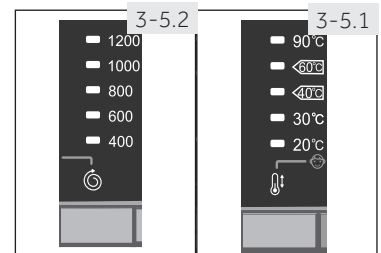

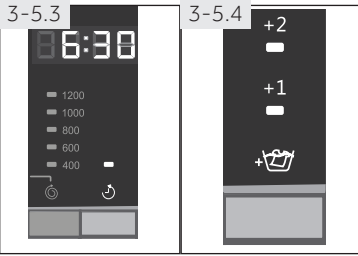

### 3.5.3-Function button "Delay"

Press this button (Fig. 3-5.3) to start the programme with a delay. End time delay could be increased in steps of 30 minutes from 0,5-24h. For example display off **6:30** means end of programme cycle will be in 6 hours and 30 minutes. Press "Start/Pause" button to activate the time delay. It is not applicable to programme COTTON + and SPIN.

### Note: Liquid detergent

If using liquid detergent, it is not recommended to activate the end time delay.

### 3.5.4-Function button "Extra rinse"

Press this button (Fig. 3-5.4) to rinse the laundry more intense with fresh water. This is recommended for people with sensitive skin. One or two additional rinse cycles are available.

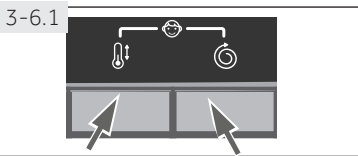

### 3.6 Child lock

Press button „Temperature“ and "Spin speed" (Fig. 3-6.1) for 3 seconds simultaneously to block all panel elements against activation. For unlocking please press again the two buttons.



The display shows (Fig. 3-6.2) if a button will be pressed, when the child lock is activated. The change is not running.

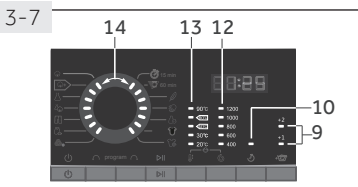

### 3.7 Indicators

The indicators mentioned in figure 3-7 light up when corresponding function/programme is activated.



### 3.8 Display

The display (Fig. 3-8) shows following information:

- ▶ Washing time
- ▶ End time delay
- ▶ Error codes and service information

Detergent compartment for:

- ❶ Water inlet only, **no detergent**
- ❷ Detergent
- ☼ Softener or care product

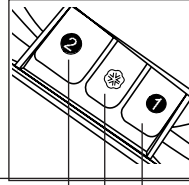

● Yes, ○ Optional, / No

Programme	Max. load in kg <sup>1)</sup> HW60/ HW70/	Temperature in °C <sup>2)</sup> selectable range	Preset				Fibre type	Preset spin speed in rpm
				2	☼	1		
Cotton	6.0/7.0	* to 90	30	●	○	/	Cotton	1000
Cotton +	6.0/7.0	40 to 60	40	●	○	/	Cotton; standard programme for Energy Labelling	1200
Synthetic	3.0/3.5	* to 60	30	●	○	/	Synthetic or mixed fabric	1000
Mix	3.0/3.5	* to 60	30	●	○	/	Lightly soiled mixed-laundry of cotton and synthetic	1000
Jeans	3.0/3.5	* to 60	30	●	○	/	Jeans	1000
Sport	3.0/3.5	* to 40	20	●	○	/	Sports wear	800
Wool	1.0	* to 40	*	●	○	/	Machine-washable fabric made of wool or with wool content	800
15 min Express 15 min <sup>3)</sup>	3.0/3.5	* to 40	*	●	○	/	Cotton / Synthetic	1000
60 min Fast <sup>3)</sup>	3.0/3.5	* to 40	40	●	○	/	Lightly soiled laundry made of cotton or synthetic	1000
Delicate/Silk	1.5/1.75	* to 30	30	●	○	/	Delicate laundry and silk	400
Hand Wash	1.5/1.75	* to 30	30	●	○	/	Laundry marked with symbol for handwash	800
Hygienic	3.0/3.5	90	90	●	○	/	Cotton	1000
Babycare	3.0/3.5	* to 90	40	●	○	/	Cotton/Synthetic	1000
Spin	6.0/7.0	/	/	/	/	/	all fabrics	1000

<sup>1)</sup> Relating to dry laundry.

<sup>2)</sup> \*: water will not heated (no value is illuminated).





Choose 90 °C wash temperature only for special hygienic requirements

<sup>3)</sup> Reduce detergent amount because programme duration is short.



# 5-Consumption



GB

The indicated consumption values may accordingly differ to local conditions.

Programme	Temperature in °C	Max. load in kg	Energy in kWh	Water in L	Washing time in h:min	Spin drying perform- ance in %
		HW60/HW70	HW60/HW70	HW60/HW70	HW60/HW70	
 *		3.0/3.5	0.55/0.63	31.1/37.5	3:43	53
		3.0/3.5	0.71/0.91	29.4/37.4	3:45	53
		6.0/7.0	0.66/0.78	37.6/45.0	3:45	53
	30	3.0/3.5	/	/	/	49

\* Standard programme for the Energy Labelling according to 2010/30 EU:

 Cotton +  / .

The standard  and  cotton programmes are suitable to clean normally soiled cotton laundry. They are the most efficient programmes in terms of combined energy and water consumption for cotton laundry. Used water temperature may differ from declared cycle temperature.

### 6.1 Power supply

Connect the washing machine to a power supply (220V to 240V~/50Hz; Fig. 6-1). Please refer also to section INSTALLATION.

### 6.2 Water connection

- ▶ Before connecting check the cleanliness and clarity of the water inlet.
- ▶ Turn on the tap (Fig.6-2).

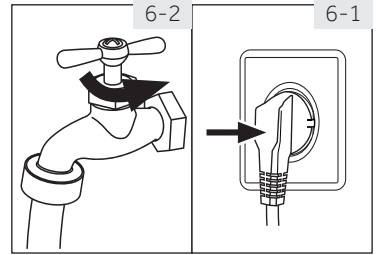

### **i** Note: Tightness

Before use check for leakage in the joints between the tap and the inlet hose by turning on the tap.

### 6.3 Preparing laundry

- ▶ Sort out clothes according to fabric (cotton, synthetics, wool or silk) and to how dirty they are (Fig. 6-3). Pay attention to the care labelling of washing labels.
- ▶ Separate white clothes from coloured ones. Wash coloured textiles first by hand to check if they fade or run.
- ▶ Empty pockets (keys, coins, etc.) and remove harder decorative objects (e.g. brooches).
- ▶ Garments without hems, delicates and finely woven textile such as fine curtains are to be put into a wash bag to care for this delicate laundry (hand or dry cleaning would be better).
- ▶ Close zippers, velco fastener and hooks, make sure the buttons are sewn on tightly.
- ▶ Place sensitive items like laundry without firm hem, delicate underwear (Dessous) and small items such as socks, belts, bras, etc. in a wash bag.
- ▶ Unfold large pieces of fabric such as bed sheets, bedspreads etc.
- ▶ Turn jeans and printed, decorated or color-intensive textiles inside out; possibly wash separately.

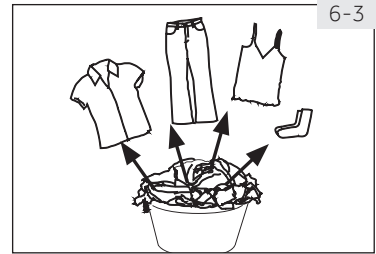

### **!** CAUTION!

Non-textile, as well as small, loose or sharp-edged items may cause malfunctions and damage of clothes and appliance.

## Care chart

Washing		
 Washable up to 95°C normal process	 Washable up to 60°C normal process	 Washable up to 60°C mild process
 Washable up to 40°C normal process	 Washable up to 40°C mild process	 Washable up to 40°C very mild process
 Washable up to 30°C normal process	 Washable up to 30°C mild process	 Washable up to 30°C very mild process
 Wash by hand max. 40°C	 Do not wash	
Bleaching		
 Any bleaching allowed	 Only oxygen/non-chlorine	 Do not bleach
Drying		
 Tumble drying possible normal temperature	 Tumble drying possible lower temperature	 Do not tumble dry
 Line drying	 Flat drying	
Ironing		
 Iron at a maximum temperature up to 200 °C	 Iron at a medial temperature up to 150°C	 Iron at a low temperature up to 110 °C; without steam (steam ironing may cause irreversible damage)
 Do not iron		
Professional Textile Care		
 Dry cleaning in tetra-chloroethene	 Dry cleaning in hydrocarbons	 Do not dry clean
 Professional wet clean	 Do not professional wet clean	







## 6.4 Loading the appliance

- ▶ Put in the laundry piece by piece
- ▶ Don't overload. Note the different maximum load according to programmes! Rule of thumb for maximum load: Check if you can put a hand upright on top of load.
- ▶ Close the door carefully. Make sure that no pieces of laundry are pinched.

## 6.5 Selecting detergent

- ▶ Washing efficiency and performance is determined by used detergent quality.
- ▶ Use only machine wash approved detergent.
- ▶ If needed use specific detergents, e.g. for synthetic and woolen fabric.
- ▶ Mind always detergent manufacturer recommendations.
- ▶ Do not use dry cleaning agents such as trichloroethylene and similar products.

### Choose the best detergent

Programme		Kind of detergent				
		Universal	Colour	Delicate	Special	Softener
	Cotton	L/P	L/P	-	-	o
	Cotton➔	L/P	L/P	-	-	o
	Synthetic	L/P	L/P	L	-	o
	Mix	L/P	L/P	-	-	o
	Jeans	L/P	L/P	L	-	o
	Sport	-	-	-	L	o
	Wool	-	-	-	L	o
	Express 15 min	L	L	-	-	o
	Fast	L	L	-	-	o
	Delicate/Silk	-	-	L	-	o
	Hand Wash	-	-	-	L	o
	Hygienic	L/P	L/P	L	-	o
	Baby Care	L/P	L/P	-	-	o

L = gel-/liquid detergent P = powder detergent O = optional - = no

If using liquid detergent, it is not recommended to activate the time delay.

We recommend by using:

- ▶ Laundry powder: 20°C to 90°C\* (best use: 40-60°C)
- ▶ Color detergent: 20°C to 60°C (best use: 30-60°C)
- ▶ Wool/delicate detergent: 20°C to 30°C (= best use:)

\* Choose 90 °C wash temperature only for special hygienic requirements.

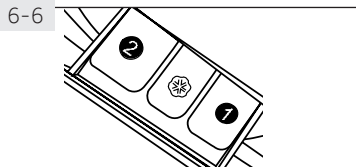

## 6.6 Adding detergent

1. Slide out the detergent drawer.
2. Put the required chemicals into corresponding compartments (Fig. 6-6)
3. Push back the drawer gently.

### **i** Note:

- ▶ Remove detergent residues before next wash cycle from the detergent drawer.
- ▶ Do not overuse detergent or softener.
- ▶ Please follow the instruction on the detergent package.
- ▶ Always fill the detergent just before the beginning of the wash cycle.
- ▶ Concentrated liquid detergent should be diluted before adding into compartment 2.
- ▶ The best use of liquid detergent is by using a dosing ball, which is given with the laundry into the washing machine.
- ▶ Do not use liquid detergent if „end time delay“ is selected.
- ▶ Carefully choose the programme settings according to the care symbols on all laundry labels and according to the programme table.

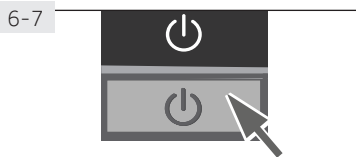

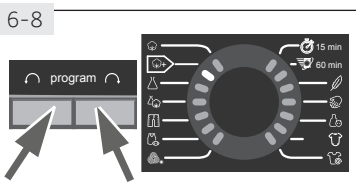

## 6.7 Switch on the appliance

Press the  "Power"- button to switch on the appliance (Fig. 6-7). The Display is shining.



## 6.8 Select a programme

To get the best washing results, select a programme which fits the degree of soiling and sort of laundry type.

Press button  or  (Fig. 6-8) sequentially until the indicator of the desired programme lights up, and the default settings are displayed.

### **i** Note: Odour removal

Before first use we recommended to run programme  HYGIENIC with no load and small amount of detergent in washing agent compartment (2) or special machine cleaner to remove possibly corruptive residues.

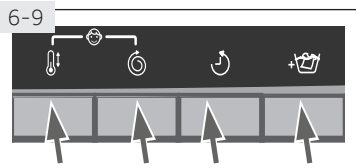

## 6.9 Add individual selections

Select required options and settings (Fig. 6-9); refer to CONTROL PANEL.



### 6.10 Start wash programme



Press  "Start/Pause" button (Fig. 6-10) to start. Appliance operates according to present settings. Changes are only possible by cancelling the programme.



### 6.11 Interrupt - cancel wash programme

To interrupt a running programme press gently  "Start/Pause". The LED in the button is flashing. Press it again to resume operation.

To cancel a running programme and all its individual settings

1. Press  "Start/Pause" button to interrupt the running programme.
2. Press „Power" button for about 2 seconds to switch the appliance off.
3. Run programme  SPIN and select "no Speed" (all lights are off) to drain the water.
4. Select a new programme and start it.

### 6.12 After washing



#### Note: Door lock

- ▶ For safety reasons the door is locked partially during the washing cycle. It is only possible to open the door at the end of the programme or after the programme was cancelled correctly (see description above).
- ▶ In case of high water level, high water temperature and during spinning it is not possible to open the door; **L o c k** is displayed

1. At programme cycle end **End** is displayed.
2. The appliance switches off automatically.
3. Remove laundry as soon as possible to go easy on it and to prevent more wrinkling.
4. Turn off the water supply.
5. Unplug the power cord.
6. Open the door to prevent formation of moisture and odours. Let it open while not used.





#### Note: Standby mode / energy-saving mode

The switched on appliance will go into standby-mode if it will not be activated within 2 minutes before starting the program or at the end of program. The display switches off. This saves energy. To interrupt the standby mode push "Start/Pause" button.

### 6.13 Activate or deactivate the buzzer

The acoustic signal can be deselected if necessary:

1. Switch on the appliance.
2. Select the  SPIN programme.
3. Press the  "Delay" button and  "Spin speed" button at the same time for about three seconds. **bEEP OFF** will be displayed and the buzzer will be deactivated.

For activating the buzzer press these two buttons at the same time again. **bEEP On** will be displayed.



## Environmentally responsible use

- ▶ To achieve best use of energy, water, detergent and time you should use the recommended maximum load size.
- ▶ Do not overload (hand width clearance above laundry).
- ▶ For slightly soiled laundry select the Quick Wash programme.
- ▶ Apply exact dosages of each washing agent.
- ▶ Choose the lowest adequate washing temperature - modern detergents are efficiently cleaning below 60°C.
- ▶ Raise default settings only due to heavy staining.
- ▶ Select max. spinning speed if a domestic dryer is used.

### 8.1 Cleaning the detergent drawer

Take always care there are no detergent residues. Clean the drawer regularly (Fig. 8-1):

1. Pull out the drawer until it stops.
2. Press the release button and remove the drawer.
3. Flush the drawer with water until it is clean and insert the drawer back in the appliance.

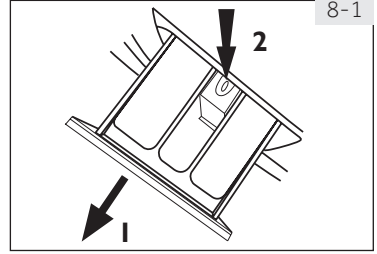

### 8.2 Cleaning the machine

- ▶ Unplug the machine during cleaning and maintenance.
- ▶ Use a soft cloth with soap liquid to clean the machine case (Fig. 8-2) and rubber components.
- ▶ Do not use organic chemicals or corrosive solvents.



### 8.3 Water inlet valve and inlet valve filter

To prevent blockage of water supply by solid substances like lime clean regularly the inlet valve filter.

- ▶ Unplug the power cord and turn off the water supply.
- ▶ Unscrew the water inlet hose at the back (Fig. 8-3.1) of the appliance as well as on the tap (Fig. 8-3.2).
- ▶ Remove the filters and flush them with water and a brush.
- ▶ Insert the filter and install the inlet hose.

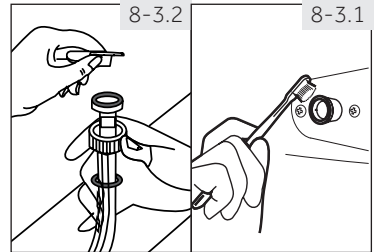

### 8.4 Cleaning the drum

- ▶ Remove accidentally washed metal parts such as pins, coins, etc. from the drum (Fig. 8-4) because they cause rust stains and damage.
- ▶ Use a non-chloride cleaner for removing rust stains. Observe the warning hints of the cleaning agent manufacturer.
- ▶ Do not use any hard objects or steel wool for cleaning.

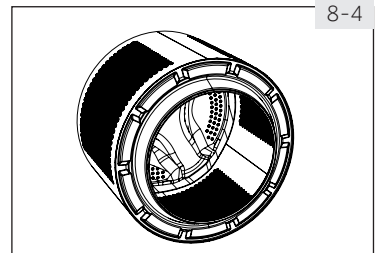

### Note: Hygiene

For regular maintenance we recommend to run programme  HYGIENIC with no load in order to remove possible corruptive residues quarterly. Add a small amount of detergent in washing agent compartment (2) - or use a special machine cleaner

8-5.1

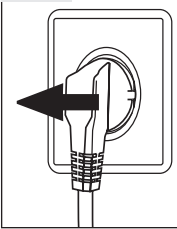

8-5.2

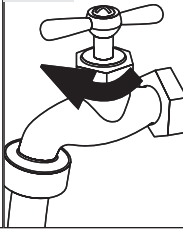

## 8.5 Long periods of disuse

If the appliance is left idle for a longer period:

1. Pull out the electrical plug (Fig. 8-5.1).
2. Turn off water supply (Fig. 8-5.2).
3. Open the door to prevent formation of moisture and odours. Let door open while not used.

Before next usage check carefully power cord, water inlet and drain hose. Make sure everything is properly installed and without leakage.



### Note: Hygiene

After long periods of disuse we recommended to run programme  HYGIENIC with no load and small amount of detergent in washing agent compartment (2) or special machine cleaner to remove possibly corruptive residues.

8-6.1

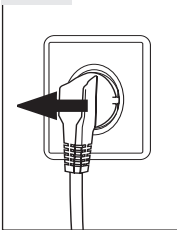

8-6.2

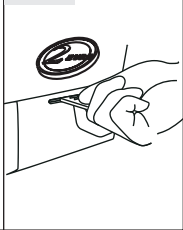

## 8.6 Pump filter

Clean the filter once a month and check the pump filter for instance if the appliance:

- ▶ doesn't drain the water.
- ▶ doesn't spin.
- ▶ cause unusual noise while running.



### WARNING!

Scalding Risk! Water in the pump filter can be very hot! Before any action please ensure water has cooled down.

8-6.3

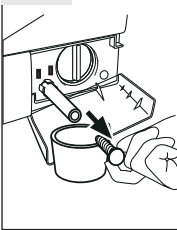

8-6.4

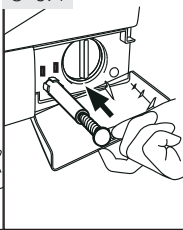

1. Turn off and unplug the machine (Fig. 8-6.1).
2. Open service flap. You can either use a coin or a screwdriver (Fig. 8-6.2).
3. Provide a flat container to catch leach water (Fig. 8-6.3). There could be bigger amounts!
4. Pull the drainhose out and hold its end above the container (Fig. 8-6.3).
5. Take the sealing plug out of the drainhose (Fig. 8-6.3).
6. After complete drainage close drainhose (Fig. 8-6.4) and push it back into the machine.
7. Unscrew and remove counter clockwise the pump filter (Fig. 8-6.5).
8. Remove contaminants and dirt (Fig. 8-6.6).

8-6.5

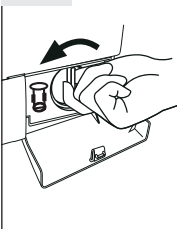

8-6.6

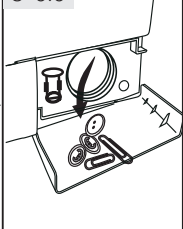

9. Clean carefully pump filter, e.g. using running water (Fig. 8-6.7).
10. Refix it thoroughly (Fig. 8-6.8).
11. Close service flap.

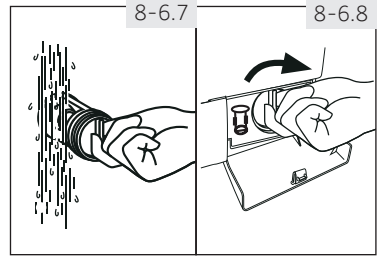
**CAUTION!**

- ▶ Pump filter sealing has to be clean and unhurt. If the lid is not full tightened, water can escape.
- ▶ The filter must be in place, or it may lead to leakage.

Many occurring problems could be solved by yourself without specific expertise. In case of a problem please check all shown possibilities and follow below instructions before you contact an after sales service. See CUSTOMER SERVICE.



## WARNING!

- ▶ Before maintenance, deactivate the appliance and disconnect the mains plug from the mains socket.
- ▶ Electrical equipment should be serviced only by qualified electrical experts, because improper repairs can cause considerable consequential damages..
- ▶ A damaged power cable should only be replaced by the manufacturer, its service agent or similarly qualified persons in order to avoid a hazard.

### 9.1 Information codes

Following codes are displayed only for information referring to the washing cycle. No measures must be performed.

Code	Message
<i>1:25</i>	The remaining wash cycle time will be 1 hour and 25 minutes.
<i>6:30</i>	The remaining wash cycle time including chosen end-time delay will be 6 hours and 30 minutes.
<i>End</i>	The washing cycle is finished. The appliance shuts off automatically.
<i>cLo t</i>	Function child lock is activated.
<i>LoCl-</i>	Door is closed because of high water level, high water temperature or spinning cycle.
<i>bEEP OFF</i>	The buzzer is deactivated.
<i>bEEP On</i>	The buzzer is activated.

### 9.2 Troubleshooting with display code

Problem	Cause	Solution
<i>E 1</i>	<ul style="list-style-type: none"> <li>• Drainage error, water is not fully drained within 6 minutes.</li> </ul>	<ul style="list-style-type: none"> <li>• Clean pump filter.</li> <li>• Check drain hose installation.</li> </ul>
<i>E2</i>	<ul style="list-style-type: none"> <li>• Lock - error.</li> </ul>	<ul style="list-style-type: none"> <li>• Shut the door properly.</li> </ul>
<i>E4</i>	<ul style="list-style-type: none"> <li>• Water level not reached after 10 minutes. at the latest.</li> <li>• Drain hose is self-syphoning.</li> </ul>	<ul style="list-style-type: none"> <li>• Make sure that tap is fully opened and water Pressure is normal.</li> <li>• Check drain hose installation.</li> </ul>
<i>EB</i>	<ul style="list-style-type: none"> <li>• Water protective level - error.</li> </ul>	<ul style="list-style-type: none"> <li>• Contact the After sales service.</li> </ul>
<i>F3</i>	<ul style="list-style-type: none"> <li>• Temperature sensor - error.</li> </ul>	<ul style="list-style-type: none"> <li>• Contact the After sales service.</li> </ul>
<i>F4</i>	<ul style="list-style-type: none"> <li>• Heating error.</li> </ul>	<ul style="list-style-type: none"> <li>• Contact the After sales service.</li> </ul>

Problem	Cause	Solution
F7	<ul style="list-style-type: none"> <li>Motor - error.</li> </ul>	<ul style="list-style-type: none"> <li>Contact the After sales service.</li> </ul>
FE0, FE1 or FE2	<ul style="list-style-type: none"> <li>Abnormal communication error.</li> </ul>	<ul style="list-style-type: none"> <li>Contact the After sales service.</li> </ul>
Unb	<ul style="list-style-type: none"> <li>Unbalanced load - error.</li> </ul>	<ul style="list-style-type: none"> <li>Check and balance laundry load in the drum. Reduce the load.</li> </ul>

### 9.3 Troubleshooting without display code

Problem	Cause	Solution
Washing machine fails to operate.	<ul style="list-style-type: none"> <li>Programme is not yet started.</li> <li>Door is not properly closed.</li> <li>Machine has not been switched on.</li> <li>Power failure.</li> <li>Child lock is activated.</li> </ul>	<ul style="list-style-type: none"> <li>Check programme and start it.</li> <li>Close the door properly.</li> <li>Switch the machine on.</li> <li>Check power supply.</li> <li>Deactivate child lock.</li> </ul>
Washing machine will not be filled with water.	<ul style="list-style-type: none"> <li>No water.</li> <li>Inlet hose is kinked.</li> <li>Inlet hose filter is blocked.</li> <li>Water pressure is less than 0.03 MPa.</li> <li>Door is not properly closed.</li> <li>Water supply failure.</li> </ul>	<ul style="list-style-type: none"> <li>Check water tap.</li> <li>Check inlet hose.</li> <li>Unblock inlet hose filter.</li> <li>Check water pressure.</li> <li>Close the door properly.</li> <li>Ensure the water supply.</li> </ul>
Machine is draining while being filled.	<ul style="list-style-type: none"> <li>Height of drain hose is below 80 cm.</li> <li>Drain hose end could reach into water.</li> </ul>	<ul style="list-style-type: none"> <li>Make sure that drain hose is properly installed.</li> <li>Make sure the drain hose is not in water.</li> </ul>
Drainage failure.	<ul style="list-style-type: none"> <li>Drain hose is blocked.</li> <li>Pump filter is blocked.</li> <li>Drain hose end is higher than 100 cm above floor level.</li> </ul>	<ul style="list-style-type: none"> <li>Unblock drain hose.</li> <li>Clean pump filter.</li> <li>Make sure that drain hose is properly installed.</li> </ul>
Strong vibration while spinning.	<ul style="list-style-type: none"> <li>Not all transportation bolts have been removed.</li> <li>Appliance has no solid position.</li> <li>Machine load is not correct.</li> </ul>	<ul style="list-style-type: none"> <li>Remove all transportation bolts.</li> <li>Ensure solid ground and a levelled position.</li> <li>Check load weight and balance.</li> </ul>
Operation stops before completing wash cycle.	<ul style="list-style-type: none"> <li>Water or electric failure.</li> </ul>	<ul style="list-style-type: none"> <li>Check power and water supply.</li> </ul>
Operation stops for a period of time.	<ul style="list-style-type: none"> <li>Appliance displays error code.</li> <li>Problem due to load pattern.</li> <li>Programme performs soaking cycle.</li> </ul>	<ul style="list-style-type: none"> <li>Consider display codes.</li> <li>Reduce or adjust load.</li> <li>Cancel programme and restart.</li> </ul>
Excessive foam floats drum and/or detergent drawer.	<ul style="list-style-type: none"> <li>Detergent is not appropriate.</li> <li>Excessive use of detergent.</li> </ul>	<ul style="list-style-type: none"> <li>Check detergent recommendations.</li> <li>Reduce amount of detergent.</li> </ul>

Problem	Cause	Solution
Automatic adjustment of washing time.	<ul style="list-style-type: none"> <li>Washing programme duration will be adjusted.</li> </ul>	<ul style="list-style-type: none"> <li>This is normal and doesn't affect functionality.</li> </ul>
Spinning fails.	<ul style="list-style-type: none"> <li>Unbalance of laundry.</li> </ul>	<ul style="list-style-type: none"> <li>Check machine load and laundry and run a spinning programme again.</li> </ul>
Unsatisfactory washing result.	<ul style="list-style-type: none"> <li>Degree of pollution does not agree with selected programme.</li> <li>Detergent quantity was not sufficient.</li> <li>Maximum load has been exceeded.</li> <li>Laundry was unevenly distributed in the drum.</li> </ul>	<ul style="list-style-type: none"> <li>Select an other programme.</li> <li>Choose the detergent according to the degree of pollution and according to manufacturer specifications.</li> <li>Reduce loading.</li> <li>Loose the laundry.</li> </ul>
Washing powder residues are on the laundry.	<ul style="list-style-type: none"> <li>Insoluble particles of detergent can remain as white spots on the laundry.</li> </ul>	<ul style="list-style-type: none"> <li>Perform extra rinse.</li> <li>Try to brush the points from the dry laundry.</li> <li>Choose an other detergent.</li> </ul>
Laundry has grey patches.	<ul style="list-style-type: none"> <li>Caused by fats such as oils, creams or ointments.</li> </ul>	<ul style="list-style-type: none"> <li>Pretreat the laundry with a special cleaner.</li> </ul>

## Note: Foam formation

If too much foam is inspected during spin cycle, motor stops and drain pump will be activated for 90 seconds. If that elimination of foam fails up to 3 times, programme ends without spinning.

Should the error messages reappear even after the taken measures, switch off the appliance, disconnect the power supply and contact the customer service.

9-4

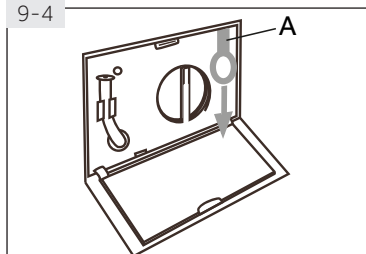

## 9.4 In case of power failure

The current programme and its setting will be saved. When power supply is restored operation will be resumed.

In case of power failure during programme run door opening is mechanically blocked. If the laundry is to be removed, the water level must not be visible in the glass door. - Danger of scalding!

- ▶ Lower the water level according to step 1 to 6 of chapter CARE AND CLEANING (PUMP FILTER).
- ▶ Pull lever (A) beneath service flap (Fig. 9-4) until door is unlocked by a gentle click.
- ▶ Fix all parts and close the service flap.



## 10.1 Preparation

- ▶ Take the appliance out of the packaging.
- ▶ Remove all packaging material including polystyrene base, keep them out of children's reach. While opening the package, water drops may be seen on plastic bag and port-hole. This normal phenomenon results from water tests in the factory.



### Note: Packaging disposal

Keep all packaging materials out of children's reach and dispose them in an environmentally friendly manner.

## 10.2 Adjusting the bottom cover board

When opening the shrink package, you will find a calcium-plastic board (Fig. 10-2.1). The board is used for reducing noise after covering the bottom of the cabinet.

1. Lay the washing machine down to its side, port-hole pointing upwards, bottom side towards operator and screw off the four bolts (Fig. 10-2.2).
2. Place the calcium-plastic board, screw the bolts through the four holes on the board on to the tub firmly (Fig. 10-2.3). Finally set the machine upright again.

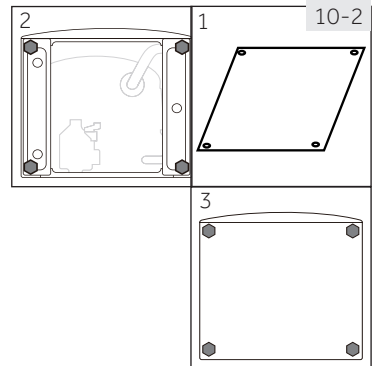

## 10.3 Dismantle the transportation bolts

The transportation bolts are designed for clamping anti-vibration components inside the appliance during transportation to prevent inner damage.

1. Remove the back cover (Fig. 10-3.1).
2. Remove all 4 bolts on the rear side and take out plastic spacers (A) from inner side of the machine (Fig. 10-3.2).
3. Replace back cover by inserting it in the two gaps its convexity is facing out (Fig. 10-3.3).
4. Fill left holes with blanking plugs (Fig. 10-3.4).

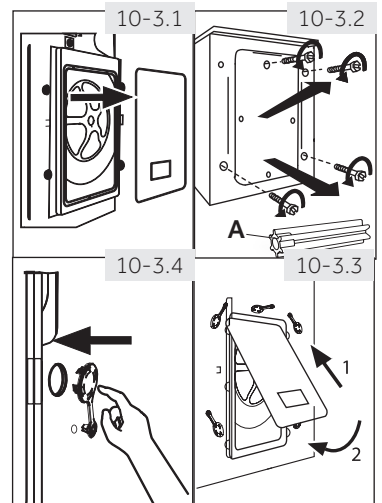

### Note: Keep in safe place

Keep the transportation bolts in a safe place for later use. Whenever the appliance is to be moved at first reinstall the bolts.

## 10.4 Moving the appliance

If the machine is to be moved to a distant location, replace the transportation bolts removed before installation to prevent damage:

1. Remove the blanking plugs.
2. Remove the back cover
3. Insert the plastic spacers and the transportation bolts.
4. Tighten the bolts with a spanner.
5. Replace the back cover.

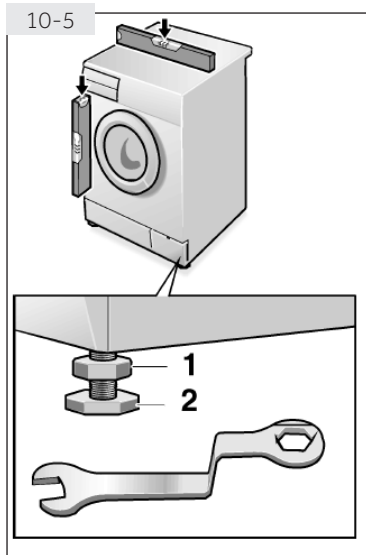

## 10.5 Aligning the appliance

Adjust all feet (Fig. 10-5) to achieve a complete level position. This will minimize vibrations and thus noise during use. It will also reduce wear and tear. We recommend to use a spirit level for adjustment. Floor should be as stable and flat as possible.

1. Loose the locknut (1) by using a wrench.
2. Adjust the high by turning the foot (2).
3. Tighten locknut (1) against the housing.

## 10.6 Drain Water Connection

Fix the water drain hose properly to the piping. The hose has to reach at one point a height between 80 and 100 cm above the appliance bottom line! If possible keep always drain hose fixed to the clip at the appliance back.



### WARNING!

- ▶ Use only the supplied hose set for the connection.
- ▶ Never reuse old hose sets!
- ▶ Only connect to cold water supply.
- ▶ Before connection, check whether the water is clean and clear.

Following connections are possible:

### 10.6.1 Drain hose to sink

- ▶ Hang the drain hose with the U-support over the edge of a sink with adequate size (Fig. 10-6.1).
- ▶ Protect the U-support sufficiently against slipping.

### 10.6.2 Drain hose to waste water connection

- ▶ The internal diameter of the stand pipe with vent-hole must be minimum 40 mm.
- ▶ Put the drain hose for approx. 80 mm in the wastewater pipe.
- ▶ Attach the U-support and secure it sufficiently (Fig. 10-6.2).

### 10.6.3 Drain hose to sink connection

- ▶ The junction must lie above the siphon
- ▶ A spigot connection is usually closed by a pad (A). That must be removed to prevent any disfunction (Fig. 10-6.3).
- ▶ Secure the drain hose with a clamp.

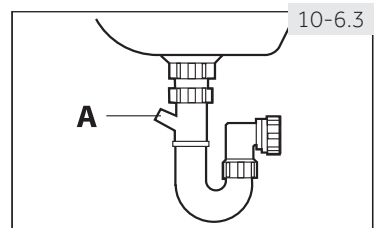
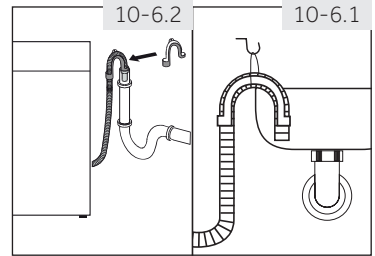

## CAUTION!

- ▶ The drain hose should not be submerged in water and should be securely fixed and leak-free. If the drain hose is placed on the ground or if the pipe is at a height of less than 80 cm, the washing machine will continuously drain while being filled (self-siphoning).
- ▶ Drain hose is not to be extended. If necessary contact after sales service.

## 10.7 Fresh Water Connection

Make sure that the gaskets are inserted.

1. Connect the water inlet hose with the angled end to the appliance (Fig. 10-7.1). Tighten the screw joint by hand.
2. The other end connect to a water tap with a 3/4" thread (Fig. 10-7.2).

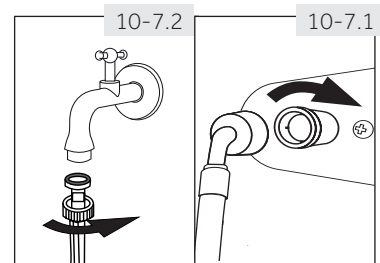

10-8

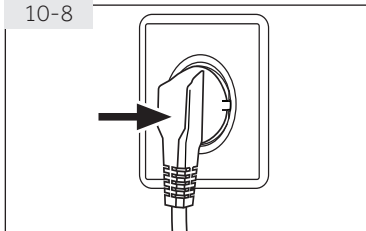

## 10.8 Electrical Connection

Before each connection check if:

- ▶ power supply, socket and fusing are appropriate to the rating plate.
- ▶ the power socket is earthed and no multi-plug or extension are used.
- ▶ the power plug and socket are strictly according.
- ▶ **Only UK:** The UK plug meets BS1363A standard.

Put the plug into the socket (Fig. 10-8).



### WARNING!

- ▶ Ensure always that all connections (power supply, drain and fresh water hose) are firm, dry and leak free!
- ▶ Take care these parts are never to be crushed, kinked, or twisted
- ▶ If the supply cord is damaged, it must be replaced by the service agent (see warranty card) in order to avoid a hazard. .



### Note: Hygiene

After each installation or long periods of disuse, before first use and for regular maintenance run programme  HYGIENIC with no load and small amount of detergent in washing agent compartment (2) or with special machine cleaner to remove possibly corruptive residues.

### 11.1 Product fiche according to regulation EU No. 1061/2010

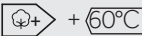
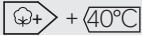
Suppliers name or trade mark	Haier	
Supplier's model identifier	HW60-12829	HW70-12829
Rated capacity (kg)	6	7
Energy efficiency class	A+++	
Energy consumption per year (AE <sub>C</sub> in kWh/year) <sup>1)</sup>	145	174
Energy consumption of standard cotton programme 60 °C, full load (kWh/cycle)	0.66	0.78
Energy consumption of standard cotton programme 60 °C, partial load (kWh/cycle)	0.71	0.91
Energy consumption of standard cotton programme 40 °C, partial load (kWh/cycle)	0.55	0.63
Weighted power consumption of the off mode (W)	0.48	0.44
Weighted power consumption of the left-on mode (W)	0.48	0.52
Water consumption per year (AW <sub>C</sub> in L/year) <sup>2)</sup>	8200	9000
Spin-drying efficiency class <sup>3)</sup>	B	
Max. spin speed (rpm) <sup>4)</sup>	1200/1400	
Remaining moisture content (%) <sup>4)</sup>	53	
Standard 60°C cotton programme <sup>5)</sup>		
Standard 40°C cotton programme <sup>5)</sup>		
Programme time of cotton 60°C full load (min)	225	
Programme time of cotton 60°C partial load (min)	225	
Programme time of cotton 40°C partial load (min)	223	
Duration of the left-on mode (T <sub>i</sub> in min) <sup>6)</sup>	not applicable	
Airborne accustical noise (washing/spinning) in dB(A) re 1pW <sup>7)</sup>	58/78	60/75
Type	freestanding	

- 1) Based on 220 standard washing cycles for cotton programmes at 60°C and 40°C at full and partial load, and the consumption of the low-power modes. Actual energy consumption will depend on how the appliance is used.
- 2) Based on 220 standard washing cycles for cotton programmes at 60 °C and 40 °C at full and partial load. Actual water consumption will depend on how the appliance is used.
- 3) Class G is the least efficiency and Class A is the most efficient.
- 4) Based on the standard 60 °C cotton programme at full load and the standard 40 °C cotton programme at partial load.
- 5) "Standard 60 °C cotton programme" and "standard 40 °C cotton programme" are standard washing programmes to which the information in the label and fiche relates. These programmes are suitable to clean normally soiled cotton laundry and they are the most efficient programmes in terms of combined energy and water consumption.
- 6) In case there is a power management system.
- 7) Based on the standard 60°C cotton programme at full load.

## 11.2 Additional technical data

	HW60-12829	HW70-12829
Dimension in mm	850	
Height	850	
Width	595	
Depth	410	460
Voltage in V	220-240 V~/50Hz	
Current in A	10	
Max power in W	2050	
Water Pressure in MPa	$0.03 \leq P \leq 1$	
Max. water inlettemperatur	cold	
Netto weight in kg	60	64

## 11.3 Standards and Directives

This product meets the requirements of all applicable EC directives with the corresponding harmonised standards, which provide for CE marking.

We recommend our Haier Customer Service and the use of original spare parts.  
If you have a problem with your appliance, please first check section TROUBLESHOOTING.

If you cannot find a solution there, please contact

- ▶ your local dealer or
- ▶ the Service & Support area at [www.haier.com](http://www.haier.com) where you can find telephone numbers and FAQs and where you can activate the service claim.

To contact our Service, ensure that you have the following data available.  
The information can be found on the rating plate.

Model \_\_\_\_\_ Serial No. \_\_\_\_\_

Also check the Warranty Card supplied with the product in case of warranty.

For general business enquiries please find below our addresses in Europe:

European Haier addresses			
Country*	Postal address	Country*	Postal address
<b>Italy</b>	Haier Europe Trading SRL Via De Cristoforis, 12 21100 Verese ITALY	<b>France</b>	Haier France SAS 3-5 rue des Gravieres 92200 Neuilly sur Seine FRANCE
<b>Spain Portugal</b>	Haier Iberia SL Pg. Garcia Faria, 49-51 08019 Barcelona SPAIN	<b>Belgium-FR Belgium-NL Netherlands Luxembourg</b>	Haier Benelux SA Anderlecht Route de Lennik 451 BELGIUM
<b>Germany Austria</b>	Haier Deutschland GmbH Hewlett-Packard-Str. 4 D-61352 Bad Homburg GERMANY	<b>Poland Czechia Hungary Greece Romania Russia</b>	Haier Poland Sp. zo.o. Al. Jerozolimskie 181B 02-222 Warszawa POLAND
<b>United Kingdom</b>	Haier Appliances UK Co.Ltd. One Crown Square Church Street East Woking, Surrey, GU21 6HR UK		

\*For more information please refer to [www.haier.com](http://www.haier.com)

HW-60-70-12829 -EE\_GB\01\_052017

**Haier**

0020506943FU