

IL A1.UK

12NC: F093251

GTIN (EAN) code: 8007842932515

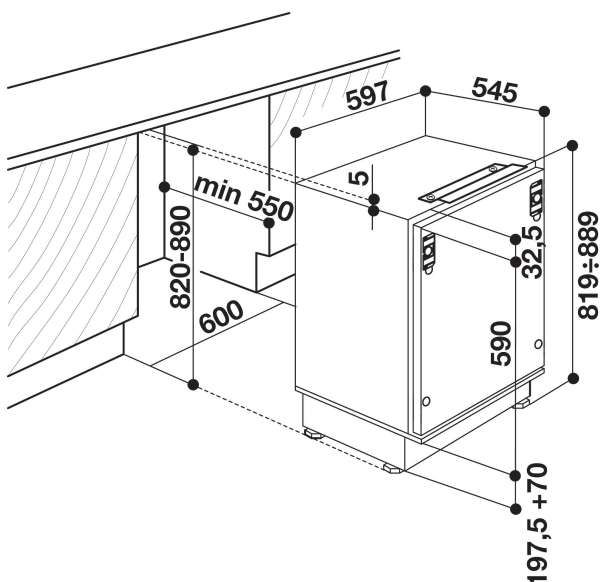

MAIN FEATURES

Product group	Refrigerator
Commercial code	IL A1.UK
GTIN (EAN) code	8007842932515
Construction type	Built-in
Installation type	Built-under
Type of control	Mechanical
Type of control settings	Mechanic
Main colour of product	Steel
Electrical connection rating (W)	100
Current (A)	13
Voltage (V)	220-240
Frequency (Hz)	50
Length of Electrical Supply Cord (cm)	200
Plug type	UK
Total unit net capacity (l)	146
Star Rating	Automatic
Number of independent cooling systems	1
Height of the product	815
Width of the product	596
Depth of the product	545
Depth with open door 90 degree (mm)	-
Maximum adjustability feet	70
Net weight (kg)	32
Door hinge	Right reversible

TECHNICAL FEATURES

Temperature adjustable	Yes
Warning signal / Malfunction	No signal
Defrost process fridge section	Automatic
Fast cooling possibility	No
Interior ventilator fridge section	No
Shelves for Bottles	No
Lockable door	No
Number of shelves in fridge compartment	2
Number of Adjustable Shelves in fridge compartment	2
Material of the shelves	Glass
Thermometer fridge section	None

PERFORMANCES

Energy efficiency class - NEW (2010/30/EU)	A+
Energy consumption annual (kWh/annum) - NEW (2010/30/EU)	118
Refrigerator Net capacity (l) - NEW (2010/30/EU)	146
Freezer Net capacity (l) - NEW (2010/30/EU)	0
Freezing capacity (kg/24h) - NEW (2010/30/EU)	0
Temperature rise time (h)	0
Climate class	SN-ST
Noise level (dB(A) re 1 pW)	37
Frost free system	No
Maximum ambient temperature	0
Minimum ambient temperature	0