

SONY[®]

4-536-323-11(1)

Interchangeable Lens
Digital Camera

α
77II

Instruction Manual

A-mount

ILCA-77M2

English

Learning more about the camera (“Help Guide”)



“Help Guide” is an on-line manual. You can read the “Help Guide” on your computer or smartphone. Refer to it for in-depth instructions on the many functions of the camera.

URL:

http://rd1.sony.net/help/ilc/1410/h_zz/



Owner's Record

The model and serial numbers are located on the bottom. Record the serial number in the space provided below. Refer to these numbers whenever you call your Sony dealer regarding this product.

Model No. ILCA-77M2

Serial No. _____

WARNING

To reduce fire or shock hazard, do not expose the unit to rain or moisture.

IMPORTANT SAFETY INSTRUCTIONS -SAVE THESE INSTRUCTIONS DANGER TO REDUCE THE RISK OF FIRE OR ELECTRIC SHOCK, CAREFULLY FOLLOW THESE INSTRUCTIONS

If the shape of the plug does not fit the power outlet, use an attachment plug adaptor of the proper configuration for the power outlet.

CAUTION

Battery pack

If the battery pack is mishandled, the battery pack can burst, cause a fire or even chemical burns. Observe the following cautions.

- Do not disassemble.
- Do not crush and do not expose the battery pack to any shock or force such as hammering, dropping or stepping on it.
- Do not short circuit and do not allow metal objects to come into contact with the battery terminals.
- Do not expose to high temperature above 60°C (140°F) such as in direct sunlight or in a car parked in the sun.
- Do not incinerate or dispose of in fire.
- Do not handle damaged or leaking lithium ion batteries.
- Be sure to charge the battery pack using a genuine Sony battery charger or a device that can charge the battery pack.
- Keep the battery pack out of the reach of small children.
- Keep the battery pack dry.
- Replace only with the same or equivalent type recommended by Sony.
- Dispose of used battery packs promptly as described in the instructions.

Battery charger

Use the nearby wall outlet (wall socket) when using the Charger. Disconnect the Charger from the wall outlet (wall socket) immediately if any malfunction occurs while using the apparatus.

The power cord (mains lead), if supplied, is designed specifically for use with this camera only, and should not be used with other electrical equipment.

For Customers in the U.S.A. and Canada

RECYCLING LITHIUM-ION BATTERIES

Lithium-Ion batteries are recyclable.

You can help preserve our environment by returning your used rechargeable batteries to the collection and recycling location nearest you.



For more information regarding recycling of rechargeable batteries, call toll free 1-800-822-8837, or visit <http://www.call2recycle.org/>

Caution: Do not handle damaged or leaking Lithium-Ion batteries.

Battery pack and lens (if lens supplied)

This device complies with Part 15 of the FCC Rules. Operation is subject to the following two conditions:

(1) This device may not cause harmful interference, and (2) this device must accept any interference received, including interference that may cause undesired operation.

CAN ICES-3 B/NMB-3 B

This equipment complies with FCC/IC radiation exposure limits set forth for an uncontrolled environment and meets the FCC radio frequency (RF) Exposure Guidelines and RSS-102 of the IC radio frequency (RF) Exposure rules. This equipment has very low levels of RF energy that are deemed to comply without testing of specific absorption ratio (SAR).

For Customers in the U.S.A.

If you have any questions about this product, you may call:

Sony Customer Information Center
1-800-222-SONY (7669).

The number below is for the FCC related matters only.

Regulatory Information

Declaration of Conformity

Trade Name: SONY

Model No.: ILCA-77M2

Responsible Party: Sony Electronics Inc.

Address: 16530 Via Esprillo,
San Diego, CA 92127
U.S.A.

Telephone No.: 858-942-2230

This device complies with Part 15 of the FCC Rules. Operation is subject to the following two conditions: (1) This device may not cause harmful interference, and (2) this device must accept any interference received, including interference that may cause undesired operation.

This equipment must not be co-located or operated in conjunction with any other antenna or transmitter.

CAUTION

You are cautioned that any changes or modifications not expressly approved in this manual could void your authority to operate this equipment.

Note:

This equipment has been tested and found to comply with the limits for a Class B digital device, pursuant to Part 15 of the FCC Rules.

These limits are designed to provide reasonable protection against harmful interference in a residential installation.

This equipment generates, uses, and can radiate radio frequency energy and, if not installed and used in accordance with the instructions, may cause harmful interference to radio communications.

However, there is no guarantee that interference will not occur in a particular installation. If this equipment does cause harmful interference to radio or television reception, which can be determined by turning the equipment off and on, the user is encouraged to try to correct the interference by one or more of the following measures:

- Reorient or relocate the receiving antenna.
- Increase the separation between the equipment and receiver.
- Connect the equipment into an outlet on a circuit different from that to which the receiver is connected.
- Consult the dealer or an experienced radio/TV technician for help.

The supplied interface cable must be used with the equipment in order to comply with the limits for a digital device pursuant to Subpart B of Part 15 of FCC Rules.

For Customers in Canada

This device complies with Industry Canada licence-exempt RSS standard(s).

Operation is subject to the following two conditions: (1) this device may not cause interference, and (2) this device must accept any interference, including interference that may cause undesired operation of the device.

For Customers in Europe

Notice for the customers in the countries applying EU Directives

Manufacturer: Sony Corporation, 1-7-1 Konan Minato-ku Tokyo, 108-0075 Japan
For EU product compliance: Sony Deutschland GmbH, Hedelfinger Strasse 61, 70327 Stuttgart, Germany



Hereby, Sony Corporation, declares that this equipment is in compliance with the essential requirements and other relevant provisions of Directive 1999/5/EC. For details, please access the following URL: <http://www.compliance.sony.de/>

Notice

If static electricity or electromagnetism causes data transfer to discontinue midway (fail), restart the application or disconnect and connect the communication cable (USB, etc.) again.

This product has been tested and found compliant with the limits set out in the EMC regulation for using connection cables shorter than 3 meters (9.8 feet).

The electromagnetic fields at the specific frequencies may influence the picture and sound of this unit.

Disposal of waste batteries and electrical and electronic equipment (applicable in the European Union and other European countries with separate collection systems)



This symbol on the product, the battery or on the packaging indicates that the product and the battery shall not be treated as household waste. On

certain batteries this symbol might be used in combination with a chemical symbol. The chemical symbols for mercury (Hg) or lead (Pb) are added if the battery contains more than 0.0005% mercury or 0.004% lead. By ensuring these products and batteries are disposed of correctly, you will help prevent potentially negative consequences for the environment and human health which could otherwise be caused by inappropriate waste handling. The recycling of the materials will help to conserve natural resources.

In case of products that for safety, performance or data integrity reasons require a permanent connection with an incorporated battery, this battery should be replaced by qualified service staff only. To ensure that the battery and the electrical and electronic equipment will be treated properly, hand over these products at end-of-life to the applicable collection point for the recycling of electrical and electronic equipment. For all other batteries, please view the section on how to remove the battery from the product safely. Hand the battery over to the applicable collection point for the recycling of waste batteries.

For more detailed information about recycling of this product or battery, please contact your local Civic Office, your household waste disposal service or the shop where you purchased the product or battery.

For Customers in Singapore

Complies with
IDA Standards
DB00353

Table of contents

Introduction of functions	10
---------------------------------	----

Before use

Notes on using your camera	12
Checking the supplied items	15
Identifying parts	16
Front side	16
Rear side	17
Top side	19
Sides/Bottom	20
Lens	22
List of icons on the monitor	23
List of icons on the display panel	27

Functions list

Functions that can be operated using the buttons/dials	28
How to use the Quick Navi screen	29
Operating the camera	31
How to use the multi-selector	31
How to use the front dial/rear dial	31
Selecting a function using the Fn (Function) button	32
Functions that can be registered using the Fn (Function) button	33
Functions that can be selected using the MENU button	34
Using the In-Camera Guide	45

Preparing the camera

Charging the battery pack	46
Inserting the battery pack/memory card (sold separately)	48
Memory cards that can be used	50
Attaching a lens	51
Setting the date and time	53
Setting the date/time and area again	54
Shooting a clear image without camera shake	55
Camera shake warning indicator	55
Using the SteadyShot function	55
Using the SteadyShot function with the shutter button	56
Holding the camera properly	56
Removing the Eyepiece cup	57

Shooting and viewing images

Shooting still images	58
Recording movies	59
Playing back images	60
Switching between still images and movies	61
Deleting images	62

Selecting a shooting mode

Selecting a shooting mode	63
Functions available for each shooting mode	64

Various functions

Using the various functions	65
Autofocus functions	65
Creative Style	67
DRO/Auto HDR	68
Playback functions	69

Using Wi-Fi functions

Using the Wi-Fi and NFC one-touch functions	70
Connecting the camera to a wireless access point	71

Viewing images on a computer

Using the software	72
System requirements	72
Using Image Data Converter	73
Installing Image Data Converter	73
Using PlayMemories Home	74
Installing PlayMemories Home	75
Using Remote Camera Control	75
Installing Remote Camera Control	76

Others

Checking the number of images and recordable time of movies	77
Specifications	81

Index 88

For details on Wi-Fi functions, see the flyer “Wi-Fi Connection/One-touch (NFC) Guide.”

This manual covers several models supplied with different lenses.

The model name varies depending on the supplied lens. The available model varies depending on the countries/regions.

Model name	Lens
ILCA-77M2	Not supplied
ILCA-77M2Q	Supplied (DT 16 – 50 mm zoom lens)
ILCA-77M2M	Supplied (DT 18 – 135 mm zoom lens)

Introduction of functions

This section introduces some frequently used shooting functions and other unique functions.

See the pages in parentheses for details.

Shooting functions used frequently

Exposure Comp. (36)

You can adjust the exposure to change the brightness of the entire image. Even when the shooting mode is set to M, you can adjust the exposure if the ISO sensitivity is set to [ISO AUTO].

ISO/Multi Frame NR (36)

You can adjust the luminous sensitivity.

The ISO sensitivity can be adjusted between ISO 50 and ISO 25600.

When you select $\frac{\text{ISO}}{\text{AUTO}}$ (Multi Frame NR), you can select larger ISO numbers than the maximum ISO sensitivity.

White Balance (36)

You can adjust the color tones.

You can select an option to suit a light source, or perform fine adjustments using color temperature and color filters.

Drive Mode (35)

You can select an appropriate drive mode to suit your purposes, such as single shooting, continuous shooting, or bracket shooting.

Features of this camera

AF Range Control

You can restrict the autofocus range to prevent unintended subjects from being focused on.

DRO/Auto HDR (68)

[D-Range Opt.]: By dividing the image into small areas, the camera analyses the contrast of light and shadow between the subject and the background, and produces an image with the optimal brightness and gradation.

[Auto HDR]: Shoots 3 images with different exposures, and then overlays these images to create an image with rich gradation.

Creative Style (67)

You can select the desired style from among 13 styles.

You can also adjust certain image factors, such as exposure, using the selected style as the base.

Movie recording with manual adjustments (63)

You can adjust the exposure in P, A, S, or M mode even when shooting movies.

How to operate or customize the camera

Display information (38)

When you look into the viewfinder, the viewfinder mode is activated, and when you move your face away from the viewfinder, the viewing mode reverts to monitor mode (default settings). You can change the screen display mode by pressing the DISP button.

Quick Navi (29)

In [For viewfinder] screen, you can quickly switch from the monitor to the Quick Navi screen by pressing the Fn button. You can set the items with an intuitive operation.

Customization (41)

The camera is equipped with a Custom button, which you can assign a desired function to. You can also assign functions to other buttons, such as the AEL button.

Notes on using your camera

Screen language

You can select the language displayed on the screen using the menu (page 43).

Shooting procedure

This camera has 2 modes for monitoring subjects: the monitor mode using the monitor, and the viewfinder mode using the viewfinder.

Functions built into this camera

- This manual describes 1080 60i-compatible devices and 1080 50i-compatible devices.
To check whether your camera is a 1080 60i-compatible device or 1080 50i-compatible device, check for the following marks on the bottom of the camera.
1080 60i-compatible device: 60i
1080 50i-compatible device: 50i
- This camera is compatible with 1080 60p or 50p-format movies. Unlike standard recording modes up to now, which record in an interlacing method, this camera records using a progressive method. This increases the resolution, and provides a smoother, more realistic image.

Creating an image database file

If you insert a memory card that does not contain an image database file into the camera and turn on the power, the camera automatically creates an image database file using some of the memory card's capacity.

The process may take a long time and you cannot operate the camera until the process is completed. If a database file error occurs, export all images to your computer using PlayMemories Home™, and then format the memory card using the camera.

No compensation for damaged content or recording failure

Sony cannot compensate for failure to record or loss or damage of recorded content due to a malfunction of the camera or recording media, etc.

Back up recommendation

To avoid the data loss, always copy (back up) data to other media.

Notes on the monitor, electronic viewfinder, lens, and image sensor

- The monitor and electronic viewfinder are manufactured using extremely high-precision technology, and over 99.99% of the pixels are operational for effective use. However, there may be some small black dots and/or bright dots (white, red, blue or green in color) that constantly appear on the monitor and electronic viewfinder. These dots are normal due to the manufacturing process and do not affect the images in any way.
- Do not hold the camera by the monitor.
- Do not expose the camera to sunlight or shoot sunward for a long time. The internal mechanism may be damaged. If sunlight is focused on a nearby object, it may cause a fire.
- There is a magnet on the back and around the rotating shaft of the hinge part of the monitor. Do not bring anything that is easily affected by a magnet, such as floppy disks or credit cards, near the monitor.
- Images may trail across on the screen in a cold location. This is not a malfunction. When turning on the camera in a cold location, the screen may become temporarily dark. When the camera warms up, the screen will function normally.

- The recorded image may be different from the image you monitored before recording.

Notes on shooting with the viewfinder

This camera is equipped with an Organic Electro-Luminescence viewfinder with high resolution and high contrast. This viewfinder achieves a wide viewing angle and a long eye relief. This camera is designed to provide an easily viewable viewfinder by appropriately balancing various elements.

- The image may be slightly distorted near the corners of the viewfinder. This is not a malfunction. When you want to see the full composition with all its details, you can also use the monitor.
- If you pan the camera while looking into the viewfinder or move your eyes around, the image in the viewfinder may be distorted or the color of the image may change. This is a characteristic of the lens or display device and is not a malfunction. When you shoot an image, we recommend that you look at the center area of the viewfinder.
- When shooting with the viewfinder, you may experience symptoms such as eyestrain, fatigue, travel sickness, or nausea. We recommend that you take a break at regular intervals when you are shooting with the viewfinder. The required length or frequency of the break may differ depending on the individuals, so you are advised to decide at your own discretion. In case you may feel uncomfortable, refrain from using the viewfinder until your condition recovers, and consult your doctor as necessary.

Notes on recording for long periods of time

- Depending on the camera and battery temperature, you may be unable to record movies or the power may turn off automatically to protect the camera. A message will be displayed on the screen before the power turns off or you can no longer record movies. In this case, leave the power off and wait until the camera and battery temperature goes down. If you turn on the power without letting the camera and battery cool enough, the power may turn off again or you may be unable to record movies.
- Under high ambient temperatures, the temperature of the camera rises quickly.
- When the temperature of the camera rises, the image quality may deteriorate. It is recommended that you wait until the temperature of the camera drops before continuing to shoot.
- The surface of the camera may get warm. This is not a malfunction.

Notes on importing AVCHD movies to a computer

When importing AVCHD movies to a computer, download and use the software PlayMemories Home from the following website:

www.sony.net/pm/

Notes on the flash

- Do not carry the camera by the flash unit, or use excessive force on it.
- If water, dust or sand get into the open flash unit, it may cause a malfunction.
- Be sure to keep your fingers out of the way when you press the flash down.

Notes when playing movies on other devices

- This camera uses MPEG-4 AVC/H.264 High Profile for AVCHD format recording. Movies recorded in AVCHD format with this camera cannot be played with the following devices.
 - Other devices compatible with AVCHD format that do not support High Profile
 - Devices incompatible with the AVCHD format
 This camera also uses MPEG-4 AVC/H.264 Main Profile for MP4 format recording. For this reason, movies recorded in MP4 format with this camera cannot be played on devices other than those that support MPEG-4 AVC/H.264.
- Discs recorded with HD (high definition) image quality can be played back only on AVCHD format-compatible devices. DVD-based players or recorders cannot play back HD image quality discs, as they are incompatible with the AVCHD format. Also, DVD-based players or recorders may fail to eject HD image quality discs.
- Movies recorded in 1080 60p/1080 50p format can be played back only on 1080 60p/1080 50p-supported devices.

Warning on copyright

Television programs, films, videotapes, and other materials may be copyrighted. Unauthorized recording of such materials may be contrary to the provisions of the copyright laws.

The pictures used in this manual

The photographs used as examples of pictures in this manual are reproduced images, and are not actual images shot using this camera.

On the data specifications described in this manual

The data on performance and specifications are defined under the following conditions, except as described in this manual: at an ordinary ambient temperature of 25°C (77°F), and using a battery pack that has been fully charged until the CHARGE lamp has turned off.

How to turn off wireless network functions (Wi-Fi and NFC, etc.) temporarily

When you board an airplane, etc., you can turn off all wireless network functions temporarily.

Select MENU →  [Wireless] → [Airplane Mode] → [On].

If you set [Airplane Mode] to [On], an  (airplane) mark will be displayed on the screen.

Notes on wireless LAN

If your camera is lost or stolen, Sony bears no responsibility for the loss or damage caused by illegal access or use of the registered access point on the camera.

Checking the supplied items

First check the model name of your camera (page 9). The accessories supplied differ depending on the model.

The number in parentheses indicates the number of pieces.

Supplied with all models:

- Camera (1)
- BC-VM10A Battery charger (1)



- Power cord (mains lead) (1)* (not supplied in the U.S.A. and Canada)



* Multiple power cords may be supplied with your camera. Use the appropriate one that matches your country/region.

- Rechargeable battery pack NP-FM500H (1)



- Micro USB cable (1)

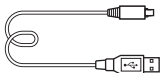

- Shoulder strap (1)

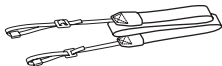

For how to attach the shoulder strap to the camera, refer to page 20.

- Body cap (1) (Attached on the camera)



- Shoe cap (1) (Attached on the camera)
- Eyepiece Cup (1) (Attached on the camera)
- Instruction Manual (1) (this manual)
- Wi-Fi Connection/One-touch (NFC) Guide (1)

This guide explains the functions that require a Wi-Fi connection.

ILCA-77M2Q:

- DT 16-50 mm zoom lens (1)/
Front lens cap (1)/Rear lens cap (1)/Lens hood (1)

ILCA-77M2M:

- DT 18-135 mm zoom lens (1)/
Front lens cap (1)/Rear lens cap (1)/Lens hood (1)

Identifying parts

See the pages in parentheses for details on operation for the parts.

Front side

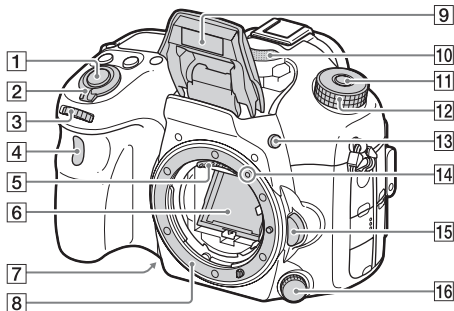

1 Shutter button (58)

2 Power switch (53)

3 Front control dial (31)

4 Remote sensor

5 Lens contacts*

6 Mirror*

7 Preview button (28)

8 Mount

9 Built-in flash*

- Press the ⚡ (Flash pop-up) button to use the flash.
- When not using the flash, press it back into the camera body.

10 Microphone**

11 Mode dial lock release button (58, 63)

12 Mode dial (63)

13 ⚡ (Flash pop-up) button (28)

14 Mounting index (51)

15 Lens release button (52)



16 Focus mode dial

* **Do not directly touch these parts.**



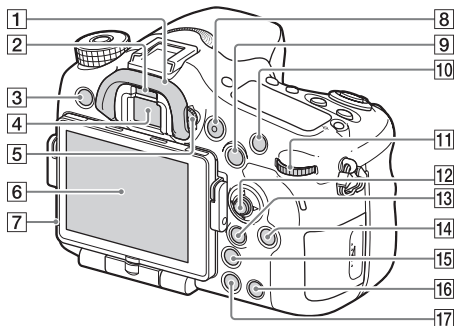

** **Do not cover this part during movie recording. Doing so may cause noise or lower the volume.**

Rear side

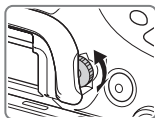





- | | |
|--|---|
| <p>1 Eyecup (57)</p> <p>2 Eye sensor</p> <p>3 MENU button (34)</p> <p>4 Viewfinder*</p> <ul style="list-style-type: none"> • When you look into the viewfinder, the viewfinder mode is activated, and when you take your face away from the viewfinder, the screen mode returns to the monitor mode. <p>5 Diopter-adjustment dial</p> <ul style="list-style-type: none"> • Adjust the diopter-adjustment dial according to your eyesight until the display appears clearly in the viewfinder. | <p>6 Monitor</p> <p>7 Light sensor</p> <p>8 MOVIE button (59)</p> <p>9 For shooting: AEL (AE lock) button (28)/SLOW SYNC button (28)
For viewing:  (Image index) button (69)</p> <p>10 For shooting: AF/MF (Auto focus/manual focus) button
For viewing:  (Enlarge) button</p> <p>11 Rear control dial (31)</p> <p>12 Multi-selector</p> |
|--|---|

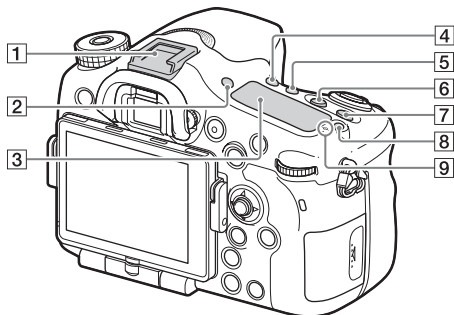

- 13** For shooting: Fn (Function) button (32)
For viewing:  (Send to Smartphone) button (28)
- You can display the screen for [Send to Smartphone] by pressing this button.
 - When you attach a vertical grip (sold separately), pressing the , (Image rotation) button on the vertical grip displays the [Send to Smartphone] screen.
- 14** DISP (Display) button (23)
- 15**  (Smart teleconverter) button (28)
- 16** C (Custom) button
For viewing:  (Delete) button (62)
- 17**  (Playback) button (60)
- * **Do not directly touch this part.**

Top side



- 1 Multi interface shoe*
- 2 FINDER/MONITOR button (28)
- 3 Display panel (27)
- 4  (Drive mode) button (28)
- 5 WB (White balance) button (28)
- 6  (Exposure) button (28)
- 7 ISO button (28)
- 8 Display panel illumination button (27)
- 9  Image sensor position mark

* For details on compatible accessories of the Multi interface shoe, visit the Sony website in your area, or consult your Sony dealer or local authorized Sony service facility.

Accessories for the Accessory Shoe can also be used.

Operations with other manufactures' accessories are not guaranteed.

ni Multi Interface Shoe

Accessory Shoe

Sides/Bottom

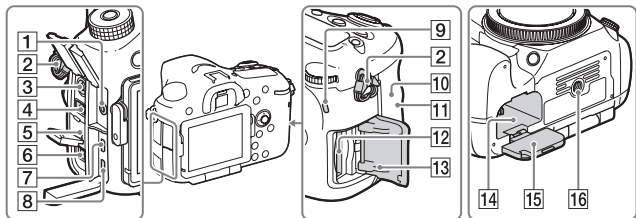

1 Microphone jack

- When an external microphone is connected, the internal microphone is turned off automatically. When the external microphone is a plug-in-power type, the power of the microphone is supplied by the camera.

2 Hooks for shoulder strap

- Attach both ends of the strap onto the camera.

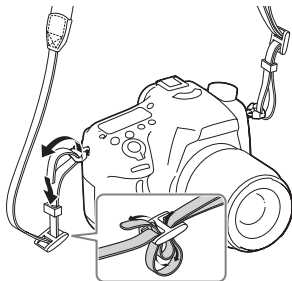

3 ⚡ (Flash sync) terminal



4 REMOTE terminal

- When connecting the RM-L1AM Remote Commander (sold separately) to the camera, insert the plug of the Remote Commander into the REMOTE terminal, aligning the guide of the plug with the guide of the REMOTE terminal. Make sure that the cord of the Remote Commander faces forward.

5 Speaker

6 DC IN terminal

- When connecting the AC-PW10AM AC Adaptor (sold separately) to the camera, turn the camera off, then plug the connector of the AC Adaptor to the DC IN terminal on the camera.

- 7 HDMI micro jack
- 8 Multi/Micro USB Terminal*
 - Supports Micro USB compatible device.
- 9 Access lamp
- 10  (N mark)
 - This mark indicates the touch point for connecting the camera and an NFC-enabled Smartphone.
For details on the location of the  (N mark) on your Smartphone, refer to the operating instructions of the Smartphone.
 - NFC (Near Field Communication) is an international standard of short-range wireless communication technology.
- 11 Wi-Fi sensor (built-in)
- 12 Memory card insertion slot (48)
- 13 Memory card cover (48)
- 14 Battery insertion slot (48)
- 15 Battery cover (48)
- 16 Tripod socket hole
 - Use a tripod with a screw less than 5.5 mm (7/32 inches) long. Otherwise, you cannot firmly secure the camera, and damage to the camera may occur.

* For details on compatible accessories for the Multi/Micro USB Terminal, visit the Sony website, or consult your Sony dealer or local authorized Sony service facility.

Lens

DT 16-50mm F2.8 SSM
(Supplied with the ILCA-77M2Q)

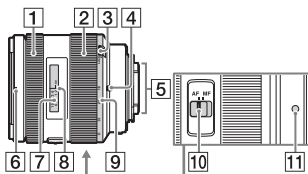

DT 18-135mm F3.5-5.6 SAM
(Supplied with the ILCA-77M2M)

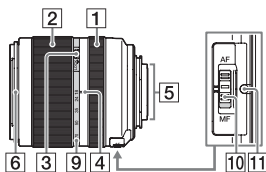

- 1 Focusing ring
- 2 Zoom ring
- 3 Zoom lock switch
- 4 Focal-length index
- 5 Lens contacts*
- 6 Lens hood index
- 7 Distance scale

- 8 Distance index
- 9 Focal-length scale
- 10 Focusing mode switch
- 11 Mounting index

* **Do not directly touch this part.**

- The DT 16-50mm F2.8 SSM/DT 18-135mm F3.5-5.6 SAM are designed for Sony A-mount cameras (models equipped with an APS-C sized image sensor). You cannot use these lenses on 35mm-format cameras.
- For the lenses other than DT 16-50mm F2.8 SSM/DT 18-135mm F3.5-5.6 SAM, refer to the operating instructions supplied with the lens.

List of icons on the monitor

The status of the monitor is set to [Display All Info.] in the default settings. When you change the [DISP Button] setting, and then press the DISP button, the screen status will change to the “For viewfinder” mode. You can also display the histogram by pressing the DISP button.

Monitor mode

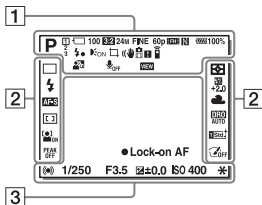

For playback (Basic information display)

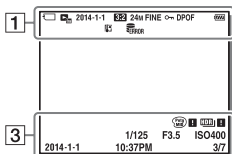

Before use

Viewfinder mode

In Auto Mode or Scene Selection mode

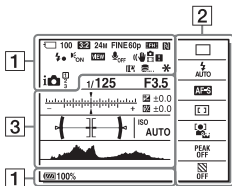

P/A/S/M/Sweep Panorama mode

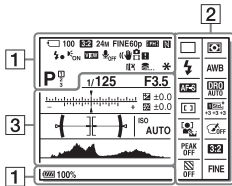





































1

Display	Indication
	Shooting mode (63)
	Register number (63)
	Scene Recognition icons
	Memory card (48)/ Upload (43)
100	Remaining number of recordable images
	Aspect ratio of still images (35)
	Image size of still images (77)
	Image quality of still images (35)
	Frame rate of movies
	Image size of movies (35)







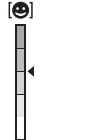







Display	Indication
	Remaining battery (49)
	Remaining battery warning
	Flash charge in progress
	Setting Effect OFF (39)
	AF Illuminator (36)
	NFC is activated
	Airplane Mode
	No audio recording of movies (38)
	Wind Noise Reduction (38)
	SteadyShot/Camera shake warning (37, 55)
	SteadyShot/Camera shake warning (37, 55)
	Overheating warning
	Database file full/ Database file error
	Smart Zoom/Clear Image Zoom/Digital Zoom
	Spot metering area
	Digital level gauge
	Audio level
	View Mode (42)
100-0003	Folder - file number
	Protect (42)
	Recording mode of movies
DPOF	DPOF set
	Auto Object Framing



2

Display	Indication
 Hi  S  C S  WB Lo	Drive mode (35)
 AUTO  SLOW REAR WL 	Flash mode (35)/Red-eye reduction (35)
 ±0.0	Flash compensation (35)
 AF-S AF-A AF-C MF DMF	Focus mode (28)
    	AF area
 OFF ON  ON  ON	Face Detection/Smile Shutter (37)
  	Metering mode (36)
 AWB       	White balance (Auto, Preset, Custom, Color temperature, Color filter) (36)
 D-R OFF DRO AUTO  HDR AUTO	D-Range Optimizer/Auto HDR (36)
 Std Vivid Nob  Char Dens Light  Peri Lans Sens  Night Auto B/W  Sate +3 +3 +3	Creative Style (36, 67)/ Contrast, Saturation, Sharpness

Display	Indication
 ON OFF	Center Lock-on AF (37)
 Pop Pst Fis Mtr Sm Fis Mtr Sm Fis Mtr Sm Fis Mtr Sm Fis Mtr Sm	Picture Effect (36)
	Smile detection sensitivity indicator

3

Display	Indication
	Center Lock-on AF guide
 -3 2 1 0 1 2 3+	EV scale
	Smart teleconverter (28)
	AF Range Control (65)
	Exposure compensation (36)/Metered Manual
 REC 0:12	Recording time of the movie (m:s)
	Focus
 1/250	Shutter speed
 F3.5	Aperture Value
 ISO400 ISO AUTO	ISO sensitivity (36)
	AE lock/FEL lock
	Shutter speed indicator
	Aperture indicator
	Histogram

Display	Indication
 	Auto HDR image warning
	Picture Effect error
2014-1-1 10:37PM	Date of recording
3/7	File number/Number of images in the view mode

List of icons on the display panel

You can adjust the shutter speed, aperture, exposure compensation, flash compensation, ISO sensitivity, white balance, drive mode and image quality by checking the display panel on the top of the camera.



Shutter speed (63)/ Aperture (63)		Exposure (36)/Flash compensation (35)	
ISO sensitivity (36)		White balance (36)	
Drive mode (35)/ Remote commander (43)		Image quality (35)	
Remaining battery (49)		Remaining number of recordable images* (77)	

* Even when the remaining number of recordable images is higher than 9,999, “9999” is displayed on the display panel.

To turn on the backlight of the display panel











Press the display panel illumination button on the top. Pressing again turns off the backlight.

Display panel illumination button



Functions that can be operated using the buttons/dials

You can set up or operate various functions using these buttons/dials. For the location of the buttons/dials, see “Identifying parts” (page 16).

 button	Pops the flash up.
 /  button	Selects the drive mode.
WB button	Adjusts the white balance.
 button	Compensates the exposure.
ISO button	Adjusts the ISO sensitivity.
FINDER/MONITOR button	Switches the display between the monitor and the viewfinder mode.
Display panel illumination button	Turns on the backlight of the display panel.
Mode dial	Switches the shooting mode.
MENU button	Displays the menu screen for setting menu items.
MOVIE button	Records movies.
AF/MF button /  button	Switches the autofocus and manual focus temporarily./ Scales an image up when viewing images.
AEL button / SLOW SYNC button /  button	Fixes the exposure of the entire screen./Shoots with the flash with a slower shutter speed./Displays multiple images on the screen simultaneously.
Fn button /  button	Displays the setup screen for functions set using the Fn button. In [For viewfinder] screen, switches to the Quick Navi screen./In playback mode, pressing  button switches to “Send to Smartphone” screen.
 button	Plays back images.
 button	Zooms in to the center of an image.
C button /  button	Assigns a frequently-used function to the button. [AF Range Control] is assigned to each button in the default settings./Deletes images.
Focus mode dial	Switches between the autofocus and manual focus mode.
Preview button	Checks the blurring of the background.

How to use the Quick Navi screen

Using the Quick Navi screen, you can change settings directly on the recording information display when the screen mode is set to [For viewfinder] (Quick Navi).

1 MENU button → **⚙ (Custom Settings) 2** → **[DISP Button]** → **[Monitor]** → **[For viewfinder]** → **[Enter]**

2 Press the DISP button to set the screen mode to [For viewfinder].

3 Press the Fn button to switch to the Quick Navi screen.

In Auto Mode or Scene Selection mode

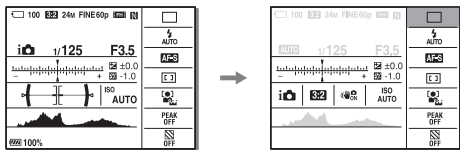

In P/A/S/M/Sweep Panorama mode

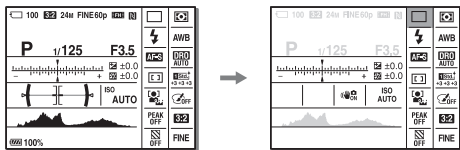





4 Select the desired item with ▲/▼/◀/▶ on the multi-selector.

5 Set the item with the front dial.

- Some setting values can be finely adjusted by turning the rear dial.
- Pressing the center of the multi-selector turns on the designated screen used to set up the selected item (page 31).
- Pressing the Fn button again turns off the Quick Navi screen and the screen goes back to the original one.

Functions available on the Quick Navi screen

Drive Mode	Flash Mode	Flash Comp.
Focus Area	Exposure Comp.	ISO
Metering Mode	White Balance	DRO/Auto HDR
Creative Style	Picture Effect	Smile/Face Detect.
Peaking Level	Zebra	 Image Size
 Aspect Ratio	 Quality	 SteadyShot
Auto Mode	Scene Selection	

Notes

- Gray items on the Quick Navi screen are not available.
- When using Creative Style (page 67), some of the setup tasks can be accomplished only on a designated screen.

Operating the camera

How to use the multi-selector

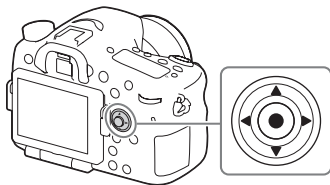

- You can use the up/down/left/right side of the multi-selector to move the selection frame. Press ● in the center of the multi-selector to set the selected item. In this manual, the up/down/left/right side of the multi-selector is indicated by ▲/▼/◀/▶.
- When you use ◀/▶ on the multi-selector in playback mode, you can display the previous or next image.
- [Standard] is assigned to ● in the center of the multi-selector in the default settings. When you press ●, the autofocus function is activated and the camera focuses on the subjects in the central area of the monitor.

How to use the front dial/rear dial

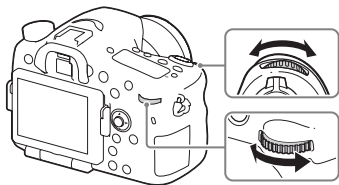

You can turn the front dial or rear dial to change the settings required for each shooting mode with immediate effect.

Selecting a function using the Fn (Function) button

This button is used for setting up or executing functions used frequently in shooting, except for functions from the Quick Navi screen.

1 Press the DISP button to set the screen mode to other than [For viewfinder].

2 Press the Fn button.

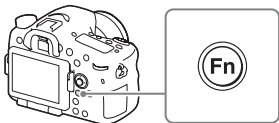

3 Select the desired item using ▲/▼/◀/▶ on the multi-selector.

The setting screen appears.

4 Select the desired setting by turning the front dial, then press ● on the multi-selector.

- Some setting values can be finely adjusted by turning the rear dial.

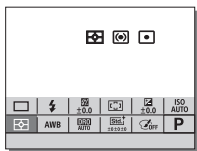

To set the individual settings in the dedicated screen

In step 3, select a setting item and press ● on the multi-selector to switch to the dedicated screen for the setting item. Set the items according to the Operation guide.









Operation guide

Functions that can be registered using the Fn (Function) button

You can select the functions to be displayed when you press the Fn (Function) button.

MENU button →  **(Custom Settings) 6** → **[Function Menu Set.]**
→ **Assign the function to the desired location.**

The functions that can be selected using the Fn button are as follows:

Drive Mode	Flash Mode	Flash Comp.
Focus Area	Exposure Comp.	ISO
Metering Mode	White Balance	DRO/Auto HDR
Creative Style	Shoot Mode	Picture Effect
Center Lock-on AF	Smile/Face Detect.	 Soft Skin Effect
 Auto Obj. Framing	 Image Size	 Aspect Ratio
 Quality	 SteadyShot	 SteadyShot
Audio Rec Level	Zebra	Grid Line
Audio Level Display	Peaking Level	Peaking Color
Not set		

Functions that can be selected using the MENU button

You can set up the basic settings for the camera as a whole, or execute functions such as shooting, playback, or other operations.

1 Press MENU button to display the menu screen.

2 Select the desired setting item using ▲/▼/◀/▶ on the multi-selector, and then press ● on the center of the multi-selector.

- Select an icon at the top of the screen and press the ◀/▶ on the multi-selector to move to another MENU item.

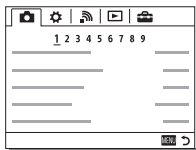





3 Select the setting value, then press ● to confirm.





To display the Tile Menu







Allows you to select whether to always display the first screen of the menu when you press the MENU button.

MENU →  (Setup) 2 → [Tile Menu] → [On]

 **(Camera Settings)**

 Image Size	Selects the size of still images. (L: 24M/M: 12M/S: 6.0M (3:2) L: 20M/M: 10M/S: 5.1M (16:9))
 Aspect Ratio	Selects the aspect ratio for still images. (3:2/16:9)
 Quality	Sets the image quality for still images. (RAW/RAW & JPEG/Extra fine/Fine/Standard)
Panorama: Size	Selects the size of panoramic images. (Standard/Wide)
Panorama: Direction	Sets the shooting direction for panoramic images. (Right/Left/Up/Down)
 File Format	Selects the movie file format. (AVCHD/MP4)
 Record Setting	Selects the quality and size of the recorded movie frame. (60i 24M(FX)/50i 24M(FX)/60i 17M(FH)/50i 17M(FH)/60p 28M(PS)/50p 28M(PS)/24p 24M(FX)/25p 24M(FX)/24p 17M(FH)/25p 17M(FH)/1440x1080 12M/VGA 3M)
Drive Mode	Sets the drive mode, such as for continuous shooting. (Single Shooting/Cont. Shooting/Self-timer/Self-timer(Cont)/Cont. Bracket/Single Bracket/WB bracket/DRO Bracket)
Flash Mode	Sets the flash settings. (Flash Off/Autoflash/Fill-flash/Slow Sync./Rear Sync./Wireless)
Flash Comp.	Adjusts the intensity of flash output. (+3.0EV to -3.0EV)
Flash control	Sets the method for determining the intensity of flash output. (ADI flash/Pre-flash TTL/Manual flash)
Power ratio	Sets the amount of built-in flash light when [Flash control] is set to [Manual flash]. (1/1–1/6)
Red Eye Reduction	Reduces the red-eye phenomenon when using flash. (On/Off)
AF-A setup	Sets whether fine adjustment of the manual focusing is possible when the focus mode is set to [AF-A]. (AF-A/DMF)



Focus Area	Selects the area of focus. (Wide/Zone/Center/Flexible Spot/Expand Flexible Spot/ Lock-on AF)
 AF Illuminator	Sets the AF illuminator, which provides light for a dark scene to aid focusing. (Auto/Off)
 AF drive speed	Switches the focusing speed for autofocus when shooting still images. If set to [Slow] in Macro shooting, it makes it easier to adjust the focus. (Fast/Slow)
 AF Track Duration	Sets the duration for AF tracking when shooting still images. (1 to 5)
 AF Track Duration	Sets the duration for AF tracking when shooting movies. (High/Mid/Low)
Exposure Comp.	Compensates for the brightness of the entire image. (-5.0EV to +5.0EV)
Exposure step	Selects the size of the increment step for shutter speed, aperture, and exposure. (0.5EV/0.3EV)
ISO	Sets the ISO sensitivity. (Multi Frame NR/ISO AUTO/ISO 50 to ISO 25600)
Metering Mode	Selects the method for measuring brightness. (Multi/Center/Spot)
White Balance	Adjusts the color tone of images. (Auto/Daylight/Shade/Cloudy/Incandescent/Fluor.: Warm White/Fluor.: Cool White/Fluor.: Day White/Fluor.: Daylight/Flash/C.Temp./Filter/Custom 1-3/Custom Setup)
DRO/Auto HDR	Compensates automatically for brightness and contrast. (Off/D-Range Opt./Auto HDR)
Creative Style	Selects the desired image processing. You can also adjust contrast, saturation, and sharpness. (Standard/Vivid/Neutral/Clear/Deep/Light/Portrait/ Landscape/Sunset/Night Scene/Autumn leaves/Black & White/Sepia/Style Box1-6)
Picture Effect	Shoots images with a texture unique to the selected effect. (Off/Toy Camera/Pop Color/Posterization/Retro Photo/Soft High-key/Partial Color/High Contrast Mono./Soft Focus/ HDR Painting/Rich-tone Mono./Miniature/Watercolor/ Illustration)



Zoom	Sets the zoom scale for the zoom function other than the optical zoom.
Focus Magnifier	Enlarges the image before shooting so that you can check the focus.
 Long Exposure NR	Sets noise reduction processing for shots with a shutter speed of 1 second or longer. (On/Off)
 High ISO NR	Sets noise reduction processing for high-sensitivity shooting. (Normal/Low/Off)
Center Lock-on AF	Sets the function to track a subject and continue focusing when pressing the center button in the shooting screen. (Off/On)
Smile/Face Detect.	Selects to detect faces and adjust various settings automatically. Sets to automatically release the shutter when a smile is detected. (Off/On (Regist. Faces)/On/Smile Shutter)
 Soft Skin Effect	Sets the Soft Skin Effect and the effect level. (On: High/On: Mid/On: Low/Off)
 Auto Obj. Framing	Analyzes the scene when capturing faces, close-ups, or subjects tracked by Lock-on AF function, and automatically trims and saves another copy of the image with a more impressive composition. (Off/Auto)
Auto Mode	You can shoot selecting either Intelligent Auto or Superior Auto. (Intelligent Auto/Superior Auto)
Scene Selection	Selects pre-set settings to match various scene conditions. (Portrait/Sports Action/Macro/Landscape/Sunset/Night Scene/Hand-held Twilight/Night Portrait)
Movie	Selects the exposure mode to suit your subject or effect. (Program Auto/Aperture Priority/Shutter Priority/Manual Exposure)
 SteadyShot	Sets SteadyShot for shooting still images. Reduces blur from camera shake when shooting while holding the camera. (On/Off)
 SteadyShot	Sets SteadyShot for shooting movies. Reduces blur from camera shake when shooting while holding the camera. (On/Off)
 Color Space	Changes the range of reproducible colors. (sRGB/AdobeRGB)















 Auto Slow Shut.	Sets the function that automatically adjusts the shutter speed following the brightness of the environment in movie mode. (On/Off)
Audio Recording	Sets whether to record audio when shooting a movie. (On/Off)
Audio Rec Level	Adjusts the audio recording level during movie recording. (0 to 31)
Audio Out Timing	Sets the timing of audio output during the movie recording. (Live/Lip Sync)
Wind Noise Reduct.	Reduces wind noise during movie recording. (On/Off)
Memory	Registers the desired modes or camera settings.

(Custom Settings)

Zebra	Displays stripes to adjust brightness. (Off/70 to 100/100+)
Focus Magnif. Time	Sets the length of time the image will be shown in an enlarged form. (2 Sec/5 Sec/No Limit)
Grid Line	Sets a grid line display to enable alignment to a structural outline. (Rule of 3rds Grid/Square Grid/Diag. + Square Grid/Off)
Audio Level Display	Sets Audio Level Display. (On/Off)
Auto Review	Sets auto review to display the captured image after shooting. (10 Sec/5 Sec/2 Sec/Off)
DISP Button	Sets the type of information to be displayed on the monitor or in the viewfinder by pressing the DISP button. (Graphic Display/Display All Info./No Disp. Info./Level/Histogram/For viewfinder*) * Displayed only on the monitor.
Peaking Level	Enhances the outline of in-focus ranges with a specific color when focusing manually. (High/Mid/Low/Off)
Peaking Color	Sets the color used for the peaking function. (Red/Yellow/White)

Exposure Set. Guide	Sets the guide displayed when exposure settings are changed in the shooting screen. (Off/On)
Live View Display	Sets whether to reflect settings such as exposure compensation in screen display. (Setting Effect ON/Setting Effect OFF)
 AF Rng. Ctrl Assist	Sets whether to display the assist area when using the [AF Range Control] function. The assist area helps you to know if the subject is located within the focus range you set. (On/Off)
AF Area Auto Clear	Sets whether the focus area should be displayed all the time or disappear shortly after the focus is achieved. (On/Off)
AF Area Points	Switches [AF Area Points] manually to prevent the points from being set to an unwanted value. (Auto/61 Points)
Flexible Spot Points	Sets whether to use all the [AF Area Points] or the central 15 points. (All/15 Points)
Wide AF Area Disp.	Sets whether the focus area is displayed when the focus area is set to [Wide]. (On/Off)
Zoom Setting	Sets whether to use the Clear Image Zoom and Digital Zoom when zooming. (Optical zoom only/On: Clear Image Zoom/On: Digital Zoom)
 Eye-Start AF	Sets whether to use auto focus when you look through the viewfinder. (On/Off)
FINDER/MONITOR	Sets the method for switching between the viewfinder and the monitor. (Auto/Manual)
Release w/o Lens	Sets whether shutter can open when the lens is not attached. (Enable/Disable)
Priority setup	Sets whether or not to release the shutter even when the focus is not confirmed in autofocus mode. (AF/Release/Balanced Emphasis)

 AF w/ shutter	Sets whether to perform AF when the shutter button is half pressed. This is useful when you want to adjust the focus and exposure separately. (On/Off)
 AEL w/ shutter	Sets whether to adjust the exposure by pressing the shutter button halfway down. This is convenient when you want to adjust the focus and exposure separately. (Auto/On/Off)
 SteadyS. w/ shut.	Sets whether to use the SteadyShot function by pressing the shutter button halfway down. (On/Off)
e-Front Curtain Shut.	Sets whether to use the electronic front curtain shutter function. (On/Off)
Superior Auto	Sets the shooting/recording procedure in [Superior Auto]. (Continuous Shooting (Auto/Off)/Image Extraction (Auto/Off))
Exp.comp.set	Sets whether to reflect exposure compensation value to flash compensation. (Ambient&flash/Ambient only)
Bracket order	Sets order of shooting for exposure bracket and white balance bracket. (0 → - → +/- → 0 → +)
Face Registration	Registers or changes the person to be given priority in the focus. (New Registration/Order Exchanging/Delete/Delete All)
AF Micro Adj.	Allows you to make fine adjustments to the position of the focus. (AF Adjustment Set./amount/Clear)
Lens Comp.	Compensates for distortion on the screen caused by the lens attached. (Shading Comp./Chro. Aber. Comp./Distortion Comp.)

Function Menu Set.	Customizes the functions displayed when the Fn (Function) button is pressed. (Drive Mode/ Flash Mode/ Flash Comp./Focus Area/ Exposure Comp./ISO/Metering Mode/White Balance/ DRO/ Auto HDR /Creative Style/Shoot Mode/Picture Effect/Center Lock-on AF/Smile/Face Detect./  Soft Skin Effect/  Auto Obj. Framing/  Image Size/  Aspect Ratio/  Quality/  SteadyShot/  SteadyShot/Audio Rec Level/Zebra/Grid Line/Audio Level Display/Peaking Level/ Peaking Color/Not set)
Custom Key Settings	Assigning functions to the various keys allows you to speed up operations by pressing the keys. (Focus Hold Button*/AEL Button/ISO Button/Exp. Comp. Button/WB Button/Drive Mode Button/AF/MF Button/C Button/Preview Button/  Button/Center Button) * You can assign a function to the focus hold button on the lens.
Dial Setup	Sets the functions of the front and rear control dials when the exposure mode is set to M. Dials can be used for adjusting shutter speed and aperture. ( SS  F/no./  F/no.  SS)
Dial Ev Comp	Compensates the exposure with the front or rear dial. (Off/  Front dial/  Rear dial)
MOVIE Button	Enables or disables for the MOVIE button.
Dial Lock	Sets whether to disable the front dial or rear dial by pressing and holding down the Fn button. (Lock/Unlock)

 (Wireless)

Send to Smartphone	Transfers images to display on a smartphone. (Select on This Device/Select on Smartphone)
Send to Computer	Backs up images by transferring them to a computer connected to a network.
View on TV	You can view images on a network-enabled TV.
Ctrl w/ Smartphone	Shoots still images and movies by controlling the camera remotely by a smartphone.
Airplane Mode	You can set this device to not perform wireless communications. (On/Off)

WPS Push	You can register the access point to the camera easily by pushing the WPS button.
Access Point Set.	You can register your access point manually.
Edit Device Name	You can change the device name under Wi-Fi Direct, etc.
Disp MAC Address	Displays the MAC address of the camera.
SSID/PW Reset	Resets the SSID and password of smartphone connection.
Reset Network Set.	Reset all network settings.

(Playback)

Delete	Deletes an image. (Multiple Img./All in this Folder/All with this date)
View Mode	Plays back images from a specified date or specified folder of still images and movies. (Date View/Folder View(Still)/Folder View(MP4)/AVCHD View)
Image Index	Displays multiple images at the same time. (9 Images /25 Images)
Display Rotation	Sets the playback direction of the recording image. (Auto/Manual/Off)
Slide Show	Shows a slide show. (Repeat/ Interval)
Rotate	Rotates the image.
 Enlarge Image	Enlarges the playback images.
4K Still Image PB	Outputs still images in 4K resolution to an HDMI connected TV that supports 4K.
Protect	Protects the images. (Multiple Img. /All in this Folder/All with this date/Cancel All in this Folder/Cancel All with this date)
Specify Printing	Adds a print order mark to a still image. (Multiple Img./Cancel All/Print Setting)

(Setup)

Monitor Brightness	Sets the screen brightness. (Auto/Manual/Sunny Weather)
Viewfinder Bright.	Sets the brightness of the viewfinder. (Auto/Manual)
Finder Color Temp.	Sets the color temperature of the viewfinder.

Volume Settings	Sets the volume for movie playback.
Audio signals	Sets whether to sound a beep during auto focus or self-timer operations. (On/Off)
Upload Settings	Sets the upload function of the camera when using an Eye-Fi card. (On/Off)
Tile Menu	Sets whether to display the tile menu every time you press the MENU button. (On/Off)
Mode Dial Guide	Turns the mode dial guide (the explanation of each shooting mode) on or off. (On/Off)
Delete confirm.	Sets which of Delete and Cancel is preselected in the Delete confirmation screen. ("Delete" first / "Cancel" first)
Pwr Save Start Time	Sets the time intervals to automatically switch to power save mode. (30 Min/5 Min/2 Min/1 Min/10 Sec)
PAL/NTSC Selector*	By changing the TV format of the device, shooting in a different movie format is possible.
Cleaning Mode	Starts the cleaning mode to clean the image sensor.
Demo Mode	Sets demonstration playback of a movie to on or off. (On/Off)
Remote Ctrl	Sets whether to use the infrared remote control. (On/Off)
HDMI Settings	Sets the HDMI connection settings. (HDMI Resolution/HDMI Info. Display/CTRL FOR HDMI)
USB Connection	Sets the USB connection method. (Auto/Mass Storage/MTP/PC Remote)
USB LUN Setting	Enhances compatibility by limiting the functions of USB connection. Set to [Multi] in normal conditions and to [Single] only when the connection between the camera and a computer or AV component cannot be established. (Multi/Single)
Language	Selects the language.
Date/Time Setup	Sets date and time, and daylight savings.
Area Setting	Sets the location of use.

Format	Formats the memory card.
File Number	Sets the method used to assign file numbers to still images and movies. (Series/Reset)
Select REC Folder	Changes the selected folder for storing images.
New Folder	Creates a new folder for storing still images and movies (MP4).
Folder Name	Sets the folder format for still images. (Standard Form/Date Form)
Recover Image DB	Recovers the image database file and enables recording and playback.
Display Media Info.	Displays the remaining recording time of movies and the recordable number of still images on the memory card.
Version	Displays the camera software version.
Setting Reset	Restores settings to their defaults. Select [Initialize] to restore all settings to their default values. (Initialize/ Camera Settings Reset)

* Only for 1080 50i compatible models.

If you switch this item, it will be required to format the memory card in the setting compatible with the PAL or NTSC system respectively. Also, note that it may not be possible to play back movies recorded with the NTSC system on a PAL system TV.

Using the In-Camera Guide

You can use [Custom Key Settings] to assign In-Camera Guide to the desired button.

The In-Camera Guide displays explanations for the currently selected menu function or setting.

1 Select MENU button → ⚙ (Custom Settings) 6 → [Custom Key Settings] → desired functions assigned to the button → [In-Camera Guide].

Press the MENU button and use the multi-selector to select a MENU item whose explanation you want to read, and then press the button to which [In-Camera Guide] is assigned.

Charging the battery pack

When using the camera for the first time, be sure to charge the NP-FM500H InfoLITHIUM™ battery pack (supplied).

The InfoLITHIUM battery pack can be charged even when it has not been fully depleted.

It can also be used when it has not been fully charged.

The charged battery pack is discharged little by little, even when you do not use it. To avoid missing an opportunity to shoot, charge the battery pack again before shooting.

1 Insert the battery pack into the battery charger.

Push the battery pack until it clicks.

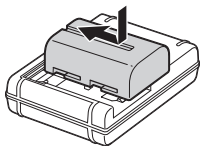

2 Connect the battery charger to the wall outlet (wall socket).

Light on: Charging

Light off: Charge completed

Charging time (Full charge)	Approx. 175 minutes
--------------------------------	---------------------

- When charging a fully depleted battery pack at a temperature of 25°C (77°F).
- The CHARGE lamp turns off when charging is completed.

For the U.S.A and Canada

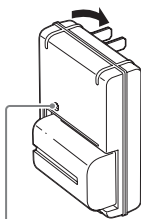

CHARGE lamp

For countries/regions other than the U.S.A. and Canada

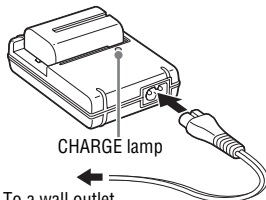

CHARGE lamp

To a wall outlet
(wall socket)

Notes

- The charging time differs depending on the remaining capacity of the battery pack or charging conditions.
- Be sure to use only genuine Sony brand battery packs.
- We recommend charging the battery pack in an ambient temperature of between 10°C to 30°C (50°F to 86°F). You may not be able to efficiently charge the battery pack outside this temperature range.
- Connect the battery charger to the nearest wall outlet (wall socket).

Inserting the battery pack/memory card (sold separately)

- 1** While sliding the battery cover open lever, open the cover.

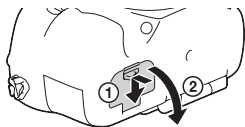

- 2** Firmly insert the battery pack all the way while pressing the lock lever with the tip of the battery.

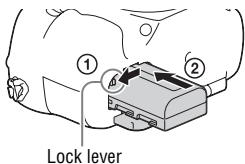

- 3** Close the cover.

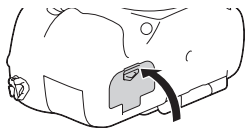

- 4** While sliding the memory card cover, open the cover.

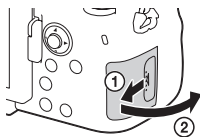

5 Insert a memory card.

- With the notched corner facing as illustrated, insert the memory card until it clicks into place.

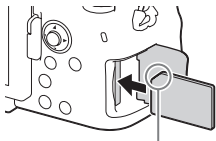

Ensure the notched corner faces correctly

6 Close the cover.

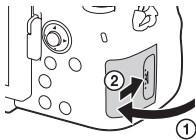

To remove the battery pack

Turn off the camera and slide the lock lever in the direction of the arrow. Be careful not to drop the battery pack.

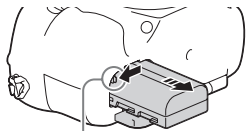

Lock lever

To remove the memory card

Check that the access lamp (page 21) is not lit, then open the cover, and push the memory card once.

To check the remaining battery level

The supplied battery pack is a lithium-ion battery pack that has functions for exchanging information related to operating conditions with your camera. The percentage of the remaining battery life is displayed according to the operating conditions of your camera.

Battery level						“Battery exhausted.”
	High Low					You cannot shoot any more pictures.

Memory cards that can be used

You can use the following types of memory cards with this camera. However, proper operation cannot be guaranteed for all types of memory cards.

	Memory card	For still images	For movies
A	Memory Stick PRO Duo™	✓	✓ (Mark2 only)
	Memory Stick PRO-HG Duo™	✓	✓
	Memory Stick XC-HG Duo™	✓	✓
B	SD memory card	✓	✓ (Class 4 or faster)
	SDHC memory card	✓	✓ (Class 4 or faster)
	SDXC memory card	✓	✓ (Class 4 or faster)

- In this manual, the products in the table are collectively referred to as follows:
 - A:** Memory Stick PRO Duo media
 - B:** SD card
- This camera supports UHS-I-compatible SD cards.

Notes

- Images recorded on a Memory Stick XC-HG Duo media or an SDXC memory card cannot be imported to or played on computers or AV devices that are not compatible with exFAT*. Make sure that the device is compatible with exFAT before connecting it to the camera. If you connect your camera to an incompatible device, you may be prompted to format the card.

Never format the card in response to this prompt, as doing so will erase all data on the card.

- * exFAT is the file system used on Memory Stick XC-HG Duo media and SDXC memory cards.

Attaching a lens

Set the power switch of the camera to OFF before you attach or remove the lens.

1 Remove the body cap from the camera and the rear lens cap from the rear of the lens.

- When changing the lens, quickly change the lens away from dusty locations to keep dust or debris from getting inside the camera.
- When shooting, remove the front lens cap from the front of the lens.

Front lens cap

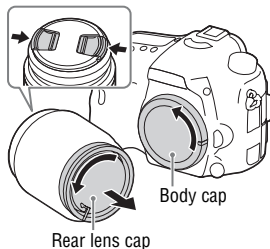

Rear lens cap

Body cap

2 Mount the lens by aligning the orange index marks (mounting indexes) on the lens and camera.

- Hold the camera with the lens facing down to prevent dust from entering into the camera.

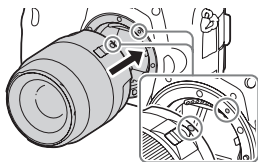

Orange index marks

3 While pushing the lens lightly toward the camera, turn the lens clockwise until it clicks into the locked position.

- Be sure to put the lens on straight.

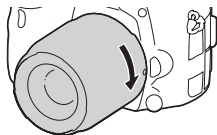

Notes

- When attaching a lens, do not press the lens release button.
- Do not use force when attaching a lens.
- E-mount lenses are not compatible with this camera.
- When you use a lens for which a tripod socket is provided, attach the lens onto the tripod using the tripod socket provided to help balance the weight of the lens.
- When carrying the camera with a lens attached, hold both the camera and the lens firmly.
- Do not hold the part of the lens that is extended for the zoom or focus adjustment.

To remove the lens

- 1 Press the lens release button all the way in and turn the lens counterclockwise until it stops.**

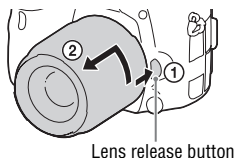

- 2 Attach the caps to the front and rear of the lens and the body cap to the camera.**

- Before you attach them, remove any dust from them.

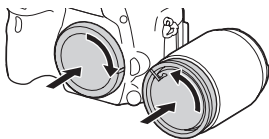

Notes on changing the lens

When changing the lens, if dust or debris gets inside the camera and adheres to the surface of the image sensor (the part that converts the light to an electric signal), it may appear as dark spots on the image, depending on the shooting environment.

The camera is equipped with an anti-dust function to prevent dust from landing on the image sensor. However, always make sure to quickly change the lens away from dusty locations when attaching/removing a lens.

Setting the date and time

When you turn on the camera for the first time or after you initialize the functions, the screen to set the date and time appears.

1 Set the power switch to ON to turn on the camera.

The screen to set the date and time appears.

- To turn the camera off, set the power switch to OFF.

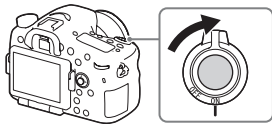

2 Check that [Enter] is selected on the screen, then press ● on the multi-selector.

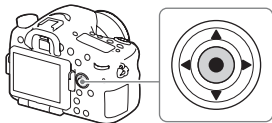

3 Select a desired geographic location, and then press ●.

4 Select a setting item by using ▲/▼ on the multi-selector, then press ●.

5 Select a desired setting by using ▲/▼/◀/▶ on the multi-selector, then press ●.

6 Repeat steps 4 and 5 to set other items, then select [Enter] and press ●.

To cancel the date and time setting operation

Press the MENU button.

Setting the date/time and area again

The date and time setup screen appears automatically when the power is turned on for the first time or when the internal rechargeable backup battery has been discharged. To reset the date and time, use the menu.

MENU button →  **(Setup) 4** →
[Date/Time Setup] or [Area Setting]
(page 43)

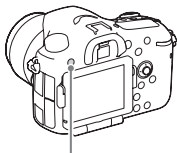

MENU button

Maintaining the date and time setting

This camera has an internal rechargeable battery for maintaining the date and time and other settings regardless of whether the power is on or off, or the battery is installed or not.

Shooting a clear image without camera shake

“Camera shake” refers to unwanted movement of the camera that occurs after the shutter button has been pressed, resulting in a blurred image. To reduce camera shake follow the instructions below.

Camera shake warning indicator

In situations where the camera may be subject to camera-shake, the  (Camera shake warning) indicator flashes. In this case, use a tripod or the flash.

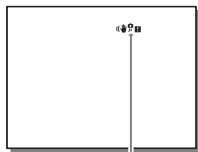

 (Camera shake warning) indicator

Notes

- The camera shake warning indicator does not appear in the following situations:
 - The exposure mode is set to M/S, or during movie recording.
 - When the viewing mode is set to [No Disp. Info.], [Level], or [Histogram].

Using the SteadyShot function

This camera is equipped with a camera shake compensation function to reduce camera shake. You can activate or deactivate the function for shooting still images and shooting movies separately. The default setting is [On] for shooting still images, and [Off] for shooting movies.



MENU button →  (Camera Settings) 8 →  SteadyShot]/
 SteadyShot] → Select the desired setting

Notes

- The SteadyShot function may not work optimally when the power has just been turned on, right after you point the camera towards a subject, or when the shutter button has been pressed all the way down without stopping halfway.
- When using a tripod, deactivate the SteadyShot function because there is a potential for malfunction of the SteadyShot function.



Using the SteadyShot function with the shutter button

Normally, the SteadyShot function for shooting still images was activated only for the shooting moment. With this camera, you can use the SteadyShot function while the shutter button is pressed halfway down ([ SteadyS. w/ shut.]).

[ SteadyS. w/ shut.] is set to [On] in the default settings. When you want to save the battery life, set [ SteadyS. w/ shut.] to [Off].

MENU button →  (Custom Settings) 5 → [ SteadyS. w/ shut.] → [On]

Notes

- You cannot use the [ SteadyS. w/ shut.] function when [ SteadyShot] is set to [Off].
- If you press the shutter button halfway down for a certain period of time, the SteadyShot function will be stopped temporarily to save the battery life, even when [ SteadyS. w/ shut.] is set to [On].

Holding the camera properly

Stabilize your upper body and take a position that keeps the camera from moving.

Viewfinder mode



Viewfinder mode
(vertical position)



Monitor mode



Point ①

One hand holds the grip of the camera, and the other hand supports the lens.

Point ②

Take a secure stance with your feet shoulder-width apart.

Point ③

Lightly tuck your elbows against your body.

When shooting in a kneeling position, steady your upper body by placing your elbow on your knee.

Removing the Eyepiece cup

When attaching the FDA-A1AM Angle Finder (sold separately) to the camera, remove the Eyepiece cup.

Remove the Eyepiece cup.

- Put your fingers under the Eyepiece cup, and slide it upward.

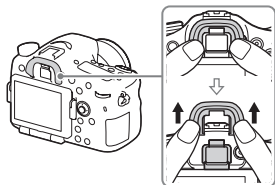

Notes

- When an FDA-A1AM Angle Finder (sold separately) is attached to the camera, switch the display between the viewfinder and the screen by pressing the FINDER/MONITOR button. Setting [Eye-Start AF] to [Off] is recommended because the eye sensor located above the viewfinder may otherwise be activated.

Shooting still images

In auto mode, the camera analyzes the subject and allows you to shoot with the appropriate settings.

1 Set the power switch to ON to turn on the camera.

2 Set the mode dial to **AUTO** (Auto Mode).

- Turn the mode dial while pressing the mode dial lock release button on the center of the mode dial.

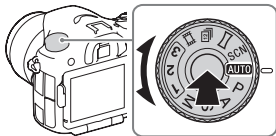

3 Look into the viewfinder and hold the camera.

When using a zoom lens, adjust the zoom ring to the proper size of the subject.

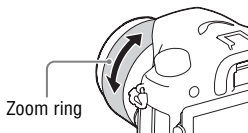

4 Press the shutter button halfway down to focus.

- When the image is in focus, a beep sounds and the ● or (●) indicator lights.

5 Press the shutter button fully down to shoot an image.

- If [Auto Obj. Framing] is set to [Auto], when shooting faces, close-up (macro) subjects, or subjects tracked by [Lock-on AF], the camera analyzes the scene and automatically trims the captured image into a suitable composition. Both the original and the trimmed images will be saved.

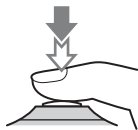

Recording movies

1 Set the mode dial to (Movie).

- When the [MOVIE Button] is set to [Always], the movie recording can be started from any shooting mode.
-

2 Press the MOVIE button to start recording.

MOVIE button



3 Press the MOVIE button again to stop recording.

Notes



- The sound of the camera in operation may be recorded while recording a movie. You can disable the sound recording by setting [Audio Recording] to [Off] (page 38).
- The continuous recording time of a movie depends on the ambient temperature or the condition of the camera. See “Notes on continuous movie recording” (page 80).
- When the  icon appears, the temperature of the camera is too high. Turn the camera off and wait until the temperature of the camera decreases.
- When you are recording continuously for a long time, you may feel that the camera is warm. This is normal. Also, “Internal temp. high. Allow it to cool.” may appear. In such cases, turn the camera off and wait until the camera is ready to shoot again.



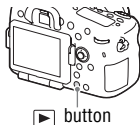









Playing back images

1 Press the  button.



2 Select an image by pressing the  on the multi-selector.

- To play back movies, press  on the multi-selector.
- If you press  on the multi-selector while playing back a movie, the control panel will be displayed.

Control panel	Action during movie playback
	Playback
	Pause
	Fast forward
	Fast rewind
	Forward slow playback
	Rewind slow playback
	Next movie
	Previous movie
	Frame advance
	Frame rewind
	Volume settings
	Closes the control panel

Notes

- Movies recorded using other devices may not play back on this camera.

Switching between still images and movies

To play back still images, set [View Mode] to [Folder View(Still)], and to play back movies, set [View Mode] to [Folder View(MP4)] or [AVCHD View]. When you select [Date View], both still images and movies will be displayed on the screen, sorted by date.

MENU button →  **(Playback) 1** → **[View Mode]** → **Select the desired mode.**

Deleting images

Once you have deleted an image, you cannot restore it. Be sure that you want to delete the image before proceeding.

1 While displaying the image you want to delete, press the  (Delete) button.



 (Delete) button

2 Select [Delete] with / on the multi-selector, then press .

- To delete several images at a time, select MENU button →  (Playback) 1 → [Delete].

Notes

- Protected images cannot be deleted.

Selecting a shooting mode

Turn the mode dial while pressing the mode dial lock release button on the center of the mode dial.

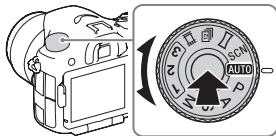

The following shooting modes are available.













AUTO (Auto Mode)	Allows you to shoot still images with the settings adjusted automatically.
P (Program Auto)	Allows you to shoot with the exposure (the shutter speed and the aperture value) adjusted automatically. The other settings can be adjusted manually.
A (Aperture Priority)	Shoots by adjusting the aperture and changing the focus range, or by defocus the background.
S (Shutter Priority)	Adjusts the shutter speed to show the movement of the subject.
M (Manual Exposure)	Allows you to shoot after manually adjusting the exposure (the shutter speed and the aperture value) using the front or rear dial.
1/2/3 (Memory recall)	Calls up settings pre-registered in [Memory] in the  (Camera Settings) (page 38).
[Movie] (Movie)	Allows you to change shooting settings and shoot a movie.
[12] (Cont. Priority AE)	Allows continuous shooting while the shutter button is fully depressed. The camera records the images continuously at a maximum of about 12 images per second.
[Sweep Panorama] (Sweep Panorama)	Allows you to shoot panoramic images by combining multiple images.
SCN (Scene Selection)	Allows you to shoot with preset settings according to the scene.

Functions available for each shooting mode

The functions you can use depend on the selected shooting mode.

In the table below, ✓ indicates the function is available, and a – indicates the function is not available.

The functions you cannot use are displayed in gray on the screen.

Shoot Mode (63)		Exposure Comp.	Self-timer	Cont. Shooting	Face Detection	Smile Shutter	Auto Obj. Framing
AUTO		–	✓	✓	✓	✓	✓
SCN		–	✓	–	✓	✓	✓
		–	–	✓	✓	✓	–
		–	✓	–	✓	✓	✓
		–	✓	–	–	–	✓
		–	✓	–	–	–	✓
		–	✓	–	–	–	✓
		–	–	–	✓	–	–
		–	✓	–	✓	✓	✓
	✓	–	–	–	–	–	
	✓	–	–	–	–	–	
P		✓	✓	✓	✓	✓	✓
A		✓	✓	✓	✓	✓	✓
S		✓	✓	✓	✓	✓	✓
M		–*	✓	✓	✓	✓	✓
		✓*	–	–	✓	–	–

* When the shooting mode is set to M, the exposure can be adjusted only when [ISO] is set to [ISO AUTO].

Using the various functions

This manual mainly provides an introduction on the use of the camera and a list of functions. To learn more about the camera, refer to “Help Guide” (page 2), which offers in-depth instructions on the many functions.

Autofocus functions

This camera achieves more accurate focusing with the autofocus functions by using a maximum of 79 focus points.

Set the focus mode dial to S (Single-shot AF), A (Automatic AF), or C (Continuous AF) to use the autofocus functions.



Focus mode dial

- S: The camera locks the focus when the focus adjustment is achieved.
- A: [Single-shot AF] and [Continuous AF] are switched according to the movement of the subject.
- C: The camera continues to focus while the shutter button is pressed and held halfway down.

While the camera uses a maximum of 79 focus points for the autofocus functions, the number of focus points will be limited when the following lenses are attached.



Lens	Number of focus points
SAL75300, SAL1118, SAL55200, SAL1855, SAL18552, SAL55200-2, SAL30M28, SAL55300	61 points
SAL500F80	One single point at the center

- This information is current as of the day the model was released. Some of the lenses above are not available in some countries or regions.

[Focus Area]: You can change the area of focus.

MENU button →  (Camera Settings) 3 → [Focus Area] → desired setting.

[ AF Track Duration]: You can change the duration for autofocus tracking. When you shoot fast-moving subjects, it is recommended to set to [5 (High)]. When you shoot subjects that intersects with other objects, it is recommended to set to [1 (Low)].

MENU button →  (Camera Settings) 4 → [ AF Track Duration] → desired setting.

[AF Range Control]: You can restrict the autofocus range to focus on a subject without interference from objects in the background and foreground.

The [AF Range Control] function is assigned to the C (Custom) button in the default settings.

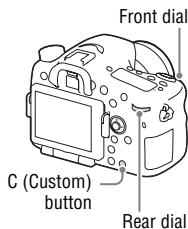

- ① Press the C (Custom) button.
- ② Set the maximum shooting distance with the front control dial and set the minimum shooting distance with the rear control dial, and then press the C button again.

- You can change the button to be assigned to the [AF Range Control] function by selecting the MENU button →  (Custom Settings) 6 → [Custom Key Settings] → desired item.
- Press the C (Custom) button again to quit the [AF Range Control] function.

Creative Style

You can select the desired kind of image processing from among 13 styles, and you can also adjust the contrast, saturation, and sharpness for each [Creative Style] item.

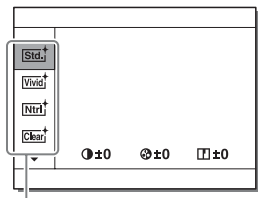
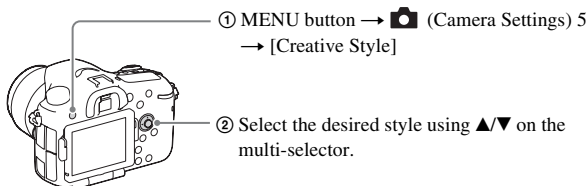

[Creative Style] item

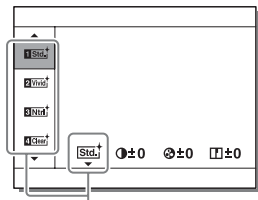

[Style Box]

You can fine-tune the setting and save the adjusted setting.

DRO/Auto HDR

Using the [DRO/Auto HDR] function, you can capture various gradations of the contrast of images.

[D-Range Opt.]: By dividing the image into small areas, the camera analyses the contrast of light and shadow between the subject and the background, and produces an image with the optimal brightness and gradation.



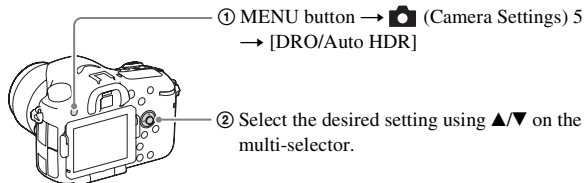

[Auto HDR]: Shoots 3 images with different exposures, and then overlays the correctly exposed image, the bright areas of an under exposed image and the dark areas of an over exposed image to create an image with rich gradation.

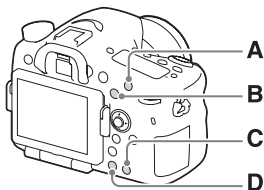

Playback functions

Convenient functions for playback are as follows:



- A**  Magnifies or reduces images.
- Turn the rear dial to magnify or reduce an image. Turn the front dial to switch to the next/previous image.
- B**  Image index screen
- You can select the number of images to be displayed: MENU →  (Playback) 1 → [Image Index]
- C**  Deletes unnecessary images.
- D**  Changes to the playback screen.



Using the Wi-Fi and NFC one-touch functions

You can perform the following operations using the camera's Wi-Fi and NFC One-touch functions.

Saving images to a computer.



Transferring images from the camera to a smartphone.



Using the smartphone as a remote control for the camera.

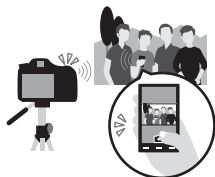

Viewing still images on a TV.



For details on the Wi-Fi and NFC One-touch functions, refer to the attached document “Wi-Fi Connection/One-touch (NFC) Guide” or to the “Help Guide” (page 2).

Connecting the camera to a wireless access point

Connect the camera to your wireless access point. Before starting the procedure, make sure you have the SSID (name of the access point) and password of your wireless access point with you.

1 MENU button →  (Wireless) 2 → [Access Point Set.].

2 Use ▲/▼ on the multi-selector to select the access point you want to connect to. Press ● in the center of the multi-selector and enter the password if a key icon is displayed with a wireless access point, then select [OK].

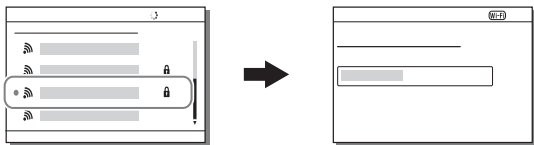

Notes

- If a connection is not established, see the wireless access point operating instructions or contact the administrator of the access point.
- To save images to a computer, install the following dedicated software on your computer.

When using Windows: PlayMemories Home

www.sony.net/pm/

When using Mac: Wireless Auto Import

<http://www.sony.co.jp/imsoft/Mac/>

Using the software

Use the following applications to optimize use of the images shot with your camera.

- Image Data Converter
- PlayMemories Home
- Remote Camera Control

For details on installation, see pages 73 to 76.

System requirements

You can find the system requirements for the software at the following URL:

www.sony.net/pcenv/



Using Image Data Converter

With Image Data Converter, you can do the following:

- You can play back and edit images recorded in RAW format with various corrections, such as tone curve and sharpness.
- You can adjust images with white balance, exposure, and [Creative Style], etc.
- You can save the images displayed and edited on a computer.
You can either save the image as RAW format or save it in a general file format.
- You can display and compare the RAW images and JPEG images recorded by this camera.
- You can rank images in 5 grades.
- You can apply color labels.

To use Image Data Converter, refer to Help.

Click [Start] → [All Programs] → [Image Data Converter] → [Help] → [Image Data Converter Ver.4].

Image Data Converter support page (English only)

<http://www.sony.co.jp/ids-se/>

Installing Image Data Converter

1 Download the software from the following URL and install it on your computer.

Windows:

<http://www.sony.co.jp/imsoft/Win/>

Mac:

<http://www.sony.co.jp/imsoft/Mac/>

Notes

- Log on as Administrator.

Using PlayMemories Home

The software PlayMemories Home allows you to import still images and movies to your computer and use them. PlayMemories Home is required for importing AVCHD movies to your computer.



Importing images from your camera



Playing back imported images



Sharing images on PlayMemories Online™



For Windows, the following functions are also available:



Viewing images on a calendar



Creating movie discs



Uploading images to network services

- You can download Image Data Converter or Remote Camera Control, etc. by performing the following procedure:
Connect the camera to your computer → launch PlayMemories Home → click [Notifications].

Notes

- An Internet connection is required to install PlayMemories Home.
- An Internet connection is required to use PlayMemories Online or other network services. PlayMemories Online or other network services may not be available in some countries or regions.
- Refer to the following URL for Mac software:
<http://www.sony.co.jp/imsoft/Mac/>
- If the software PMB (Picture Motion Browser), supplied with models released before 2011, has already been installed on your computer, it will be overwritten by PlayMemories Home during the installation. Use PlayMemories Home, the successor software of PMB.

- Movies recorded using the [60p 28M(PS)]/[50p 28M(PS)], [60i 24M(FX)]/[50i 24M(FX)] or [24p 24M(FX)]/[25p 24M(FX)] setting in [RECORD] Record Setting] are converted by PlayMemories Home to create an AVCHD recording disc. This conversion can take a long time. Also, you cannot create a disc with the original image quality. If you want to keep the original image quality, store your movies on a Blu-ray Disc.

Installing PlayMemories Home

- 1 Using the Internet browser on your computer, go to the following URL, then click [Install] → [Run].**

www.sony.net/pm/

- 2 Follow the instructions on the screen to complete the installation.**

Using Remote Camera Control

Connect the camera to your computer. With Remote Camera Control you can:

- Set up the camera or record an image from the computer.
- Record an image directly to the computer.
- Perform an Interval Timer Shooting.

Set up the following before use: MENU →  (Setup) 4 → [USB Connection] → [PC Remote]

Installing Remote Camera Control

1 Using the Internet browser on your computer, go to the following URL.

Windows:

<http://www.sony.co.jp/imsoft/Win/>

Mac:

<http://www.sony.co.jp/imsoft/Mac/>

2 Follow the instructions on the screen to download and install Remote Camera Control.

Notes

- An Internet connection is required to install Remote Camera Control.

Checking the number of images and recordable time of movies

When you insert a memory card into the camera and set the power switch to ON, the number of images that can be recorded (should you continue to shoot using the current settings) is displayed on the screen.

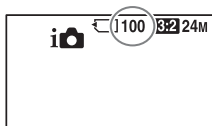

Notes

- When “0” (the number of recordable images) flashes in yellow, the memory card is full. Replace the memory card with another one, or delete images from the current memory card (pages 42, 62).
- When “NO CARD” (the number of recordable images) flashes in yellow, it means no memory card has been inserted. Insert a memory card.

The number of images that can be recorded on a memory card

The table below shows the approximate number of images that can be recorded on a memory card formatted with this camera. The values are defined using Sony standard memory cards for testing. The values may vary depending on the shooting conditions and the type of memory card used.

Image Size: L: 24M

Aspect Ratio: 3:2*

Memory card formatted with this camera (Units: Images)

Capacity \ Size	2 GB	4 GB	8 GB	16 GB	32 GB	64 GB
Standard	330	660	1350	2700	5400	10500
Fine	200	410	820	1650	3300	6600
Extra fine	100	200	400	820	1600	3250
RAW & JPEG	54	105	220	440	880	1750
RAW	74	145	300	600	1200	2400

* When [Aspect Ratio] is set to [16:9], you can record more images than the numbers shown in the table above (except when [RAW] is selected).

The number of images that can be recorded using a battery pack

Note that the actual numbers may differ depending on the conditions of use.

		Battery life	Number of images
Shooting (still images)	Screen	Approx. 240 min.	Approx. 480 images
	Viewfinder	Approx. 205 min.	Approx. 410 images
Actual shooting (movies)	Screen	Approx. 120 min.	—
	Viewfinder	Approx. 110 min.	—
Continuous shooting (movies)	Screen	Approx. 175 min.	—
	Viewfinder	Approx. 175 min.	—
Viewing (still images)	Screen	Approx. 270 min.	Approx. 5400 images
	Viewfinder	Approx. 320 min.	Approx. 6400 images

Notes

- The above number of images applies when the battery pack is fully charged. The number of images may decrease depending on the conditions of use.
- The number of images that can be recorded is for shooting under the following conditions:
 - The battery pack is used at an ambient temperature of 25°C (77°F).
 - Using the lens DT 16-50mm F2.8 SSM
 - Using Sony Memory Stick PRO Duo (Mark2) media (sold separately)
 - [Viewfinder Bright.] is set to [Manual] [±0].
 - [Monitor Brightness] is set to [Manual] [±0].
- The number for “Shooting (still images)” is based on the CIPA standard, and is for shooting under the following conditions: (CIPA: Camera & Imaging Products Association)
 - Focus mode: S (Single-shot AF)
 - Shooting once every 30 seconds.
 - The power turns on and off once every ten times.
- The number of minutes for movie shooting is based on the CIPA standard, and are for shooting under the following conditions:
 - [Record Setting] is set to [60i 17M(FH)]/[50i 17M(FH)].
 - Typical movie shooting: Battery life based on repeatedly shooting, zooming, shooting stand-by, turning on/off, etc.

- Continuous movie shooting: Battery life based on non-stop shooting until the limit (29 minutes) has been reached, and then continued by pressing the MOVIE button again. Other functions, such as zooming, are not operated.

Available recording time for a movie

The table below shows the approximate total recording times using a memory card formatted with this camera.

Memory card formatted with this camera (h (hour), m (minute))

Record Setting \ Capacity	2 GB	4 GB	8 GB	16 GB	32 GB	64 GB
60i 24M(FX)/50i 24M(FX)	10 m	20 m	40 m	1 h 30 m	3 h	6 h
60i 17M(FH)/50i 17M(FH)	10 m	30 m	1 h	2 h	4 h 5 m	8 h 15 m
60p 28M(PS)/50p 28M(PS)	9 m	15 m	35 m	1 h 15 m	2 h 30 m	5 h 5 m
24p 24M(FX)/25p 24M(FX)	10 m	20 m	40 m	1 h 30 m	3 h	6 h
24p 17M(FH)/25p 17M(FH)	10 m	30 m	1 h	2 h	4 h	8 h
1440×1080 12M	20 m	40 m	1 h 20 m	2 h 45 m	5 h 30 m	11 h
VGA 3M	1 h 10 m	2 h 25 m	4 h 55 m	10 h	20 h	40 h

- Continuous shooting is possible for approximately 29 minutes (a product specification limit). The maximum continuous recording time of an MP4 (12M) format movie is about 20 minutes (limited by the 2 GB file size restriction).

Notes

- The recordable time of movies varies because the camera is equipped with VBR (Variable Bit-Rate), which automatically adjusts image quality depending on the shooting scene. When you record a fast-moving subject, the image is clearer but the recordable time is shorter because more memory is required for recording. The recordable time also varies depending on the shooting conditions, the subject or the image quality/size settings.
- The values shown are not for continuous recording time.

- The recording time may differ depending on shooting conditions and the memory card used.
- When [🔥] is indicated, stop recording the movie. The temperature inside the camera has increased to an unacceptable level.
- For details on movie playback, see page 60.

Notes on continuous movie recording

- It requires a lot of power to perform high quality movie recording or continuous shooting using the image sensor. Therefore, if you continue to shoot, the temperature inside the camera will rise, especially that of the image sensor. In such cases, the camera turns off automatically since higher temperatures affect the quality of the images or affect the internal mechanism of the camera.
- The duration of time available for movie recording is as follows when the camera starts recording after the power of the camera has been turned off for a while. (The following values indicate the continuous time from when the camera starts recording until the camera stops recording.)

Ambient temperature	Continuous recording time for movies
20°C (68°F)	About 29 minutes
30°C (86°F)	About 29 minutes
40°C (104°F)	About 17 minutes

- The duration of time available for movie recording varies with the temperature or condition of the camera before you start recording. If you frequently recompose or shoot images after the power is turned on, the temperature inside the camera will rise and the recording time available will be shorter.
- If the camera stops recording due to the temperature, leave it for several minutes with the power turned off. Start recording after the temperature inside the camera drops fully.
- If you observe the following points, the recording time will be longer.
 - Keep the camera out of direct sunlight.
 - Turn the camera off when it is not being used.
- The maximum size of a movie file is about 2 GB. When the file size is about 2 GB, recording stops automatically when [📁 File Format] is set to [MP4], and a new movie file is created automatically when [📁 File Format] is set to [AVCHD].
- The maximum continuous recording time is 29 minutes.

Specifications

Camera

[System]

Camera Type: Built-In-Flash
Interchangeable Lens Digital
Camera

Lens: Sony A-mount lens

[Image sensor]

Image format: 23.5 mm×15.6 mm
(APS-C format) CMOS image
sensor

Total pixel number of image sensor:
Approx. 24 700 000 pixels

Effective pixel number of camera:
Approx. 24 300 000 pixels

[SteadyShot]

For still images:
System: Image sensor-shift
mechanism

For movies:
System: Electronic

[Anti-Dust]

System: Charge protection coating on
image sensor and image sensor
shift mechanism

[Auto focus system]

System: TTL phase-detection system
(with center F2.8 sensor),
79 points (15 points cross type)
Sensitivity Range: -2 EV to 18 EV
(at ISO 100 equivalent)
AF illuminator: Approx. 1 m to 5 m
(3.3 ft. to 16.4 ft.)

[Electronic viewfinder]

Type: Electronic viewfinder (Organic
Electro-Luminescence)
Screen size: 1.3 cm (0.5 type)
Total number of dots: 2 359 296 dots
Frame coverage: 100%
Magnification:
Approx. 1.09 ×
Approx. 0.71 × (35mm-format
equivalent) with 50 mm lens at
infinity, -1 m⁻¹
Eye Point: Approximately 27 mm
from the eyepiece, 22 mm from
the eyepiece frame at -1 m⁻¹
(CIPA standard compliant)
Diopter Adjustment: -4.0 m⁻¹ to
+3.0 m⁻¹

[LCD monitor]

LCD panel: 7.5 cm (3.0 type) TFT
drive
Total number of dots: 1 228 800
(640 × 4 (RGBW) × 480) dots

[Exposure control]

Metering Cell: "Exmor" CMOS sensor
 Metering method: 1 200-zone evaluative metering
 Metering Range: -2 EV to +17 EV on Multi segment, Center weighted, Spot modes (at ISO 100 equivalent with F1.4 lens)
 ISO sensitivity (Recommended exposure index):
 Still images: AUTO, ISO 50 to 25 600 (1/3 EV step)
 Movies: AUTO, ISO 100 to 12 800 (1/3 EV step)
 Exposure compensation: ± 5.0 EV (switchable between 1/3 EV and 1/2 EV steps)

[Shutter]

Type: Electronically-controlled, vertical-traverse, focal-plane type
 Speed range:
 Still images: 1/8 000 second to 30 seconds, bulb
 Movies: 1/8 000 second to 1/4 second (1/3 step), up to 1/60 second in AUTO mode (up to 1/30 second in Auto slow shutter mode)
 Flash sync speed: 1/250 second

[Built-In-Flash]



Flash G.No.: GN 12 (in meters at ISO 100)
 Recycling time: Approx. 3 seconds
 Flash coverage: Covering 16 mm lens (focal length that the lens indicates)
 Flash compensation: ± 3.0 EV (switchable between 1/3 EV and 1/2 EV steps)
 Flash range:

Aperture		F2.8	F4.0	F5.6
ISO setting	100	1 m – 4.3 m (3.3 ft. – 14.1 ft.)	1 m – 3 m (3.3 ft. – 9.8 ft.)	1 m – 2.1 m (3.3 ft. – 7.0 ft.)
	200	1 m – 6.1 m (3.3 ft. – 19.9 ft.)	1 m – 4.2 m (3.3 ft. – 13.9 ft.)	1 m – 3 m (3.3 ft. – 9.9 ft.)
	400	1.4 m – 8.6 m (4.7 ft. – 28.1 ft.)	1 m – 6 m (3.3 ft. – 19.7 ft.)	1 m – 4.3 m (3.3 ft. – 14.1 ft.)
	800	2 m – 12 m (6.6 ft. – 39.8 ft.)	1.4 m – 8.5 m (4.6 ft. – 27.8 ft.)	1 m – 6.1 m (3.3 ft. – 19.9 ft.)

[Continuous shooting]

Continuous shooting speed:

Continuous Advance Priority AE:
Maximum 12 images per second/

 Hi : Maximum 8 images per second/
 Lo : Maximum 3 images per second

- Based on our measurement conditions. The speed of continuous shooting can be slower, depending on the shooting conditions.

The maximum number of continuous shots:

In Continuous Advance Priority AE mode

Extra fine: 53 images/

Fine: 60 images/

Standard: 64 images/

RAW & JPEG: 25 images/

RAW: 26 images/

In Continuous shooting

Extra fine: 56 images/

Fine: 75 images/

Standard: 93 images/

RAW & JPEG: 26 images/

RAW: 28 images

[Image zooming playback]

Scaling range:

Image size:

L: Approx. $\times 1.0 - \times 18.8$ /

M: Approx. $\times 1.0 - \times 13.3$ /

S: Approx. $\times 1.0 - \times 9.4$

[Recording format]

File format: JPEG (DCF Ver. 2.0, Exif Ver. 2.3, MPF Baseline) compliant, RAW (Sony ARW 2.3 format)

Movie (AVCHD format): AVCHD format Ver. 2.0 compatible

Video: MPEG-4 AVC/H.264

Audio: Dolby Digital 2ch, equipped with Dolby Digital Stereo Creator

- Manufactured under license from Dolby Laboratories.

Movie (MP4 format):

Video: MPEG-4 AVC/H.264

Audio: MPEG-4 AAC-LC 2ch

[Recording media]

Memory Stick PRO Duo media, SD card

[Input/output terminals]

Multi/Micro USB Terminal*:

USB communication, Hi-Speed USB (USB 2.0)

* Supports Micro USB compatible devices.

HDMI: HDMI type D micro jack

Mic Terminal: \varnothing 3.5 mm Stereo mini jack

REMOTE Terminal

[Power, general]

Battery pack: Rechargeable battery pack NP-FM500H

[Power consumption]

When using a DT 16-50 mm F2.8
SSM*

When using the viewfinder:

Approx. 3.5 W

When using the screen:

Approx. 3.0 W

* Supplied with ILCA-77M2Q.

[Others]

Microphone: Stereo

Speaker: Monaural

Exif Print: Compatible

DPOF: Compatible

PRINT Image Matching III:

Compatible

Dimensions:

142.6 mm × 104.2 mm ×

80.9 mm (5 5/8 inches ×

4 1/8 inches × 3 1/4 inches)

(W/H/D, excluding protrusions)

Mass:

Approx. 726 g (1 lb 9.6 oz) (with
battery and Memory Stick PRO
Duo media)

Approx. 647 g (1 lb 6.8 oz) (body
only)

Operating temperature: 0°C to 40°C
(32°F to 104°F)

[Wireless LAN]

Supported format: IEEE 802.11 b/g/n

Frequency band: 2.4 GHz bandwidth

Security: WEP/WPA-PSK/WPA2-
PSK

Connection method: WPS (Wi-Fi
Protected Setup)/Manual

Access method: Infrastructure mode

NFC: NFC Forum Type 3 Tag
compliant

Design and specifications are
subject to change without notice.

Battery charger/Battery**BC-VM10A Battery charger**

Input rating: 100 V - 240 V AC,
50/60 Hz, 9 W

Output rating: 8.4 V DC, 0.75 A

Operating temperature range:

0°C to 40°C (32°F to 104°F)

Storage temperature range:

-20°C to +60°C (-4°F to +140°F)

Maximum dimensions:

Approx. 70 mm × 25 mm ×

95 mm (2 7/8 inches × 1 inch ×

3 3/4 inches) (W/H/D)

Rechargeable battery pack**NP-FM500H**

Battery type: Lithium-ion battery

Maximum voltage: DC 8.4 V

Nominal voltage: DC 7.2 V

Maximum charge voltage: DC 8.4 V

Maximum charge current: 2.0 A

Capacity:

Typical: 11.8 Wh (1 650 mAh)

Minimum: 11.5 Wh (1 600 mAh)

Maximum dimensions:

Approx. 38.2 mm × 20.5 mm ×

55.6 mm (1 9/16 inches ×

13/16 inches × 2 1/4 inches)

(W/H/D)

Lens

Name (Model name)	DT 16-50mm F2.8 SSM (SAL1650)	DT 18-135mm F3.5-5.6 SAM (SAL18135)
Equivalent 35mm-format focal length* (mm)	24–75	27–202.5
Lens groups/elements	13–16	11–14
Angle of view*	83°–32°	76°–12°
Minimum focus** (m (ft.))	0.3 (1)	0.45 (1.48)
Maximum magnification (×)	0.2	0.25
Minimum aperture	f/22	f/22–f/36
Filter diameter (mm)	72	62
Dimensions (max. diameter × height) (Approx. mm (in.))	81×88 (3 1/4 × 3 1/2)	76×86 (3 × 3 1/2)
Mass (Approx. g (oz.))	577 (20 3/8)	398 (14)

* The values for equivalent 35mm-format focal length and angle of view are based on Interchangeable Lens Digital Camera equipped with an APS-C sized image sensor.

** Minimum focus is the shortest distance from the image sensor to the subject.

- This lens is equipped with a distance encoder. The distance encoder allows more accurate measurement (ADI) by using a flash with ADI functionality.
- Depending on the lens mechanism, the focal length may change with any change of the shooting distance. The focal length assumes the lens is focused at infinity.
- The infinity position provides for some adjustment to compensate for focus shift caused by change in temperature. To shoot a subject at infinite distance in MF mode, use the viewfinder and set focus.

On focal length

The picture angle of this camera is narrower than that of a 35 mm-format camera. You can find the approximate equivalent of the focal length of a 35 mm-format camera, and shoot with the same picture angle, by increasing the focal length of your lens by half.

For example, by using a 50 mm lens, you can get the approximate equivalent of a 75 mm lens of a 35 mm-format camera.

On image data compatibility

- This camera conforms with DCF (Design rule for Camera File system) universal standard established by JEITA (Japan Electronics and Information Technology Industries Association).
- Playback of images recorded with your camera on other equipment and playback of images recorded or edited with other equipment on your camera are not guaranteed.

Trademarks

- Memory Stick and  are trademarks or registered trademarks of Sony Corporation.
- “AVCHD Progressive” and the “AVCHD Progressive” logotype are trademarks of Panasonic Corporation and Sony Corporation.
- Dolby and the double-D symbol are trademarks of Dolby Laboratories.
- The terms HDMI and HDMI High-Definition Multimedia Interface, and the HDMI Logo are trademarks or registered trademarks of HDMI Licensing LLC in the United States and other countries.
- Windows is a registered trademark of Microsoft Corporation in the United States and/or other countries.
- Mac is a registered trademark of Apple Inc. in the United States and other countries.
- iOS is a registered trademark or trademark of Cisco Systems, Inc.
- iPhone and iPad are registered trademarks of Apple Inc. in the United States and other countries.
- SDXC logo is a trademark of SD-3C, LLC.
- Android, Google Play are trademarks of Google Inc.
- Wi-Fi, the Wi-Fi logo and Wi-Fi PROTECTED SET-UP are registered trademarks of the Wi-Fi Alliance.
- The N Mark is a trademark or registered trademark of NFC Forum, Inc. in the United States and in other countries.

- DLNA and DLNA CERTIFIED are trademarks of Digital Living Network Alliance.
- Facebook and the “f” logo are trademarks or registered trademarks of Facebook, Inc.
- YouTube and the YouTube logo are trademarks or registered trademarks of Google Inc.
- Eye-Fi is a trademark of Eye-Fi, Inc.
- In addition, system and product names used in this manual are, in general, trademarks or registered trademarks of their respective developers or manufacturers. However, the TM or ® marks may not be used in all cases in this manual.



Index

A

- Area Setting53
- AUTO58
- Auto Mode58

B

- Battery pack46, 48

C

- CHARGE lamp47
- Charging battery pack46
- Computer72
- Creative Style67

D

- Date/Time Setup53
- DC IN terminal20
- Delete62
- Diopter-adjustment17
- DISP38
- Display panel27
- Display panel illumination button
.....27
- Drive Mode35
- DRO/Auto HDR68

E

- Eye sensor17

F

- File Format 35
- Fn 32, 33
- Focal length 85
- Function button 32, 33

H

- Help Guide 2

I

- Image Data Converter 73
- In-Camera Guide 45

L

- Language 12

M

- Memory card 48, 50
- MENU 34
- Monitor 23
- MOVIE 59
- MOVIE Button 59
- MR 63
- Multi interface shoe 19
- Multi-selector 31

N

- NFC 70
- Number of recordable images 77

P

PlayMemories Home 74, 75

Q

Quick Navi 29

R

Recordable time of movies 79

Recording movies 59

Reducing camera shake 55

Remote Camera Control 75

Remote Commander 20

S

Scene Selection 37

Set the clock 53

Shooting 58

Shooting mode 63

Shooting still images 58

Shoulder strap 20

Software 72

Specifications 81

SteadyShot 55

Still/Movie Select 61

V

Viewfinder 17

Viewing image 60

W

White Balance 36

Wi-Fi 9, 70



<http://www.sony.net/SonyInfo/Support/>

Additional information on this product and answers to frequently asked questions can be found at our Customer Support Website.

<http://www.sony.net/>



4536323110

©2014 Sony Corporation Printed in Thailand