

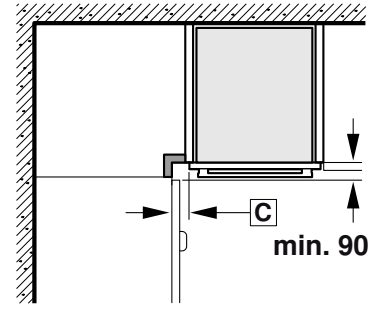

en Installation instructions

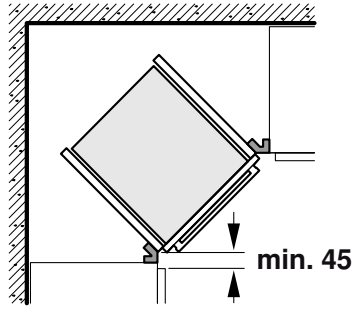

1

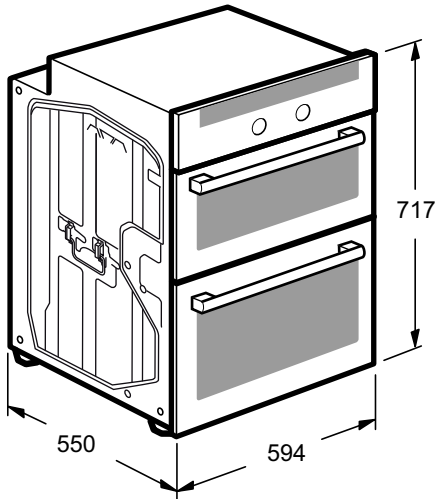

2

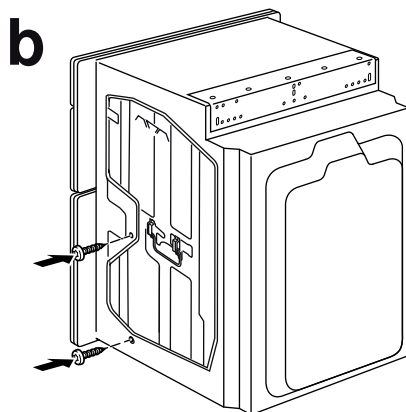
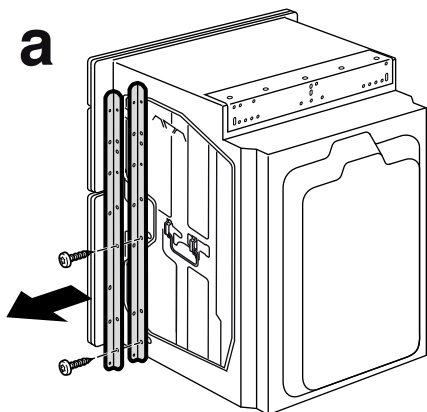
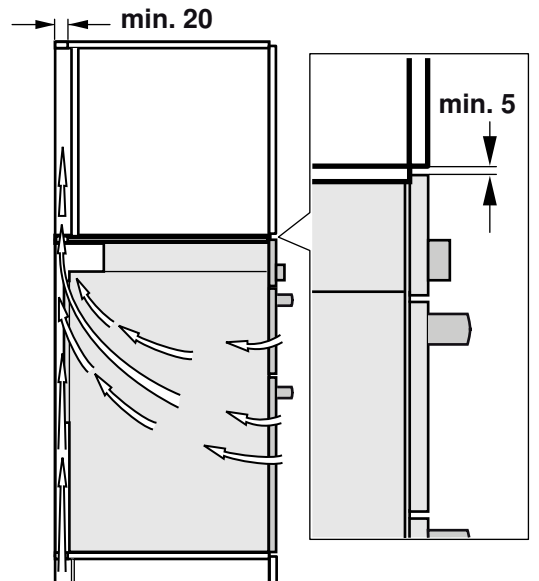
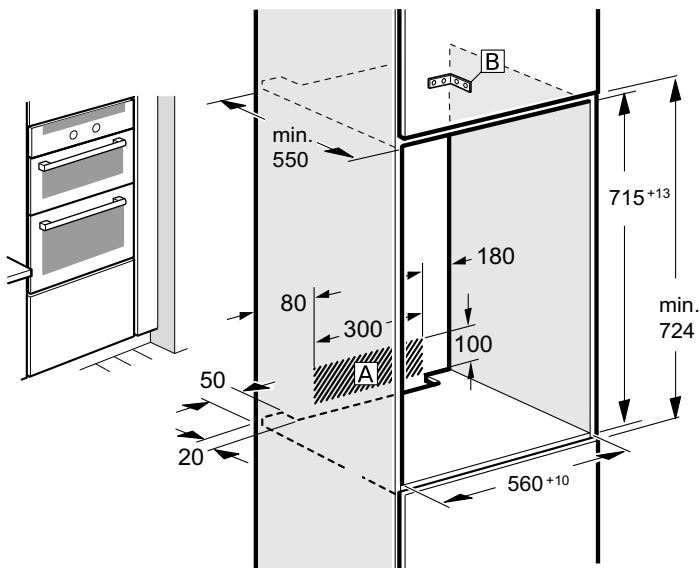

**3**

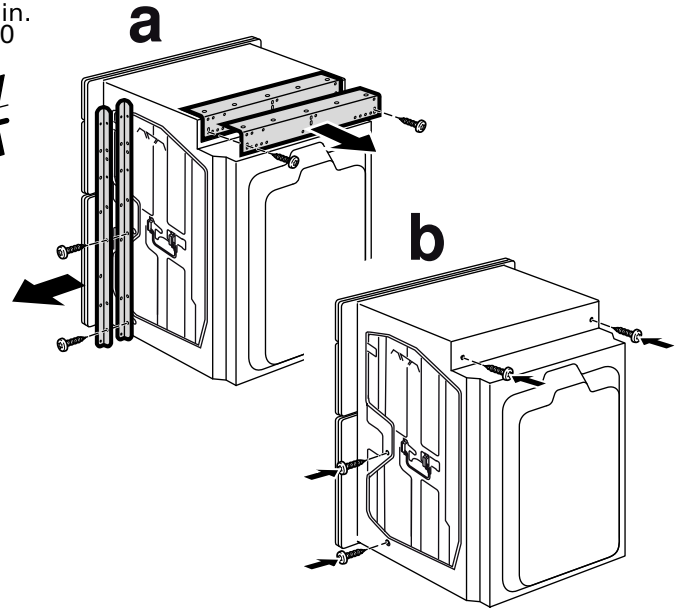
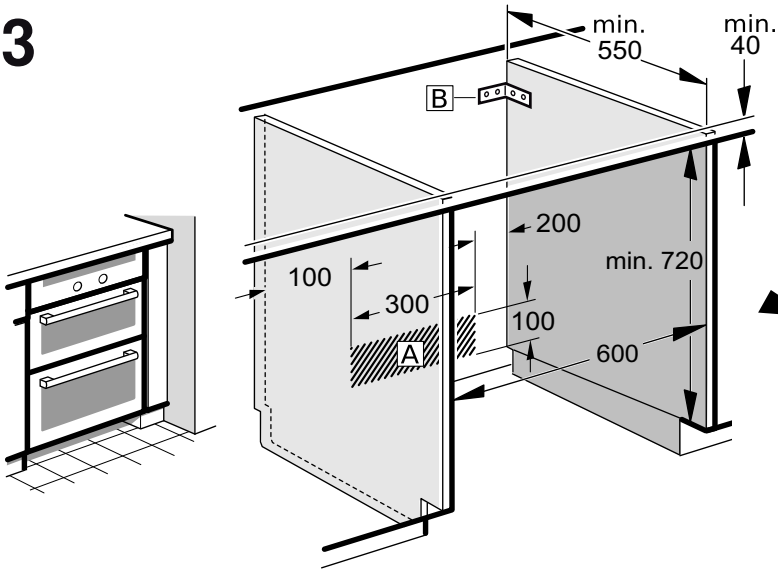

**c**

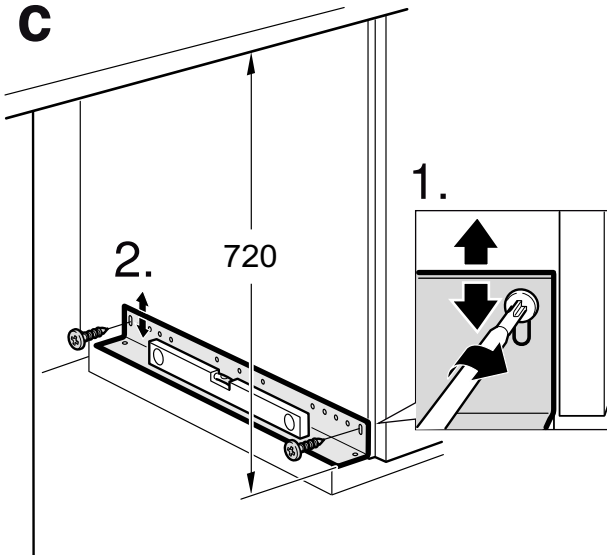

**d**

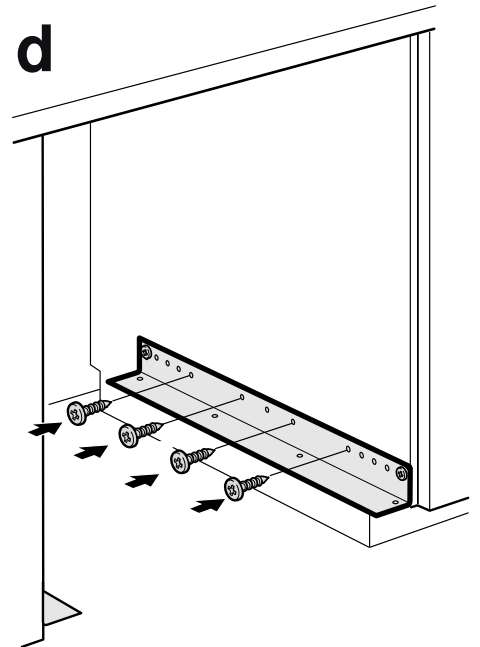

**e**

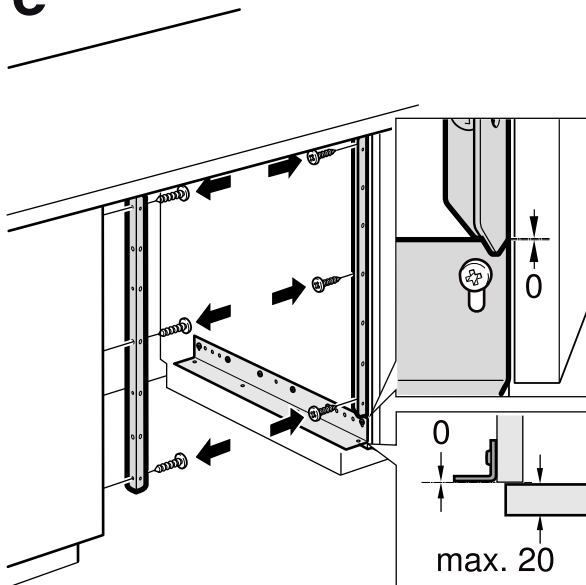

**f**

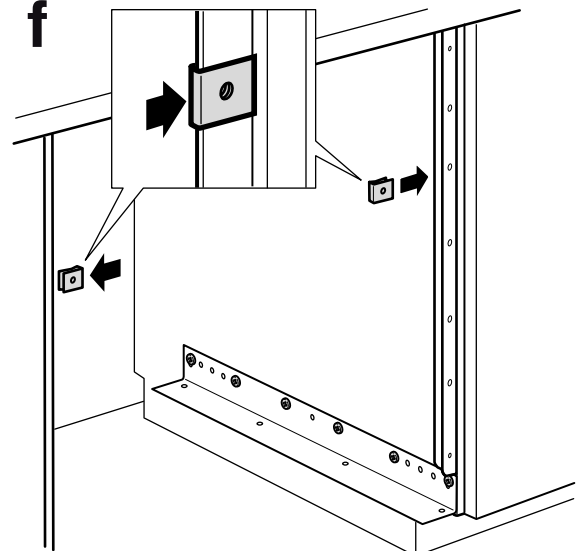

4

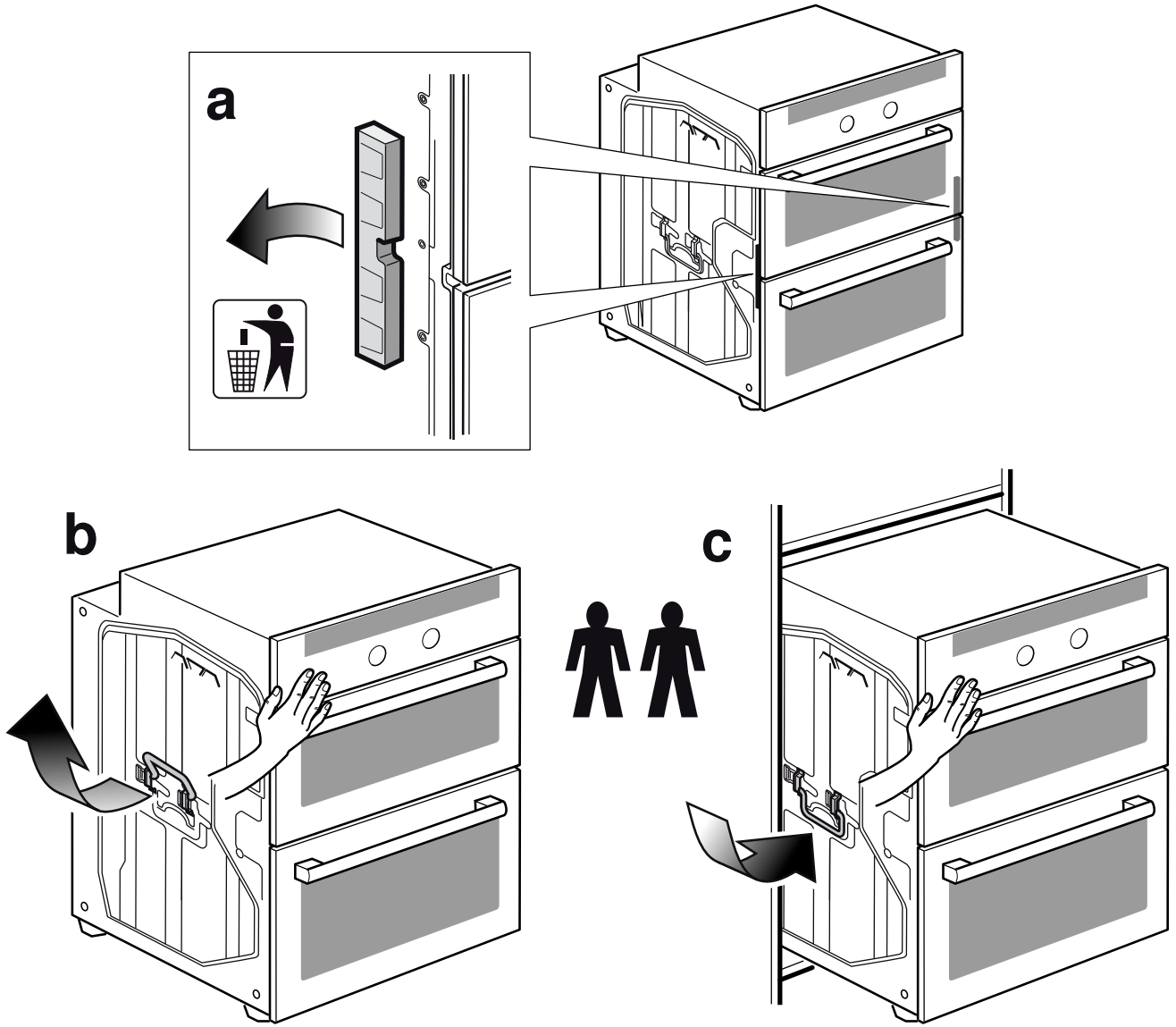

5

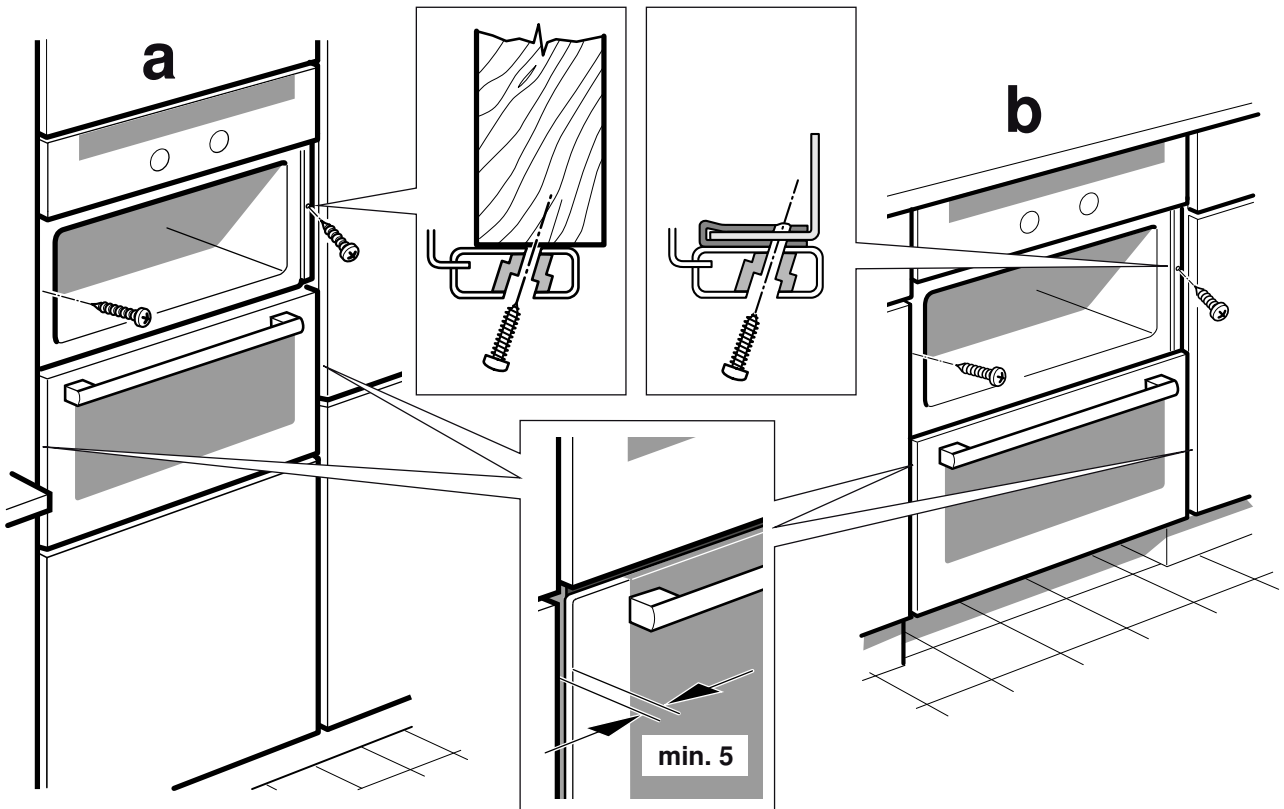

## Important information

- The safe operation of this appliance can only be guaranteed if it has been installed to a professional standard in accordance with these installation instructions. The installer shall be liable for any damage resulting from incorrect installation.
- Do not use the door handle to transport or install the appliance.
- The appliance must be transported by two people using the carry handles on either side – figure 4b.
- Check the appliance for damage after unpacking it. Do not connect the appliance if it has been damaged in transit.
- Proceed in accordance with the installation sheets for installing accessories.
- Before starting up the appliance, remove any packaging material and adhesive film from the cooking compartment and the door.
- Fitted units must be heat-resistant up to 90 °C, and adjacent unit fronts up to 65 °C.
- Do not install the appliance behind a decorative door or the door of a kitchen unit, as this may cause the appliance to overheat.
- Any cut-outs that need to be made in the units should be made before the appliance is installed. Remove any shavings, as they may prevent the electrical components from working properly.
- Wear protective gloves so that you do not cut yourself. Parts that are accessible during installation may have sharp edges.
- The mains socket for the appliance must either be located in the hatched area **A** or outside of the area where the appliance is installed.
- Secure any unsecured units to the wall using a standard bracket **B**.
- The dimensions in the figures are in mm.

### Corner installation – Fig. 1

To ensure that the appliance door can be opened in a corner installation, take account of the dimensions. Dimension **C** is dependent on the thickness of the furniture panel under the handle.

### Appliance in a tall unit – fig. 2

To ventilate the appliance, there must be a gap of 20 mm between all intermediate floors and the wall.

If the tall unit has another back panel in addition to the element back panels, this must be removed.

Do not fit the appliance too high up; it must be possible for accessories to be removed easily.

Remove the angle bracket prior to installation and refit the screws (fig. 2a and 2b).

**Note:** The angle bracket is not required for installation in a tall unit; it is only required for installation under a worktop.

### Appliance under worktop without furniture units – Fig. 3

The gap between the worktop and the appliance must not be sealed by additional strips.

1. Secure the worktop to the fitted unit.
2. Remove the angle bracket and bearing rails prior to installation and refit the screws (Fig. 3a and 3b).
3. Screw in the angle bracket and bearing rails so that they are flush with the furniture unit. Align the bearing rails horizontally (Fig. 3c to 3f).
4. If the appliance is installed under a hob, the following minimum dimensions must be adhered to (including substructure, if applicable):

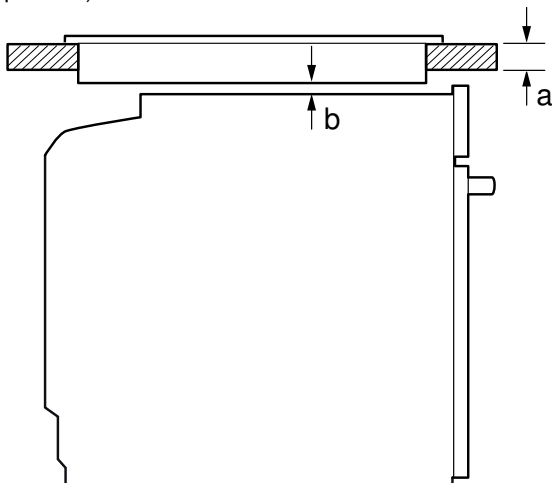

Hob type	a	a	b
	raised	flush-mounted	
Induction hob	39 mm	40 mm	5 mm
Full-surface induction hob	49 mm	50 mm	5 mm
Induction hob			
Gas hob	29 mm	40 mm	5 mm
Electric hob	29 mm	32 mm	2 mm

The minimum worktop thickness **a** is based on the required minimum clearance **b**.

Proceed in accordance with the installation instructions for the hob.

## Connecting the appliance to the electricity supply

The appliance corresponds to protection class I and must only be operated with a protective earth connection.

The fuse protection must correspond to the power rating specified on the appliance's rating plate and to local regulations.

The appliance must be disconnected from the power supply whenever installation work is being carried out.

When the appliance is installed, protection must be provided against accidental contact in the future.

Only a licensed professional may connect the appliance.

In the permanent electrical wiring, an energy-isolating device must be provided in the phases in accordance with the installation requirements. Identify the live and neutral conductors in the mains socket. The appliance may be damaged if it is not connected correctly.

Only connect the appliance as shown in the connection diagram. See the rating plate for the voltage.

## Securing the appliance

- Do not use the door handle to transport or install the appliance.
  - The appliance must be transported by two people using the carry handles on either side – figure 4b.
1. Remove the transport locks on each side and throw them away – Figure 4a.
  2. Carry the appliance by the carry handles on each side. Support the front of the appliance with your hand when doing so – Figure 4b.
  3. Place the appliance in the unit and fold the carry handles back down before pushing it in – Figure 4c.
  4. Push the appliance in fully. Do not kink or trap the connection cable when doing so, or route it over sharp edges.
  5. Centre the appliance – Figure 5.
    - There must be an air gap of 5 mm between the appliance and the adjacent furniture panels.
  6. Use a spirit level to position the appliance so that it is perfectly level.
  7. Secure the appliance in a tall unit using the wooden screws supplied in the cooking compartment - Fig. 5a.
    - Secure the appliance under the worktop using the metal screws supplied in the bag - Fig. 5b.

## Removal

1. Disconnect the appliance from the power supply.
2. Undo the securing screws.
3. Lift the appliance slightly and pull it out completely.