

▶ RCB53724MW
RCB53724MX
RCB53724VW
RCB53724VX

EN **User Manual**
Fridge Freezer

USER MANUAL



AEG

CONTENTS

1. SAFETY INFORMATION.....	2
2. SAFETY INSTRUCTIONS.....	4
3. CONTROL PANEL.....	6
4. DAILY USE.....	7
5. CARE AND CLEANING.....	8
6. TROUBLESHOOTING.....	9
7. INSTALLATION.....	12
8. TECHNICAL DATA.....	13

FOR PERFECT RESULTS

Thank you for choosing this AEG product. We have created it to give you impeccable performance for many years, with innovative technologies that help make life simpler features you might not find on ordinary appliances. Please spend a few minutes reading to get the very best from it.

Visit our website for:



Get usage advice, brochures, trouble shooter, service information:

www.aeg.com/webselfservice



Register your product for better service:

www.registeraeg.com



Buy Accessories, Consumables and Original spare parts for your appliance:

www.aeg.com/shop

CUSTOMER CARE AND SERVICE

Always use original spare parts.

When contacting our Authorised Service Centre, ensure that you have the following data available: Model, PNC, Serial Number.

The information can be found on the rating plate.

 Warning / Caution-Safety information

 General information and tips

 Environmental information

Subject to change without notice.

1. SAFETY INFORMATION

Before the installation and use of the appliance, carefully read the supplied instructions. The manufacturer is not responsible for any injuries or damages that are the result of incorrect installation or usage. Always keep the instructions in a safe and accessible location for future reference.

1.1 Children and vulnerable people safety

- This appliance can be used by children aged from 8 years and above and persons with reduced physical, sensory or mental capabilities or lack of experience and knowledge if they have been given supervision or instruction concerning the use of the appliance in a safe way and understand the hazards involved.
- This appliance may be used by children between 3 and 8 years of age and persons with very extensive and complex disabilities, if they have been properly instructed.
- Children of less than 3 years of age should be kept away unless continuously supervised.
- Do not let children play with the appliance.
- Children shall not carry out cleaning and user maintenance of the appliance without supervision.
- Keep all packaging away from children and dispose of it appropriately.

1.2 General Safety

- This appliance is intended to be used in household and similar applications such as:
 - Farm houses; staff kitchen areas in shops, offices and other working environments
 - By clients in hotels, motels, bed and breakfast and other residential type environments
- Keep ventilation openings, in the appliance enclosure or in the built-in structure, clear of obstruction.
- Do not use mechanical devices or other means to accelerate the defrosting process, other than those recommended by the manufacturer.
- Do not damage the refrigerant circuit.
- Do not use electrical appliances inside the food storage compartments of the appliance, unless they are of the type recommended by the manufacturer.
- Do not use water spray and steam to clean the appliance.

- Clean the appliance with a moist soft cloth. Only use neutral detergents. Do not use abrasive products, abrasive cleaning pads, solvents or metal objects.
- Do not store explosive substances such as aerosol cans with a flammable propellant in this appliance.
- If the supply cord is damaged, it must be replaced by the manufacturer, its Authorised Service Centre or similarly qualified persons in order to avoid a hazard.

2. SAFETY INSTRUCTIONS

2.1 Installation



WARNING!

Only a qualified person must install this appliance.

- Remove all the packaging and the transit bolts.
- Do not install or use a damaged appliance.
- Follow the installation instructions supplied with the appliance.
- Always take care when moving the appliance as it is heavy. Always use safety gloves and enclosed footwear.
- Make sure the air can circulate around the appliance.
- At first installation or after reversing the door wait at least 4 hours before connecting the appliance to the power supply. This is to allow the oil to flow back in the compressor.
- Before carrying out any operations on the appliance (e.g. reversing the door), remove the plug from the power socket.
- Do not install the appliance close to radiators or cookers, ovens or hobs.
- Do not install the appliance where there is direct sunlight.
- Do not install this appliance in areas that are too humid or too cold.
- When you move the appliance, lift it by the front edge to avoid scratching the floor.

2.2 Electrical connection



WARNING!

Risk of fire and electric shock.

- The appliance must be earthed.
- Make sure that the parameters on the rating plate are compatible with the electrical ratings of the mains power supply.
- Always use a correctly installed shockproof socket.
- Do not use multi-plug adapters and extension cables.
- Make sure not to cause damage to the electrical components (e.g. mains plug, mains cable, compressor). Contact the Authorised Service Centre or an electrician to change the electrical components.
- The mains cable must stay below the level of the mains plug.
- Connect the mains plug to the mains socket only at the end of the installation. Make sure that there is access to the mains plug after the installation.
- Do not pull the mains cable to disconnect the appliance. Always pull the mains plug.

2.3 Use



WARNING!

Risk of injury, burns, electric shock or fire.

- Do not change the specification of this appliance.

- Do not put electrical appliances (e.g. ice cream makers) in the appliance unless they are stated applicable by the manufacturer.
- Be careful not to cause damage to the refrigerant circuit. It contains isobutane (R600a), a natural gas with a high level of environmental compatibility. This gas is flammable.
- If damage occurs to the refrigerant circuit, make sure that there are no flames and sources of ignition in the room. Ventilate the room.
- Do not let hot items to touch the plastic parts of the appliance.
- Do not put soft drinks in the freezer compartment. This will create pressure on the drink container.
- Do not store flammable gas and liquid in the appliance.
- Do not put flammable products or items that are wet with flammable products in, near or on the appliance.
- Do not touch the compressor or the condenser. They are hot.
- Do not remove or touch items from the freezer compartment if your hands are wet or damp.
- Do not freeze again food that has been thawed.
- Obey the storage instructions on the packaging of frozen food.
- Before maintenance, deactivate the appliance and disconnect the mains plug from the mains socket.
- This appliance contains hydrocarbons in the cooling unit. Only a qualified person must do the maintenance and the recharging of the unit.
- Regularly examine the drain of the appliance and if necessary, clean it. If the drain is blocked, defrosted water collects in the bottom of the appliance.

2.6 Service

- To repair the appliance contact an Authorised Service Centre.
- Use original spare parts only.

2.7 Disposal



WARNING!

Risk of injury or suffocation.

- Disconnect the appliance from the mains supply.
- Cut off the mains cable and discard it.
- Remove the door to prevent children and pets to be closed inside of the appliance.
- The refrigerant circuit and the insulation materials of this appliance are ozone-friendly.
- The insulation foam contains flammable gas. Contact your municipal authority for information on how to discard the appliance correctly.
- Do not cause damage to the part of the cooling unit that is near the heat exchanger.

2.4 Internal lighting



WARNING!

Risk of electric shock.

- The type of lamp used for this appliance is for household appliances only. Do not use it for house lighting.

2.5 Care and cleaning



WARNING!

Risk of injury or damage to the appliance.

3. CONTROL PANEL

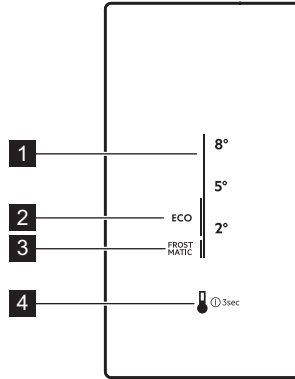

- 1 Temperature scale
- 2 ECO mode icon
- 3 FROSTMATIC icon

- 4 Temperature key

3.1 Switching on

1. Plug the appliance into electrical mains socket.
2. To turn on the appliance, touch the temperature key until all LED indicators light up.

i After approximately 3 seconds LED indicators fade and the temperature is set to the default setting (ECO mode). LED indicator next to ECO mode icon illuminates.

key repeatedly until the required temperature is selected. The setting will be fixed.

i Selection is progressive, varying from +2°C to +8°C.
 Coldest setting: +2°C.
 Warmest setting: +8°C
 Most suitable setting: ECO mode (+3 to +4°C).

Choose the setting keeping in mind that the temperature inside the appliance depends on:

- room temperature
- frequency of opening the door
- quantity of food stored
- appliance location.

3.2 Switching off

1. To switch off the appliance press the temperature key for 3 seconds.

All LED indicators turn off.

2. To disconnect the appliance from the electrical supply, remove the mains plug from the power socket.

3.3 Temperature regulation

To regulate the temperature, press the temperature key. Every time the key is pressed, the set temperature moves by 1 position and corresponding LED indicator lights up. Press the temperature

3.4 Sleep mode of the display

After 30 seconds of no interaction with the appliance, the display goes into the sleep mode. Only LED indicator corresponding to currently set temperature illuminates in low light. All other LED indicators are off. To deactivate this mode press the temperature key.

3.5 ECO mode

In this mode the temperature is set between +3 and +4°C.

-  This is the best temperature to ensure good food preservation with minimal energy consumption.

To activate ECO mode press the temperature key repeatedly until LED indicator next to ECO mode icon lights up.

3.6 FROSTMATIC function

If you need to insert a large amount of warm food into fridge compartment (for example after doing the grocery shopping) or rapidly decrease the temperature in the freezer compartment to freeze fresh food quickly, we suggest activating FROSTMATIC function for proper food storage.

To activate this function press the temperature key repeatedly until the LED indicator next to FROSTMATIC icon lights up. Also LED indicator corresponding to +2°C illuminates.

-  This function stops automatically after 52 hours. When the function deactivates, the previous temperature setting is restored.

-  You can deactivate this function at any time by pressing the temperature key and choosing a new temperature setting.

-  This function corresponds both to fridge and freezer compartment.

3.7 Door open indicator

If the door has been left open for approximately 5 minutes, the door open indicator activates. The temperature key and LED indicator of the currently set temperature flash.

-  You can deactivate this indicator by closing the door or by pressing the temperature key.

4. DAILY USE

4.1 Freezing fresh food

The freezer compartment is suitable for freezing fresh food and storing frozen and deep-frozen food for a long time.

To freeze fresh food activate the FROSTMATIC function at least 24 hours before placing the food to be frozen in the freezer compartment.

Place the fresh food to be frozen in the bottom compartment.

The maximum amount of food that can be frozen in 24 hours is specified on the **rating plate**, a label located on the inside of the appliance.

The freezing process lasts 24 hours: during this period do not add other food to be frozen.

When the freezing process is completed, return to the required temperature (see "FROSTMATIC Function").

-  In this condition, the refrigerator compartment temperature might drop below 0°C. If this occurs reset the temperature regulator to a warmer setting.

4.2 Storage of frozen food

When first starting-up or after a period out of use, before putting the products in the compartment let the appliance run at least 2 hours with the FROSTMATIC function turned on.

If large quantities of food are to be stored, remove all drawers from appliance and place food on glass shelf to obtain the best performance.



In the event of accidental defrosting, for example due to a power failure, if the power has been off for longer than the value shown in the technical data chart under "Rising time", the defrosted food must be consumed quickly or cooked immediately and then re-frozen (after cooling).

4.3 Storage of the food in a filter compartment

Cover or wrap the food, particularly if it has a strong flavour.

Position the food so that air can circulate freely around it.

Keep the food on all shelves no closer than 20 mm from the rear wall and 15 mm from the door.

4.4 PROFRESH PLUS

The refrigerator compartment is equipped with a device that allows rapid cooling of food and keeps a more uniform temperature in the compartment.

This device activates automatically when needed, for example when the temperature inside the appliance is high.

4.5 CLEANAIR CONTROL filter

This active carbon filter absorbs bad odours and maintains the best flavour and aroma for all the food stored in the refrigerator compartment.

On delivery the filter is in a plastic bag.

To install the filter in the appliance:

1. Take off the filter cover.

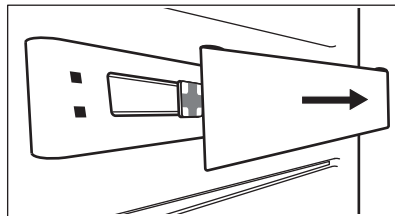

2. Take out the filter from the plastic bag.
3. Insert the filter in the slot in the rear wall of the appliance.

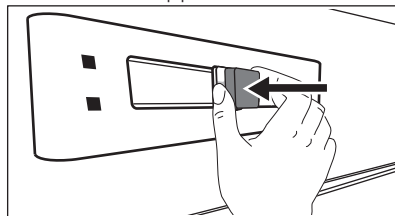

4. Put on the filter cover.

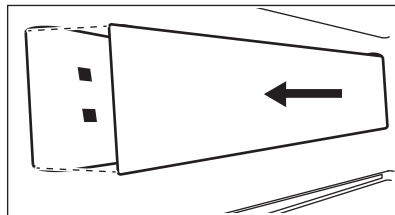

CAUTION!

Make sure that the filter cover is always closed so that the filter functions correctly.

To get the best performance the filter should be changed once every 6 months. New active filter can be purchased from your local dealer or through the website. The part number is printed on the plastic bag.

5. CARE AND CLEANING



WARNING!

Refer to Safety chapters.

5.1 Cleaning the interior

Before using the appliance for the first time, the interior and all internal accessories should be washed with lukewarm water and some neutral soap

to remove the typical smell of a brand-new product, then dried thoroughly.



CAUTION!

Do not use detergents, abrasive powders, chlorine or oil-based cleaners as they will damage the finish.

5.2 Periodic cleaning



CAUTION!

Do not pull, move or damage any pipes and/or cables inside the cabinet.



CAUTION!

Take care of not to damage the cooling system.



CAUTION!

When moving the cabinet, lift it by the front edge to avoid scratching the floor.

The equipment has to be cleaned regularly:

1. Clean the inside and accessories with lukewarm water and some neutral soap.
2. Regularly check the door seals and wipe clean to ensure they are clean and free from debris.
3. Rinse and dry thoroughly.
4. If accessible, clean the condenser and the compressor at the back of the appliance with a brush.
This operation will improve the performance of the appliance and save electricity consumption.

5.3 Defrosting

Your appliance is frost free. This means that there is no build up of frost when it is in operation, neither on the internal walls nor on the foods. The absence of frost is due to the continuous circulation of cold air inside the compartment, driven by an automatically controlled fan. The defrost water drains out through a trough into a special container at the back of the appliance, over the motor compressor, where it evaporates.

It is important to periodically clean the defrost water drain hole in the middle of the refrigerator compartment channel to prevent the water overflowing and dripping onto the food inside.

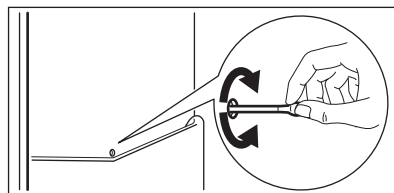

5.4 Periods of non-operation

When the appliance is not in use for long periods, take the following precautions:

1. Disconnect the appliance from electricity supply.
2. Remove all food.
3. Clean the appliance and all accessories.
4. Leave the door/doors open to prevent unpleasant smells.

6. TROUBLESHOOTING



WARNING!

Refer to Safety chapters.

6.1 What to do if...

Problem	Possible cause	Solution
The appliance is noisy.	The appliance is not supported properly.	Check if the appliance stands stable.

Problem	Possible cause	Solution
Audible or visual alarm is on.	The cabinet has been recently switched on or the temperature is still too high.	Refer to "Door Open Alarm" or "High Temperature Alarm".
	The temperature in the appliance is too high.	Refer to "Door Open Alarm" or "High Temperature Alarm".
The lamp does not work.	The lamp is in stand-by mode.	Close and open the door.
The lamp does not work.	The lamp is defective.	Contact the nearest Authorised Service Centre.
The compressor operates continually.	Temperature is set incorrectly.	Refer to "Operation"/"Control panel" chapter.
	Many food products were put in at the same time.	Wait a few hours and then check the temperature again.
	The room temperature is too high.	Refer to climate class chart on the rating plate.
	Food products placed in the appliance were too warm.	Allow food products to cool to room temperature before storing.
The compressor does not start immediately after pressing the FROSTMATIC or after changing the temperature.	The FROSTMATIC function is switched on.	Refer to "FROSTMATIC function".
	This is normal, no error has occurred.	The compressor starts after some time.
Water flows inside the refrigerator.	The water outlet is clogged.	Clean the water outlet.
	Food products prevent water from flowing into the water collector.	Make sure that food products do not touch the rear plate.
Water flows on the floor.	The melting water outlet is not connected to the evaporative tray above the compressor.	Attach the melting water outlet to the evaporative tray.

Problem	Possible cause	Solution
Temperature cannot be set.	The FROSTMATIC or COOLMATIC function is switched on.	Switch off FROSTMATIC or COOLMATIC manually, or wait until the function resets automatically to set the temperature. Refer to "FROSTMATIC or COOLMATIC function".
The temperature in the appliance is too low/too high.	The temperature regulator is not set correctly.	Set a higher/lower temperature.
	The food products temperature is too high.	Let the food products temperature decrease to room temperature before storage.
	Many food products were stored at the same time.	Store less food products at the same time.
Side panels of the appliance are warm.	The FROSTMATIC function is switched on.	Refer to "FROSTMATIC function".
	This is a normal state caused by operation of the heat exchanger.	Make sure that there is at least 30 mm of space between each side of the appliance and the surrounding furniture when the ambient temperature exceeds 38°C.
There is too much condensed water on the rear wall of the refrigerator.	Door was opened too frequently.	Open the door only when necessary.
	Door was not closed completely.	Make sure the door is closed completely.
	Stored food was not wrapped.	Wrap food in suitable packaging before storing it in the appliance.
Door does not open easily.	You attempted to re-open the door immediately after closing.	Wait a few seconds between closing and re-opening of the door.



If the advice does not lead to the desired result, contact the nearest Authorised Service Centre.

Only service is allowed to replace the lighting device. Contact your Authorised Service Centre.

6.2 Replacing the lamp

The appliance is equipped with a longlife LED interior light.

7. INSTALLATION



WARNING!
Refer to Safety chapters.

7.1 Positioning

This appliance can be installed in a dry, well ventilated indoor where the ambient temperature corresponds to the climate class indicated on the rating plate of the appliance:

Climate class	Ambient temperature
SN	+10°C to + 32°C
N	+16°C to + 32°C
ST	+16°C to + 38°C
T	+16°C to + 43°C

7.2 Location



It must be possible to disconnect the appliance from the mains power supply. The plug must therefore be easily accessible after installation.

The appliance should be installed well away from sources of heat such as radiators, boilers, direct sunlight etc. Ensure that air can circulate freely around the back of the cabinet. To ensure best performance, if the appliance is positioned below an overhanging wall unit, the minimum distance between the top of the cabinet and the wall unit must be at least 100mm. Ideally, however, the appliance should not be positioned below overhanging wall units. One or more adjustable feet at the base of the cabinet ensure that the appliance stands level.

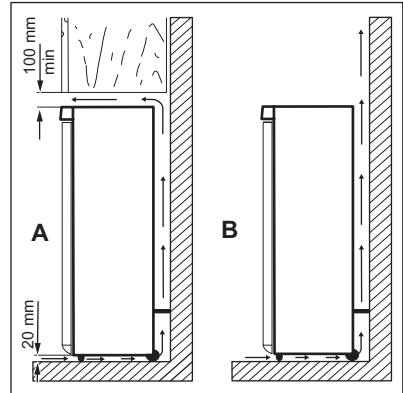

CAUTION!
In order to guarantee proper functioning in ambient temperature above 38°C, it is advised to have a 30mm separation between the sides of the appliance and surrounding furniture.

7.3 Levelling

When placing the appliance ensure that it stands level. This can be achieved by two adjustable feet at the bottom in front.

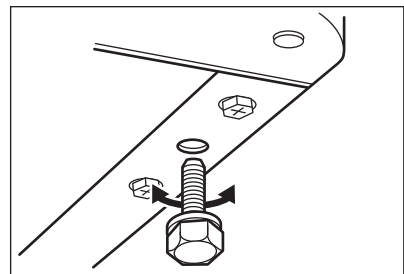

7.4 Electrical Connection



CAUTION!

Any electrical work required to install this appliance should be carried out by a qualified electrician or competent person.



WARNING!

This appliance must be earthed. The manufacturer declines any liability should these safety measures not be observed.

The wires in the mains lead are coloured in accordance with the following code:

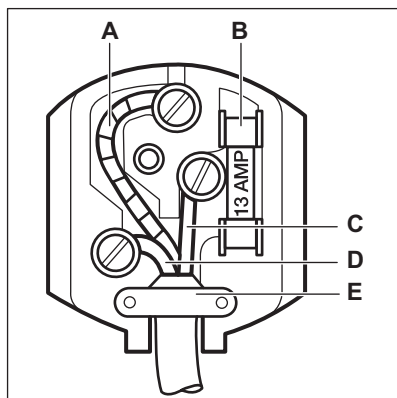

- **A** - green and yellow: Earth
- **C** - brown: Live
- **D** - blue: Neutral

As the colours of the wires in the mains lead of this appliance may not

correspond with the coloured markings identifying the terminals in your plug, proceed as follows:

1. Connect the wire coloured green and yellow to the terminal marked either with the letter "E" or by the earth symbol \oplus or coloured green and yellow.
2. Connect the wire coloured blue to the terminal either marked with the letter "N" or coloured black.
3. Connect the wire coloured brown to the terminal either marked with the "L" or coloured red.
4. Check that no cut, or stray strands of wire is present and the cord clamp (**E**) is secure over the outer sheath. Make sure the electricity supply voltage is the same as that indicated on the appliance rating plate.
5. Switch on the appliance.

The appliance is supplied with a 13 amp fuse (**B**). In the event of having to change the fuse in the plug supplied, a 13 amp ASTA approved (BS 1362) fuse must be used.



WARNING!

A cut off plug inserted into a 13 amp socket is a serious safety (shock) hazard. Ensure that it is disposed of safely.

7.5 Door reversibility

If you want to change the opening direction of the door, contact the nearest Authorised Service Centre. The Authorised Service specialist will reverse the door swing at your cost.

8. TECHNICAL DATA

Height	2005 mm
Width	595 mm
Depth	647 mm
Rising time	20 h

Voltage	230 - 240 V
Frequency	50 Hz

The technical information is situated in the rating plate, on the external or internal side of the appliance and in the energy label.

9. ENVIRONMENTAL CONCERNS

Recycle materials with the symbol .
Put the packaging in relevant containers to recycle it. Help protect the environment and human health by recycling waste of electrical and electronic appliances. Do not dispose of

appliances marked with the symbol  with the household waste. Return the product to your local recycling facility or contact your municipal office.

www.aeg.com/shop



280157419-A-492017



AEG