

SAMSUNG

E-MANUAL

Thank you for purchasing this Samsung product.
To receive more complete service, please register
your product at

www.samsung.com

Model _____ Serial No. _____

To directly go to the page that provides instructions
on how to use the manual for visually impaired
users, select the Menu Learning Screen link below.
["Menu Learning Screen" Link](#)

Contents

Quick Guides

Connecting the Samsung Smart Remote to the TV

Using Smart Hub

Using the Ambient Mode

- 10 Entering Ambient Mode
- 10 Ambient Mode browser screen
- 13 Applying effects to the content
- 13 View detailed information about the content
- 13 Entering the TV viewing screen from Ambient Mode

Using the Shortcuts

- 15 Adding channels
- 15 Moving channels
- 15 Removing a channels

Using Bixby

- 16 Starting Bixby with voice
- 16 Starting Bixby using buttons on the Samsung Smart Remote
- 17 Learning about the Explore Bixby Screen
- 18 Read Before Using Bixby
- 19 Provisions for using Bixby

Updating the TV's Software

- 20 Updating through the Internet
- 20 Updating through a USB device
- 20 Updating the TV automatically

Getting Support

- 21 Getting support through Remote Management
- 21 Finding the contact information for service
- 21 Requesting service

Connections

Connection Guide

Connecting an Antenna (Aerial)

Connecting to the Internet

- 24 Establishing a wired Internet connection
- 25 Establishing a wireless Internet connection

- 26 Checking the Internet connection status
- 26 Resetting Your Network
- 26 Turning on the TV with a mobile device
- 26 Connecting an IP control device to the TV
- 26 Changing the name of the TV on a network

Connection Cables for External Devices

Switching between external devices connected to the TV

- 29 Editing the name and icon of an external device
- 30 Using additional functions

Connection Notes

- 31 Connection notes for HDMI
- 32 Connection notes for audio devices
- 33 Connection notes for computers
- 33 Connection notes for mobile devices

Remote Control and Peripherals

About the Samsung Smart Remote (QLED and SERIF TVs)

About the Samsung Smart Remote (UHD TV)

About the Samsung Smart Remote (THE FRAME)

Connecting the Samsung Smart Remote to the TV

Controlling External Devices with a Samsung Remote Control - Using the Universal Remote

Using Anynet+ (HDMI-CEC)

- 45 Connecting an external device through Anynet+ and using their menus
- 45 Read before connecting an Anynet+ (HDMI-CEC) device

Controlling the TV with a Keyboard, Mouse, or Gamepad

- 46 Connecting a USB keyboard, Mouse, or gamepad
- 46 Connecting a Bluetooth keyboard, Mouse, or gamepad
- 47 Using the keyboard and mouse
- 48 Setting up the input devices

Entering Text using the On-Screen Virtual Keyboard

- 49 Entering Text using the remote control's microphone and the on-screen Virtual keyboard

Smart Features

Using Smart Hub

- 51 Displaying the Home Screen
- 56 Launching Smart Hub automatically
- 56 Launching the last used app automatically
- 56 Testing Smart Hub connections
- 56 Resetting Smart Hub

Using a Samsung account

- 57 Signing in to a Samsung account
- 57 Creating a new account
- 57 Creating a Samsung account using a PayPal account
- 58 Managing your Samsung account

Using the Ambient Mode

- 59 Entering Ambient Mode
- 59 Ambient Mode browser screen
- 62 Applying effects to the content
- 62 View detailed information about the content
- 62 Entering the TV viewing screen from Ambient Mode

Using the Remote Access

Using the APPS Service

- 65 Installing an app
- 65 Launching an app
- 66 Managing installed apps

Using the Gallery App

Using the Universal Guide App

Using the SmartThings App

Using the e-Manual

- 72 Launching the e-Manual
- 72 Using the buttons in the e-Manual

Using the Internet

Playing pictures/video/music

- 75 Playing multimedia content on a PC or mobile device
- 76 Playing multimedia content on a USB device
- 76 Listening to your mobile device sound through the TV speaker using Sound Mirroring
- 77 Buttons and functions available while playing multimedia content

Using Bixby

- 80 Starting Bixby with voice
- 80 Starting Bixby using buttons on the Samsung Smart Remote
- 81 Learning about the Explore Bixby Screen
- 82 Read Before Using Bixby
- 83 Provisions for using Bixby

TV Viewing

Using the Guide

Recording Programmes

- 87 Using the instant and schedule recording options from the Guide screen
- 87 Using the instant and schedule recording options while watching a programme
- 88 Scheduling a video recording after entering the date and time
- 88 Managing the schedule recording list
- 89 Viewing recorded programmes
- 89 Setting up a schedule recording start

Setting Up a Schedule Viewing

- 89 Using the schedule viewing options from the guide screen
- 90 Using the schedule viewing options while watching a programme
- 90 Using schedule viewing to view programmes at a specified time on a specified date
- 90 Setting the Schedule Viewing Time

Using Timeshift

Buttons and functions available while recording a programme or Timeshift

Using the Channel List

Editing channels

Using a Personal Favourites List

- 96 Viewing and selecting channels on Favourites list only
- 96 Create a favourites list

TV-Viewing Support Functions

- 97 Changing the broadcast signal
- 97 Scanning for available channels
- 98 Checking digital channel signal info and strength
- 98 Restricting Viewing to Specific Channels
- 99 Using Mark Adult Channels
- 99 Selecting the broadcasting audio option
- 99 Using Programme Rating Lock
- 100 Showing common interface menu
- 100 Configuring advanced broadcasting settings
- 101 Tuning broadcast signals manually
- 101 Fine-tuning analogue broadcasts
- 101 Transferring channel list
- 102 Enabling/Disabling Edit Channel Numbers
- 102 Deleting CAM operator profile
- 102 Setting satellite system
- 102 Changing teletext language
- 103 Selecting the broadcast audio language
- 103 Showing TVkey Interface menu
- 103 Reading digital text

Picture and Sound

Using the Intelligent Mode

Adjusting the Picture Quality

- 105 Choosing a picture mode
- 106 Configuring advanced picture settings

Setting the Viewing Environment for External Devices

- 107 Playing games on an optimised screen
- 108 Setting the Game Mode details
- 109 Using Input Signal Plus
- 109 Using HDMI black level

Picture Support Functions

- 110 Viewing a picture-in-picture (PIP)
- 110 Changing the picture size
- 111 Changing the picture size automatically
- 111 Changing the picture size in 4:3 or Screen Fit mode
- 111 Fitting the picture to the screen
- 111 Adjusting the picture size and/or position

Configuring a Sound Mode and Expert Settings

- 112 Choosing a sound mode
- 112 Configuring advanced sound settings

Using the Sound Support Functions

- 113 Selecting speakers
- 113 Listening to the TV through Bluetooth devices
- 114 Listening to the TV through a Samsung audio device that supports the Wi-Fi function

System and Support

Using the Time Functions and the Timers

- 115 Setting the clock automatically
- 116 Setting the clock manually
- 116 Adjusting the clock for DST and time zone
- 117 Changing the current time
- 117 Using the sleep timer
- 117 Turning off the TV using the off timer

Using the Auto Protection Time and Energy Saving Functions

- 118 Setting the Auto Protection Time
- 118 Reducing the energy consumption of the TV

Updating the TV's Software

- 119 Updating through the Internet
- 119 Updating through a USB device
- 119 Updating the TV automatically

Protecting the TV from Hacking and Malicious Code

- 120 Scanning the TV and connected storage for malicious code

Audio and Video Functions for the Visually or Hearing Impaired

- 121 Running the accessibility functions
- 121 Running Accessibility Shortcuts
- 121 Enabling voice guides for the visually impaired
- 122 Changing the volume, speed, and pitch of the Voice Guide
- 122 Audio Description
- 122 White text on black background (high contrast)
- 122 Setting the screen to a black and white tone

- 123 Inverting the screen colour
- 123 Enlarging the font (for the visually impaired)
- 123 Learning about the remote control (for the visually impaired)
- 123 Learning about the TV menu
- 124 Watching TV broadcasts with subtitles
- 124 Selecting the broadcasting subtitle language
- 124 Listening to the TV through Bluetooth devices (for the hearing impaired)
- 125 Enlarging the sign language screen for the hearing impaired
- 125 Configuring the repeat settings for remote control buttons

Using Other Functions

- 125 Changing the menu language
- 125 Setting up a password
- 126 Selecting Usage or Retail Mode
- 126 Managing External Devices
- 126 Using AirPlay
- 126 Restoring the TV to the factory settings

HbbTV

Using a TV Viewing Card ("CI or CI+ Card")

- 128 Connecting the "CI or CI+ Card" via COMMON INTERFACE slot with the CI CARD Adapter
- 129 Connecting the "CI or CI+ Card" via COMMON INTERFACE slot
- 129 Using the "CI or CI+ Card"

Teletext Feature

- 130 On the Samsung Smart Remote
- 132 On the standard remote control
- 133 Typical Teletext page

Troubleshooting

Picture Issues

- 134 Testing the picture

Sound and Noise Issues

- 137 Testing the sound

Channel and Broadcast Issues

External Device Connectivity Issues

Network Issues

Anynet+ (HDMI-CEC) Issues

Remote Control Issues

Recording Issues

Apps

Media Files

Voice Recognition Issues

Other issues

Diagnosing TV operational issues

Getting Support

- 148 Getting support through Remote Management
- 148 Finding the contact information for service
- 148 Requesting service

Precautions and Notes

Before Using the Recording and Timeshift Functions

- 149 Before using the recording and schedule recording functions
- 151 Before using the timeshift function

Supported broadcasting audio options

Read Before Using APPS

Read Before Using the Internet Function

- 154 Read before setting up a wireless Internet connection

Read Before Playing Photo, Video, or Music Files

- 155 Limitations on use of photo, video, and music files
- 156 Supported subtitles
- 157 Supported image formats and resolutions
- 157 Supported music formats and codecs
- 158 Video codecs supported by RU8 model series or higher
- 159 Video codecs supported by RU7 model series or lower
- 161 Video codecs supported by Q900RB model series

Read After Installing the TV

- 163 Picture sizes and input signals
- 164 Installing an anti-theft lock

Supported Resolutions for UHD Input Signals

- 164 If Input Signal Plus is set to Off
- 165 If Input Signal Plus is set to On

Resolutions for Input Signals supported by Q900RB model series

- 166 If Input Signal Plus is set to On

Supported Resolutions for FreeSync

Read Before Connecting a Computer (Supported Resolutions)

- 167 IBM
- 167 MAC
- 168 VESA DMT
- 169 VESA CVT
- 169 CTA-861

Supported Resolutions for Video Signals

- 170 CTA-861
- 171 VESA CVT

Read Before Using Bluetooth Devices

- 172 Restrictions on using Bluetooth

Licences

Accessibility Guidance

Menu Learning Screen

Using the Remote control

- 174 Orientation of the Samsung Smart Remote
- 174 Description of the Samsung Smart Remote

Using the accessibility menu

- 176 Running the Accessibility Shortcuts menu
- 177 Running the Accessibility menu functions using the General menu
- 177 Running the Accessibility menu functions using Bixby
- 178 Learning about the Accessibility menu functions

Using the TV with Voice Guide on

- 180 Changing channel
- 180 Using on-screen number entry via the Samsung Smart Remote
- 181 Changing volume
- 181 Using programme information

Using the guide

- 183 To view a programme on now
- 183 Other options in the guide

Using Schedule Viewing

- 185 Setting up a schedule viewing
- 185 Cancelling a scheduled viewing

Using the Channel List

Recording

- 188 Using the instant and schedule recording options from the guide screen:
- 189 Recording the programme you are watching
- 189 Scheduling recording from the programme info window
- 189 Changing the recording time
- 190 Viewing recorded programmes
- 190 Deleting a recorded programme

Using Smart Hub

- 191 Smart Hub
- 192 Using the Smart Hub home screen

Launching the e-Manual

Using Bixby



- 195 Running Bixby

Quick Guides





You can learn quickly how to run and use the frequently used functions, such as Bixby, Ambient Mode, and Smart Hub.

Connecting the Samsung Smart Remote to the TV

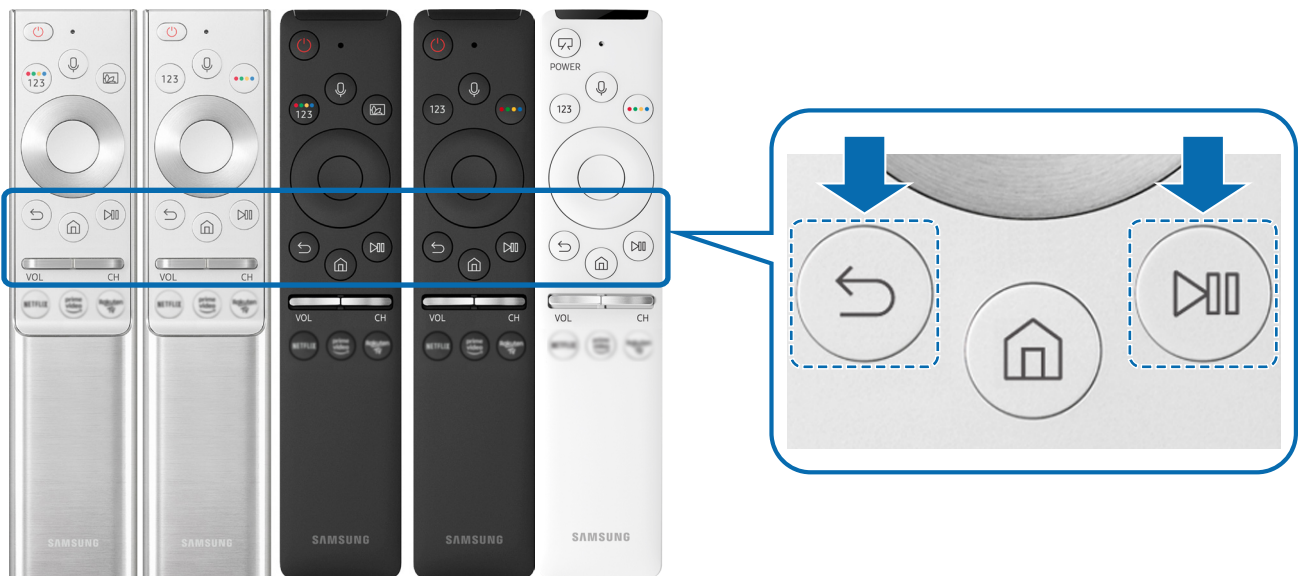
Connect the Samsung Smart Remote to your TV to operate the TV.

When you turn on the TV for the first time, the Samsung Smart Remote pairs to the TV automatically. If the Samsung Smart Remote does not pair to the TV automatically, point it at the front of the TV, and then press and hold the  and  buttons simultaneously for 3 seconds or more.



-  [The images, buttons, and functions of the Samsung Smart Remote may differ with the model or geographical area.](#)
-  For more information about the Samsung Smart Remote that comes with the QLED and SERIF TV, refer to "[About the Samsung Smart Remote \(QLED and SERIF TVs\)](#)".
-  For more information about the Samsung Smart Remote that comes with the UHD TV, refer to "[About the Samsung Smart Remote \(UHD TV\)](#)".
-  For more information about the Samsung Smart Remote that comes with THE FRAME TV, refer to "[About the Samsung Smart Remote \(THE FRAME\)](#)".
-  The Samsung Smart Remote may not be supported depending on the model or geographical area.

Using Smart Hub

Connect to Smart Hub for apps, games, movies, and more.

Enjoy the multiple functions provided by Smart Hub simultaneously on a single screen.



The image on your TV may differ from the image above depending on the model and geographical area.

When you press the button on your remote control, you can use the following functions and features.

1 Notification

You can view a list of notifications for all events that occur on your TV. A notification appears on the screen when it is time to broadcast a scheduled programme or when an event occurs on a registered device.

For more information, refer to "[Displaying the Home Screen](#)".

2 Settings

When the focus is moved to **Settings**, a list of quick settings icons appears above the top of the menu. You can quickly set frequently used functions by clicking the icons.

3 Source

You can select an external device connected to the TV.

For more information, refer to "[Switching between external devices connected to the TV](#)".

4 Search

You can search for channels, programmes, movie titles, and apps from Smart Hub.

 To use this feature, the TV must be connected to the Internet.

5 APPS



You can enjoy a wide range of content including news, sports, weather, and games by installing the corresponding apps on your TV.

 To use this feature, the TV must be connected to the Internet.

 For more information, refer to "[Using the APPS Service](#)".

6 Ambient Mode

You can enhance your living space with decorative content that matches the surroundings or view essential real-time information such as weather, time, and news on the TV screen when you are not watching TV.

To enter **Ambient Mode**, press the  button. To return to the TV mode, press the  button. To shut off the TV, press the  button.

If you press the  button when the TV is turned off, the TV turns on in **Ambient Mode**.

 If you use a remote control other than the Samsung Smart Remote, there may be restrictions to entering **Ambient Mode**.

 Because this function is specific to QLED and SERIF TVs, it may not be supported depending on the model.

 For more information about the **Ambient Mode**, refer to "[Using the Ambient Mode](#)".

7 Universal Guide

Universal Guide is an app that allows you to search for and enjoy various content such as TV shows, dramas, and movies in one place. **Universal Guide** can recommend content tailored to your preferences.

 For more information about **Universal Guide**, refer to "[Using the Universal Guide App](#)".

 Images may look blurry depending on the service provider's circumstances.

 This function may not be supported depending on the model or geographical area.

Art

When you are not watching TV or when the TV is turned off, you can use the Art mode function to edit image content such as artworks or photos or to display the content.

 This function is supported only in THE FRAME model.

 For more information, refer to the provided user manual.

Using the Ambient Mode

Learn about the functions available in Ambient Mode that are specific to the QLED and SERIF TVs.

> Ambient Mode

You can enhance your living space with decorative content that matches the surroundings or view essential real-time information such as weather, time, and news on the TV screen when you are not watching TV.

 Because this function is specific to QLED and SERIF TVs, it may not be supported depending on the model.

Entering Ambient Mode

To enter **Ambient Mode** from the TV viewing screen, press the  button, or select  >  **Ambient Mode**.



If you press the  button when the TV is turned off, the TV turns on in **Ambient Mode**.

 If you use a remote control other than the Samsung Smart Remote, there may be restrictions to entering **Ambient Mode**.

Ambient Mode browser screen



 The image on your TV may differ from the image above depending on the model and geographical area.

When you press the  or  button in **Ambient Mode**, the **Ambient Mode** browser screen appears at the bottom of the screen. In the **Ambient Mode** browser screen, you can select content and change the **Ambient Mode** settings.

1 Function and content preview

When you select a category at the bottom of the screen, a preview of available functions and content appears here. To view detailed information about a content item, move the focus to it, and then press the up directional button.

2 Ambient Settings

You can configure the following **Ambient Mode** settings:

- **Auto Brightness**

Changes the auto brightness setting for **Ambient Mode**.



When this function is set to **Off**, the brightness level of the TV screen is not automatically adjusted in response to the surrounding light level.

- **Sleep After**

Sets the time when the **Ambient Mode** screen turns off automatically.



If there is no remote control input for the set time, the screen goes off. To turn the screen back on in **Ambient Mode**, press the  button on the remote control.

- **Reset All Photos**

Resets the photos imported from your mobile device or Samsung Cloud.

3 TV

You can enter the TV viewing screen.

4 Selecting a content category

You can select your preferred content and background for the **Ambient Mode** screen.

 Available content categories may differ depending on the model or geographical area.

- **Special Edition**

Allows you to enjoy creative artwork and interior design content created by the world's finest artists and designers.

- **Décor**

Allows you to select content with a sensible and beautiful design.

- **My Album**

Allows you to set a photo stored in your mobile device or Samsung Cloud as the wallpaper of the **Ambient Mode** screen.

 To import photos from your mobile device or Samsung Cloud, use the SmartThings app on your mobile device.

 For more information about how to configure the photo settings, select **View Help**. This function is available after you select a photo in the **My Album** category.

- **Info**

Allows you to select essential real-time information such as weather, temperature, time, and news.

 This function may not be supported depending on the geographical area.

- **Artwork**

Allows you to select content such as world famous photos and artwork.

- **Background Theme**

Allows you to select a background theme provided by Samsung.

 Take a picture of a wall using the SmartThings app on your mobile device to create a custom background theme. When you use this function, there may be a delay in image transmission and optimisation depending on network conditions.

 You can set a background theme you created as a background of a content item. To set a background theme as the background of a content item, press the down directional button while watching the **Ambient Mode** screen.

5 About Ambient Mode

You can view information about **Ambient Mode**.

Applying effects to the content

When you are enjoying content in **Ambient Mode**, press the down directional button to change the following settings for the content:

 Available functions may not be supported depending on the content.

- **Backgrounds**

Changes the background of the content.

 This function may not be supported depending on the content.

 You can use the SmartThings app on your mobile device to take a picture of a wall and create a custom background. For more information, select the **How-To** icon. When you use this function, there may be a delay in image transmission and optimisation depending on network conditions.

- **Shadow Effects**

Applies a shadow effect that you select to the content.

 This function may not be supported depending on the content.

- **Brightness**

Adjusts the brightness of the content.

- **Saturation**

Adjusts the saturation of the content.

- **Colour Tone**

Adjusts the colours of the content.

- **Red Tone / Green Tone / Blue Tone**

Adjusts the red, green, blue contrast.

View detailed information about the content

When you are enjoying content in **Ambient Mode**, press the up directional button to view detailed information about the content.

Entering the TV viewing screen from Ambient Mode

To enter the TV viewing screen from **Ambient Mode**, press the  button, or select  **TV** in the **Ambient Mode** browser screen.

 If you press the  button when the TV is turned off, the TV viewing screen appears.

Using the Shortcuts

You can easily use the contents of Sources without running a series of commands.

To display the **Shortcuts** menu screen, press and hold the  button for 1 second or more.

To return to the TV mode, press the  button.

 Because this function is a QLED TV-specific function, it may not be supported depending on the model.

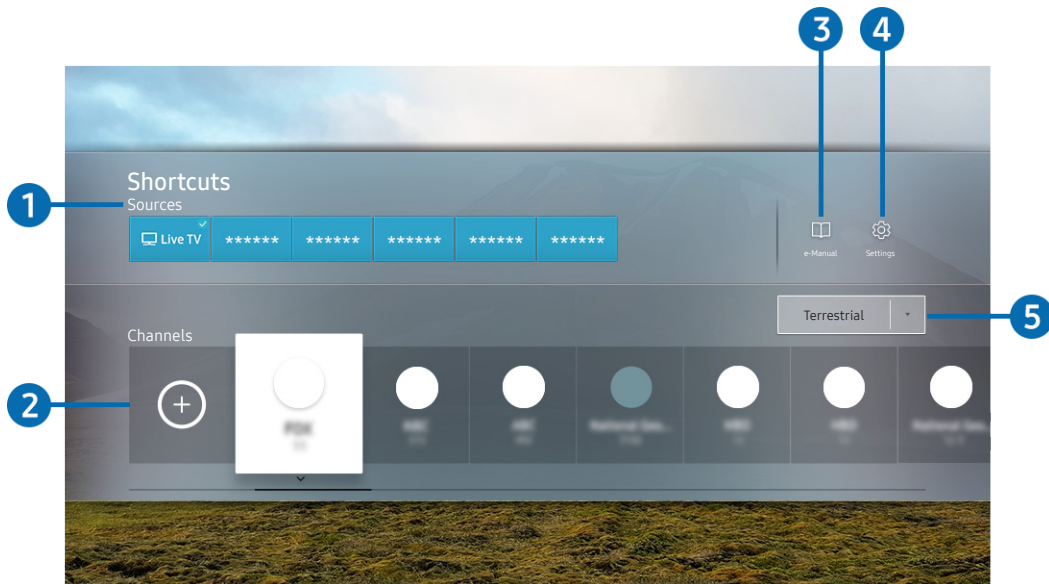

 The image on your TV may differ from the image above depending on the model and geographical area.

1 Sources

You can select an external device connected to the TV.

2 Channels

Press the  button to add a broadcast channel. You can move or remove added broadcast channels.

3 e-Manual

Displays the e-Manual guide.

4 Settings

Displays the main on-screen menu.

5 Terrestrial, Cable, Satellite, or Service Provider

Choose the broadcast type of the content: [Terrestrial](#), [Cable](#), [Satellite](#), or [Service Provider](#).

 This function may not be supported depending on the incoming broadcast signal.

Adding channels

1. Press . You can add only the channel that you are currently watching.
2. Move to the desired location.
3. Press the Select button.

The target channel is added in the bookmark ([Channels](#)) area.

Moving channels

1. Move the focus to the channel to move.
2. Press the down directional button.
3. Select [Move](#).
4. Move the selected channel to the desired location.
5. Press the Select button.

The selected channel is moved.





Removing a channels

1. Move the focus to the channels to remove.
2. Press the down directional button.
3. Select [Remove](#).



The selected channel is removed.

Using Bixby



Speak into the microphone on your Samsung Smart Remote to control your TV.

-  Bixby is available only when the TV is connected to the Internet.
-  To use Bixby, you must register and sign in to your Samsung account. Some functions may not be supported if you are not signed in to your Samsung account.
-  Bixby only supports some languages, and the supported functions may differ depending on the geographical area.
-  Bixby may not be supported depending on the model or geographical area.

Starting Bixby with voice

You can immediately start a conversation with Bixby by saying "Hi, Bixby." Say "Hi, Bixby," and the Bixby icon at the bottom of the TV screen is activated in Listen mode. Continue speaking. If Bixby does not respond to your voice, turn on the [Voice Wake-up](#) function, and then try again. ( > [Explore Now](#) >  [Settings](#) > [Voice Wake-up](#))

Starting Bixby using buttons on the Samsung Smart Remote

You can also have a conversation with Bixby using the Samsung Smart Remote buttons. Press and hold the  button on your Samsung Smart Remote, say a command, and then release the  button.

To view the Bixby guide, press the  button once:

- When you press the  button, the [Explore Now](#) button appears at the bottom of the screen. Press the Select button to go to the [Explore Bixby](#) screen.



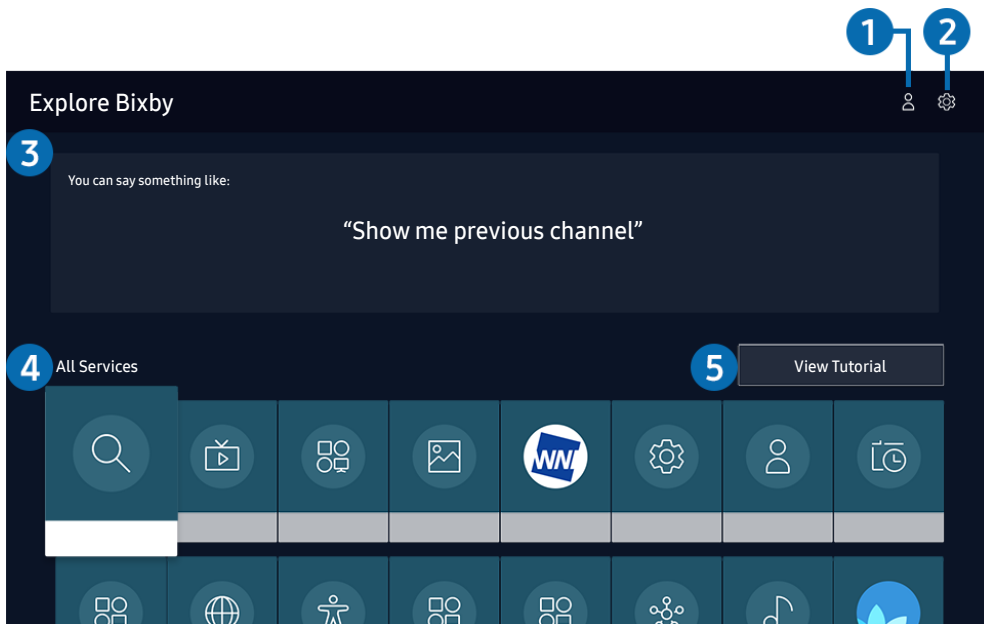

Learning about the Explore Bixby Screen



 The image on your TV may differ from the image above depending on the model and geographical area.

1 My Profile

Go to the [My Profile](#) screen to create a new account or register a voice ID. Sign in to your account with your voice, that is, your registered voice ID.

 If you are signed out of your Samsung account, select  [My Profile](#) to sign in.

2 Settings

You can change the settings for using Bixby.

 These functions may not be supported depending on the model or geographical area.

- [Language](#)

You can change Bixby's language.

 The languages of the TV and other apps will not change.

 Bixby only supports some languages.

- **Voice response**

You can change or turn off Bixby's voice.

 This function may not be supported depending on the language selected for Bixby.

- **Voice Wake-up**

You can configure this function to make Bixby respond to your voice.

 This function may not be supported depending on the model or geographical area.

- **Privacy**

You can permit or prohibit Bixby from utilising your personal information when you are using Bixby services.

3 Recommended commands

Displays recommended commands you can use to control the TV with Bixby given the current context.

4 All Services

You can learn the voice commands that let you use Bixby in various situations. Use the directional buttons to move to the desired command, and then press the Select button. You can operate the TV with various voice commands.

5 View Tutorial

The popup window on using Bixby appears.

Read Before Using Bixby

- The supported voice interaction languages and features may differ depending on the geographical area.
- If the language set differs from the language of your country, some features are not available.
- Bixby is available only when the TV is connected to the Internet.
- Even if the TV is connected to the Internet, there may be no response due to a Bixby server error.

- The existing functional specifications may be changed if Bixby is updated.
- Bixby is available only on TVs that support it and come with remote controls that have a microphone.
- Symbols including "-" and special characters are not supported. Consequently, if a word or sentence contains numeric values or symbols, the function may not operate properly.
- Searched results may not provide complete results.
- You may be required to pay for some apps. Consequently, you may encounter a service application or contract.
- To change the current channel by saying channel names as voice commands, you must finish [Set Up Your Service Provider](#). If [Set Up Your Service Provider](#) is not completed, you can complete it using [Reset](#) (🏠 > ⚙️ [Settings](#) > [General](#) > [Reset](#)). [Try Now](#)
- To use the voice text input function and the search function, you must consent to provisions allowing third parties to collect and use your voice data.
- To use the Bixby function, you must:
 - Agree to Smart Hub's Terms of Use
 - Agree to a guidance regarding the collection and use of personal information for the Smart Hub service.
 - Consent to the collection and use of personal information for the voice interaction-based service.

Provisions for using Bixby

- The voice interaction rate differs with the volume/tone, pronunciation, and ambient sound environment (TV sound and ambient noise).
- The optimal volume for voice commands is between 75 dB and 80 dB.

Updating the TV's Software

View your TV's software version and update it if necessary.

⚠ DO NOT turn off the TV's power until the update is complete. The TV will turn off and on automatically after completing the software update. Video and audio settings will be reset to their defaults after a software update.

 >  [Settings](#) > [Support](#) > [Software Update](#) 

Updating through the Internet

 >  [Settings](#) > [Support](#) > [Software Update](#) > [Update Now](#) 

 Updating from the Internet requires an active Internet connection.

Updating through a USB device

 >  [Settings](#) > [Support](#) > [Software Update](#) > [Update Now](#)

After downloading the update file from the Samsung website and storing it on a USB device, connect the USB device to the TV to update.

 To update using a USB device, download the update package from Samsung.com to your computer. Then, save the update package in the USB device's top-level folder. Otherwise, the TV will not be able to locate the update package.

Updating the TV automatically

 >  [Settings](#) > [Support](#) > [Software Update](#) > [Auto update](#) 

If the TV is connected to the Internet, you can have the TV update its software automatically while you are watching the TV. When the background update is completed, it is applied the next time the TV is turned on.

If you agree to the Smart Hub terms and conditions, [Auto update](#) is set to **On** automatically. If you want this function disabled, use the Select button to turn it off.

 This function may take a longer time if another network function is running concurrently.

 This function requires an Internet connection.

Getting Support

Get help directly from Samsung if you have a problem with your TV.

Getting support through Remote Management

 >  [Settings](#) > [Support](#) > [Remote Management](#) [Try Now](#)

After consenting to our service agreement, you can use [Remote Management](#) to access Remote Support and have a Samsung service technician diagnose your TV, correct problems, and update your TV's software remotely via the web. You can also turn [Remote Management](#) on and off.

 This function requires an Internet connection.



 You can also start this function by pressing and holding the  button for 5 or more seconds.

Finding the contact information for service

 >  [Settings](#) > [Support](#) > [About This TV](#) [Try Now](#)

You can view the address of the Samsung website, the call centre phone number, your TV's model number, your TV's software version, Open Source Licence and other information you may need to get service support from a Samsung call agent or the Samsung website.

 You can also view information by scanning the QR code of your TV.

 You can also start this function by pressing and holding the  button for 5 or more seconds. For the standard remote control, press and hold the  (Play) button for 5 or more seconds. Continue holding the button until the customer information pop-up window appears.

Requesting service

 >  [Settings](#) > [Support](#) > [Request Support](#) [Try Now](#)

You can request service when you encounter a problem with the TV. Select the item matching the problem that you encountered, move the focus to [Next](#), and then press the Select button. Select [Request Now](#) or [Schedule Appointment](#) > [Request](#) > [Send](#). Your service request will be registered. The Samsung Contact Centre will contact you to set up or confirm your service appointment.

 This function may not be supported depending on the geographical area.

 You must agree to the terms and conditions for the service request.

 This function requires an Internet connection.

Connections

You can watch live broadcasts by connecting an antenna and antenna cable to your TV and can get access to the Internet by using a LAN cable or wireless access point. Using various connectors, you can also connect external devices.

Connection Guide

You can view detailed information about external devices that can be connected to the TV.

 >  [Source](#) > [Connection Guide](#) Try Now

It guides you the way to connect various external devices such as the video devices, game console, and PC through pictures. If you select the connection method to an external device, the information details appear.

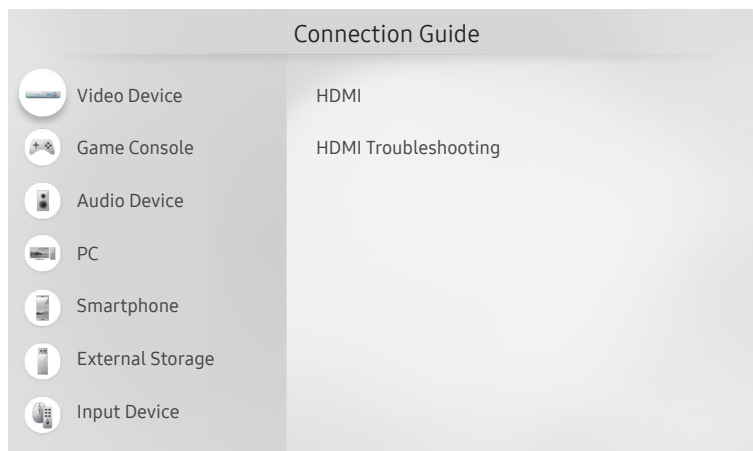

 The image on your TV may differ from the image above depending on the model and geographical area.



Connecting an Antenna (Aerial)

You can connect an antenna cable to your TV.

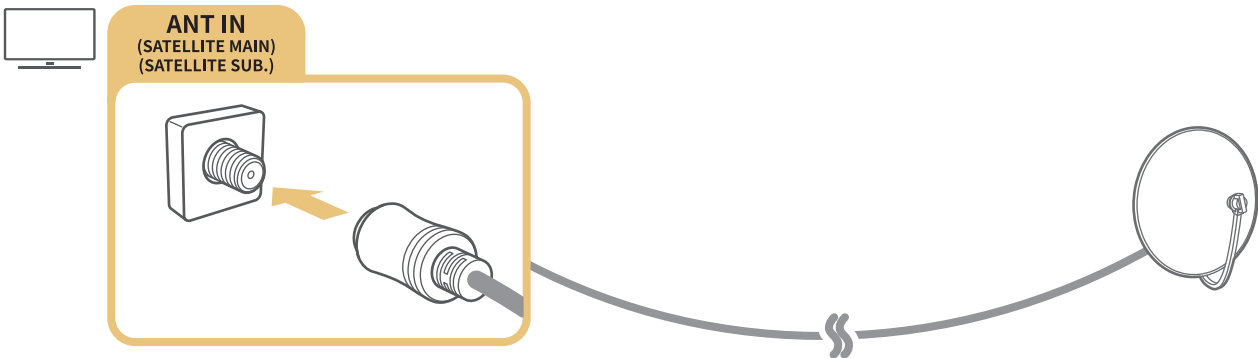
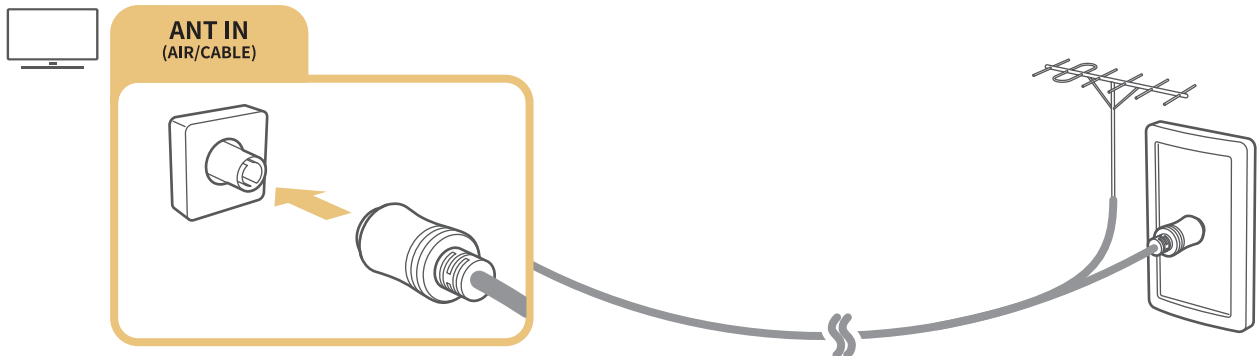
 An antenna connection is not necessary if you connect a cable box or satellite box.



It is best to connect the both connectors using a Multi-Switch or DiSEqC Switch, etc and to set **Aerial Connection Type** to **Dual**.

-  A connection method may differ with the models.
-  The DVB-T2 system may not be supported depending on the geographical area.
-  Depending on the model or geographical area.

Connecting to the Internet

You can get access to the Internet through your TV.

 >  **Settings** > **General** > **Network** > **Open Network Settings** Try Now





Configure network settings to connect to an available network.

Establishing a wired Internet connection

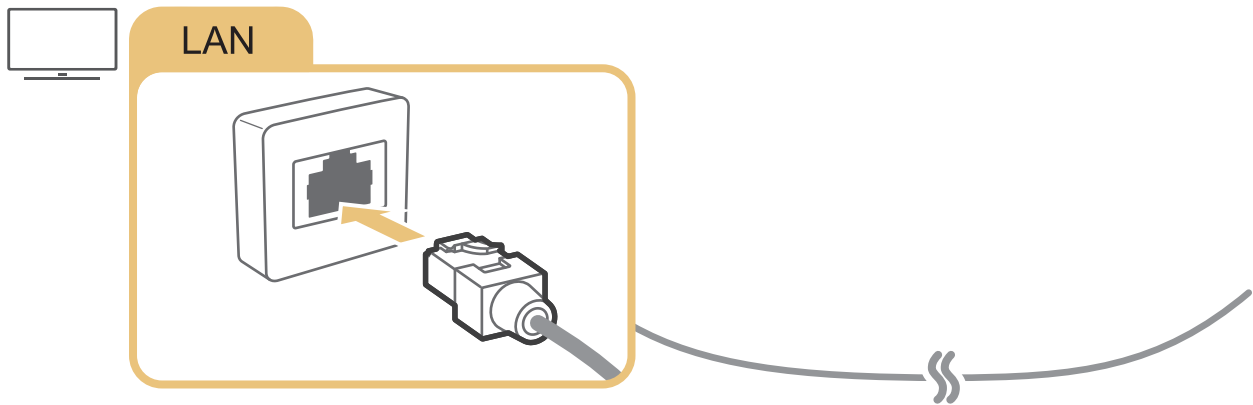
 >  **Settings** > **General** > **Network** > **Open Network Settings** > **Wired**

If you connect a LAN cable, the TV automatically accesses the Internet.







-  If the TV does not automatically connect to the network, refer to "Network Issues" in "Troubleshooting".
-  Use a CAT7 (*STP type) cable for the connection.
* Shielded Twisted Pair
-  The TV will not be able to connect to the Internet if your network speed is below 10 Mbps.
-  This function may not be supported depending on the model.

Establishing a wireless Internet connection

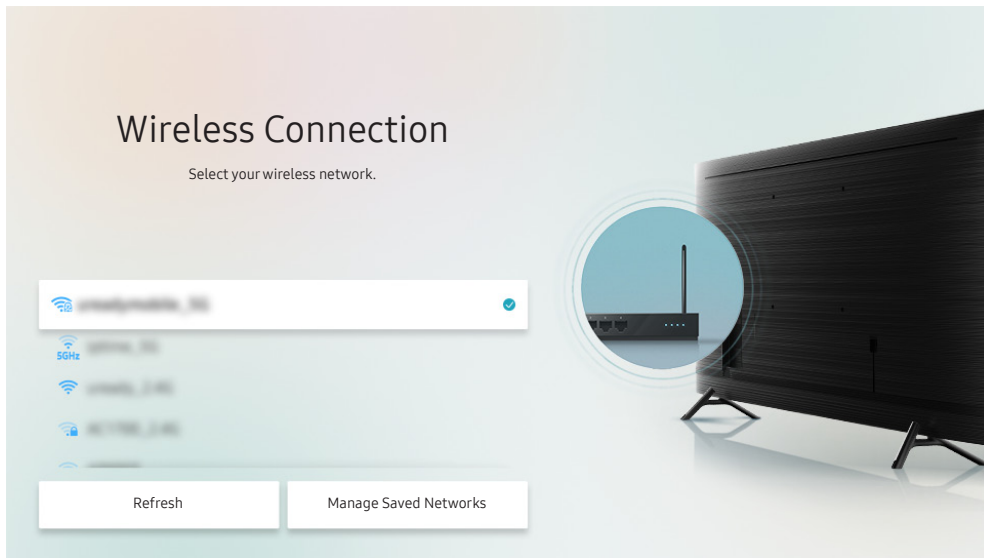
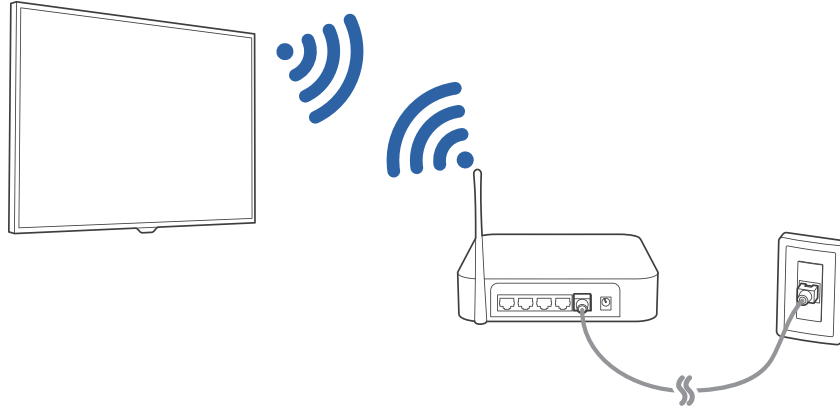
 >  **Settings** > **General** > **Network** > **Open Network Settings** > **Wireless**

Make sure that you have the wireless access point's SSID (name) and password settings before attempting to connect. The network name (SSID) and security key are available on the wireless access point's configuration screen. See the wireless access point's user manual for more information.



-  The image on your TV may differ from the image above depending on the model and geographical area.
-  If no wireless access point is found, select **Add Network** at the bottom of the list and enter the network name (SSID).
-  If your wireless access point has a WPS or PBC button, select **Use WPS** at the bottom of the list, and then push the WPS or PBC button on your access point within 2 minutes. The TV will connect automatically.
-  To view or delete previously connected network names (SSIDs), move the focus to **Manage Saved Networks**, and then press the Select button.

Checking the Internet connection status

 >  [Settings](#) > [General](#) > [Network](#) > [Network Status](#) 

View the current network and Internet status.

Resetting Your Network

 >  [Settings](#) > [General](#) > [Network](#) > [Reset Network](#) 

Restore the network settings to the factory default.

Turning on the TV with a mobile device

 >  [Settings](#) > [General](#) > [Network](#) > [Expert Settings](#) > [Power On with Mobile](#)

You can turn on the TV with your mobile device when both of them are connected to the same network.

 This function is available with a mobile device connected to the TV through the SmartThings app or the AirPlay function.

Connecting an IP control device to the TV

 >  [Settings](#) > [General](#) > [Network](#) > [Expert Settings](#) > [IP Remote](#)

You can connect an IP control device to the TV remotely to manage your IP device.

 To use this function, [Power On with Mobile](#) must be turned on.

 Turning this feature on may allow other IP control devices to control your TV. We recommend turning this feature on only if an authorised third-party custom controller is installed and configured specifically for a Samsung TV and if your Wi-Fi network is password protected.

 This function may not be supported depending on the model or geographical area.

Changing the name of the TV on a network



 >  [Settings](#) > [General](#) > [System Manager](#) > [Device Name](#) 

You can change the name of the TV on the network. Select [User Input](#) at the bottom of the list and change the name.

Connection Cables for External Devices

You can view detailed information about the connection cables for external devices that can be connected to the TV.

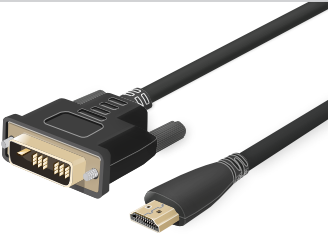
Cable name	Image	Description
HDMI to HDMI		<p>Each cable simultaneously transmits digital video and audio signals from an external device to the HDMI port on the TV.</p> <p>Cables are divided into various types according to the types of input/output ports on external devices.</p>
HDMI to MINI HDMI		
HDMI to Micro HDMI		
HDMI to USB Type-C		
HDMI to DisplayPort		
Mini DisplayPort to HDMI		

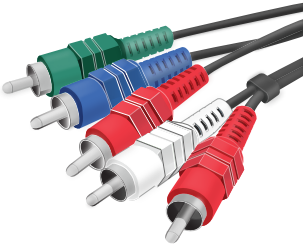
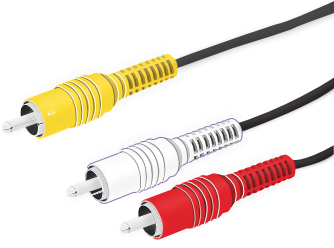
Cable name	Image	Description
DVI to HDMI		<p>DVI to HDMI cables can transmit only digital video signals and not audio signals. We recommend that you use HDMI to HDMI cables.</p>
Optical		<p>Optical cables are used to transmit audio signals to external speakers with low signal loss. Optical cables do not transmit video signals.</p>
Component		<p>Component cables transmit analogue signals. The video signal is separated and transmitted to the red, green, and blue terminals to provide HD (1080i) pictures. The audio signal is transmitted to the red and white terminals.</p>
Composite		<p>Composite cables transmit analogue signals. The video signal is transmitted to the yellow terminal, and the audio signal is transmitted to the red and white terminals.</p>





 Available connection cables may differ depending on the model or geographical area.

Switching between external devices connected to the TV

You can switch between TV programmes and the content of external devices.

> Source

When you select a connected external device on the **Source** screen, the output of the selected device is displayed on the TV's screen.

-  On the standard remote control, press the SOURCE button.
-  To control a device (Blu-ray player, game console, etc.) that supports universal remote control with the TV's remote control, connect the device to an HDMI port on the TV, and then turn on the device. The output displayed on the TV is automatically switched to the output of the device or you can configure universal remote control for the device automatically. For more information, refer to "Controlling External Devices with a Samsung Remote Control - Using the Universal Remote".
-  When a USB device is connected to the USB port, a pop-up message appears that lets you switch easily to the media content listed on the device.
-  This function may not be supported depending on the device and geographical area.

Editing the name and icon of an external device

> Source

You can change the port name for a connected external device or add it to Home Screen.

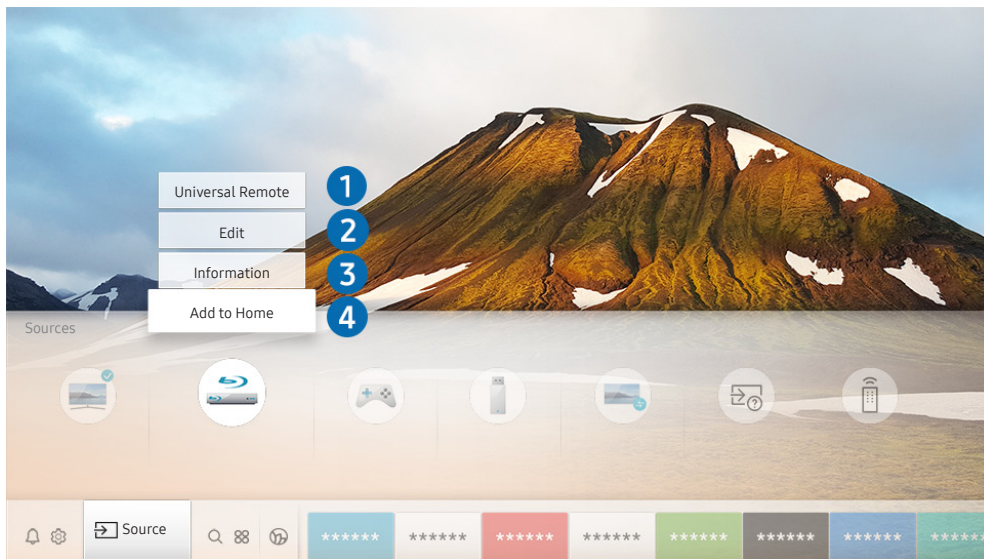

-  The image on your TV may differ from the image above depending on the model and geographical area.

1. Move the focus to a connected external device.
2. Press the Up directional button. The following functions become available.

 Available functions may differ depending on the port type.

1 Universal Remote

You can control external devices connected to the TV using a Samsung remote control. To control external devices, register them by following the instructions on the screen.

 This function may not be supported depending on the model or geographical area.

 For more information, refer to "[Controlling External Devices with a Samsung Remote Control - Using the Universal Remote](#)".

2 Edit

You can rename the input ports and change the device icons.

3 Information

You can view the detailed information about the external devices connected to the TV.

4 Add to Home

You can add the port of an external device to the Home Screen for quick switching.

Using additional functions

You can use the following features on the **Source** screen.

- **Remote Access**

Use the TV to access your PC via remote PC or Screen Sharing (Wireless).

 For more information, refer to "[Using the Remote Access](#)".

- **Connection Guide**

The guide to device connections.

- **Universal Remote**



Lets you register external devices to your Samsung remote control and control them using the Remote.

 This function may not be supported depending on the model or geographical area.

 For more information, refer to "[Controlling External Devices with a Samsung Remote Control - Using the Universal Remote](#)".

Connection Notes

When connecting an external device, note the following.

-  The number of connectors and their names and locations may differ with the model.
-  Refer to the external device's operating manual when connecting it to the TV. The number of external device connectors and their names and locations may differ with the manufacturer.

Connection notes for HDMI

- The following types of HDMI cables are recommended:
 - High Speed HDMI Cable
 - High Speed HDMI Cable with Ethernet
 - Premium High Speed HDMI Cable
 - Premium High Speed HDMI Cable with Ethernet
 - Ultra High Speed HDMI Cable
 - Use an HDMI cable with a thickness of 0.66 inches (17 mm) or less.
 - Using a non-certified HDMI cable may result in a blank screen or a connection error.
 - Some HDMI cables and devices may not be compatible with the TV due to different HDMI specifications.
 - This TV does not support HDMI Ethernet Channel. Ethernet is a Local Area Network (LAN) built with coaxial cables standardised by the IEEE.
 - Use a cable shorter than 10 feet (3 m) to get the best UHD contents viewing quality.
 - Many computer graphics adaptors do not have HDMI ports, but have DVI or DisplayPort ports instead. If your PC does not support HDMI video out, connect your PC with a DVI to HDMI or HDMI to DisplayPort cable.
 - When the TV is connected to an external device such as a DVD/BD player or a set-top box via HDMI, power sync mode will be automatically activated. In the power sync mode, the TV continues to detect and connect external devices via HDMI cable. This function can be deactivated by removing the HDMI cable of the connected device.
-  This function may not be supported depending on the model.

Connection notes for audio devices

- For better audio quality, it is a good idea to use an AV receiver.
- If you connect an external audio device using an optical cable, the **Sound Output** setting is automatically changed to the connected device. However, to make this happen, you must turn on the external audio device before connecting the optical cable. To manually change the **Sound Output** setting, do one of the following:
 - Use the **Quick Settings** screen to change to the connected device:
Use the Select button to select **Optical** on the **Sound Output** menu. (🏠 > ⚙️ **Settings** > up directional button > **Sound Output**).
 - Use the **Settings** screen to change to the connected device:
Select **Optical** on the **Sound Output** menu. (🏠 > ⚙️ **Settings** > **Sound** > **Sound Output**).
- An unusual noise coming from a connected audio device while you are using it may indicate a problem with the audio device itself. If this occurs, ask for assistance from the audio device's manufacturer.
- Digital audio is only available with 5.1 channel broadcasts.

Connection notes for computers

- For the resolutions supported by the TV, refer to "Read Before Connecting a Computer (Supported Resolutions)".
- If you want to connect your PC and TV wirelessly, both of them must be connected to each other on the same network.
- When sharing content with other network-based devices such as those in an IP (Internet Protocol) storage system, sharing may not be supported due to the network's configuration, quality, or functionality, for example, if the network has an NAS (Network-Attached Storage) device.

Connection notes for mobile devices

- To use the Smart View function, the mobile device must support a mirroring function such as Screen Mirroring or Smart View. To check whether your mobile device supports the mirroring function, refer to the mobile device's user manual.
- To use Wi-Fi Direct, the mobile device must support the Wi-Fi Direct function. To check whether your mobile device supports Wi-Fi Direct function, refer to the mobile device's user manual.
- The mobile device and your Smart TV must be connected to each other on the same network.
- The video or audio may stop intermittently, depending on network conditions.
- When sharing content with other network-based devices such as those in an IP (Internet Protocol) storage system, sharing may not be supported due to the network's configuration, quality, or functionality, for example, if the network has an NAS (Network-Attached Storage) device.

Remote Control and Peripherals









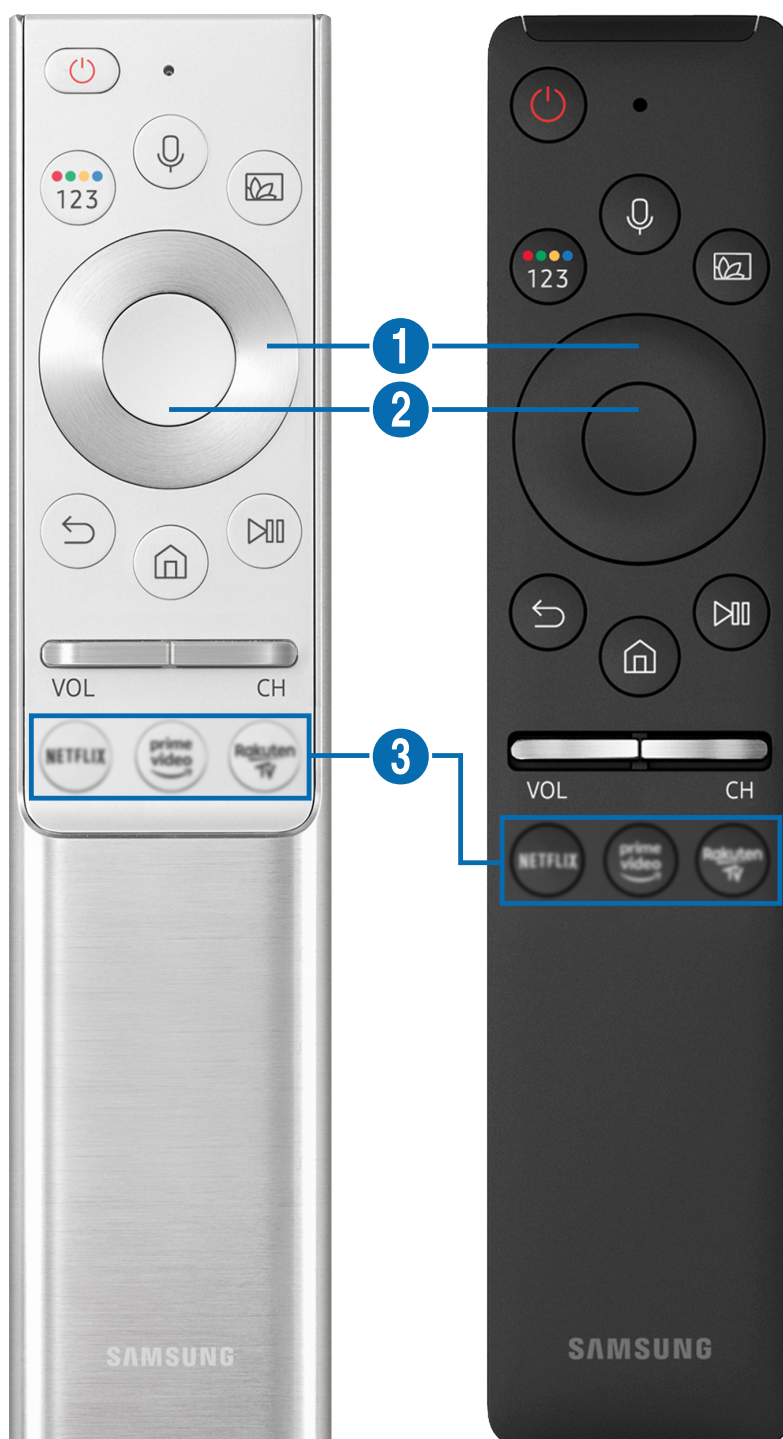

You can control TV operations with your Samsung Smart Remote. Pair external devices such as a keyboard for ease of use.





About the Samsung Smart Remote (QLED and SERIF TVs)





Learn about the buttons on the Samsung Smart Remote that comes with the QLED and SERIF TVs.

 The images, buttons, and functions of the Samsung Smart Remote may differ with the model or geographical area.



Button	Description
 (Bixby)	<p>Runs Bixby. Press and hold the button, say a command, and then release the button to run Bixby.</p> <p>When you press the button, the Explore Now menu appears at the bottom of the screen. To move to the Explore Bixby screen, press the Select button.</p> <p> The supported Bixby's languages and features may differ by geographical region.</p>
 (Colour / Number button)	<p>Each time you press this button, the coloured buttons window and the virtual numeric pad are displayed alternately.</p> <ul style="list-style-type: none"> • Use these coloured buttons to access additional options specific to the feature you are using. • Press to bring up the virtual numeric pad on the screen. Use the numeric keypad to enter numeric values. Select numbers and then select Done to enter a numeric value. Use to change the channel, enter a PIN, enter a ZIP code, etc. <p> When pressed for 1 second or more for a channel that supports the teletext service, the TTX menu appears on the TV screen. For more information, refer to "Teletext Feature".</p> <p> If the Colour Button appears with a number strip on the screen, select the Colour Button and then select a specific colour by using the directional pad (up/down/left/right). Use this to access additional options that are specific to the feature in use.</p>
 (Ambient Mode)	<p>In TV mode, press the button to enter Ambient Mode.</p> <p>If you press the button when the TV is turned off, the TV turns on in Ambient Mode.</p> <p> When pressed for 1 second or more, the Shortcuts menu screen appears.</p> <p> This function may not be supported depending on the model or geographical area.</p>
 Directional pad (up/down/left/right)	<p>Moves the focus.</p>
 Select	<p>Selects or runs a focused item. When pressed while you are watching a broadcast programme, detailed programme information appears.</p>

Button	Description
 (Return)	Press to return to the previous menu. When pressed for 1 second or more, the running function is terminated. When pressed while you are watching a programme, the previous channel appears.
 (Smart Hub)	Press to return to the Home Screen.
 (Play/pause)	When pressed, the playback controls appear. Using these controls, you can control the media content that is playing.
VOL (Volume)	Point the Samsung Smart Remote at the remote control sensor of the TV, and then move the button up or down to adjust the volume on the TV. To mute the sound, press the button. When pressed for 1 second or more, the Accessibility Shortcuts appears.
CH (Channel)	Move the button up or down to change the channel. To see the Guide screen, press the button. When pressed for 1 second or more, the Channel List screen appears. Press and hold the button up or down to quickly change the channel.
 (Launch app button)	Launch the app indicated by the button.







-  Use the Samsung Smart Remote less than 6 m from the TV. The usable distance may vary with the wireless environmental conditions.
-  [The images, buttons, and functions of the Samsung Smart Remote may differ with the model or geographical area.](#)
-  To use the Samsung Smart Remote to control a compatible external device that does not support HDMI-CEC (Anynet+), you must configure universal remote control for the device. For more information, refer to "[Controlling External Devices with a Samsung Remote Control - Using the Universal Remote](#)".
-  To use the Samsung Smart Remote to control a compatible external device that does support HDMI-CEC (Anynet+), connect the device to an HDMI port on the TV using an HDMI cable. For more information, refer to "[Using Anynet+ \(HDMI-CEC\)](#)".
-  This function may not be supported depending on the model or geographical area.

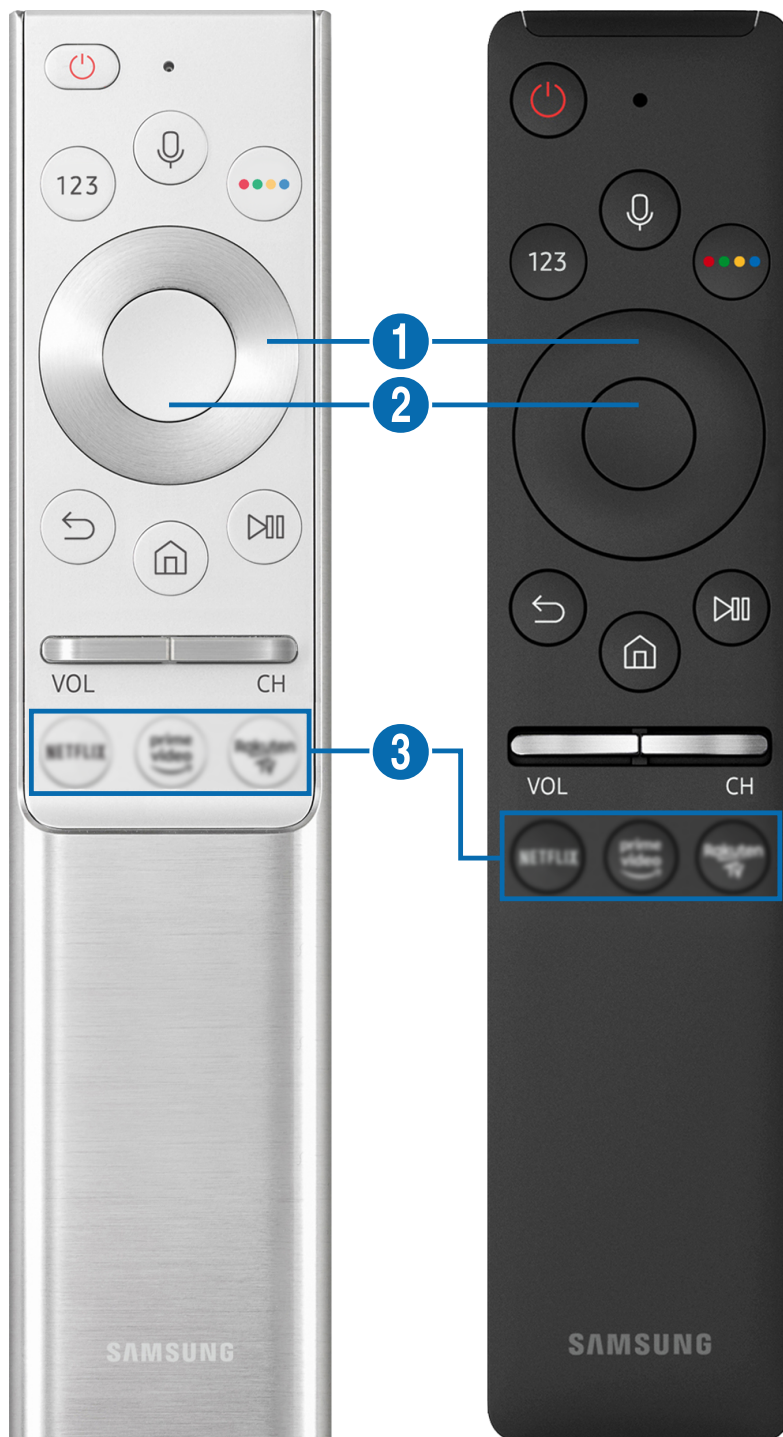



About the Samsung Smart Remote (UHD TV)





Learn about the buttons on the Samsung Smart Remote that comes with the UHD TV.

 The images, buttons, and functions of the Samsung Smart Remote may differ with the model or geographical area.



Button	Description
 (Bixby)	<p>Runs Bixby. Press and hold the button, say a command, and then release the button to run Bixby.</p> <p>When you press the button, the Explore Now menu appears at the bottom of the screen. To move to the Explore Bixby screen, press the Select button.</p> <p> The supported Bixby's languages and features may differ by geographical region.</p>
 (Number button)	<p>When pressed, the virtual numeric pad appears on the screen so that you can enter a numeric value using it.</p> <p>Select numbers and then select Done to enter a numeric value. Use to change the channel, enter a PIN, enter a ZIP code, etc.</p> <p> When pressed for 1 second or more for a channel that supports the teletext service, the TTX menu appears on the TV screen. For more information, refer to "Teletext Feature".</p>
 (Colour button)	<p>When pressed, coloured buttons appear on the screen. Use these coloured buttons to access additional options specific to the feature you are using.</p>
 1 Directional pad (up/down/left/right)	<p>Moves the focus.</p>
 2 Select	<p>Selects or runs a focused item. When pressed while you are watching a broadcast programme, detailed programme information appears.</p>









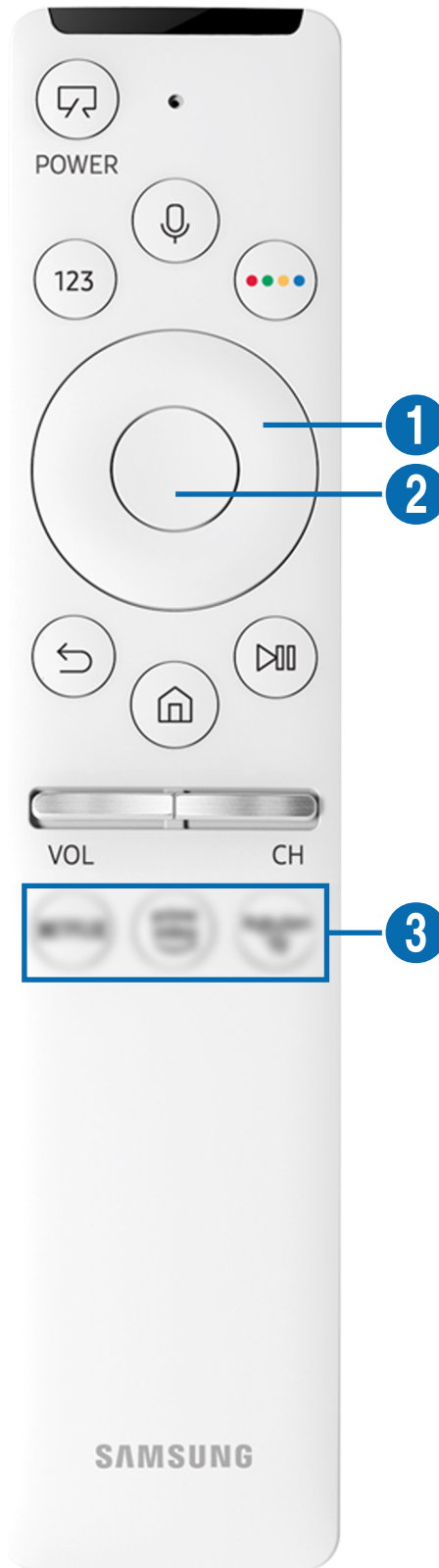

Button	Description
 (Return)	Press to return to the previous menu. When pressed for 1 second or more, the running function is terminated. When pressed while you are watching a programme, the previous channel appears.
 (Smart Hub)	Press to return to the Home Screen.
 (Play/pause)	When pressed, the playback controls appear. Using these controls, you can control the media content that is playing.
VOL (Volume)	Move the button up or down to adjust the volume. To mute the sound, press the button. When pressed for 1 second or more, the Accessibility Shortcuts appears.
CH (Channel)	Move the button up or down to change the channel. To see the Guide screen, press the button. When pressed for 1 second or more, the Channel List screen appears. Press and hold the button up or down to quickly change the channel.
 (Launch app button)	Launch the app indicated by the button.





-  Use the Samsung Smart Remote less than 6 m from the TV. The usable distance may vary with the wireless environmental conditions.
-  [The images, buttons, and functions of the Samsung Smart Remote may differ with the model or geographical area.](#)
-  To use the Samsung Smart Remote to control a compatible external device that does not support HDMI-CEC (Anynet+), you must configure universal remote control for the device. For more information, refer to "[Controlling External Devices with a Samsung Remote Control - Using the Universal Remote](#)".
-  To use the Samsung Smart Remote to control a compatible external device that does support HDMI-CEC (Anynet+), connect the device to an HDMI port on the TV using an HDMI cable. For more information, refer to "[Using Anynet+ \(HDMI-CEC\)](#)".
-  This function may not be supported depending on the model or geographical area.





About the Samsung Smart Remote (THE FRAME)

Learn about the buttons on the Samsung Smart Remote that comes with the THE FRAME TV.





Button	Description
 (POWER)	<p>When watching TV, press to switch to Art mode. In Art mode, press to switch to watching TV. Press and hold to turn off the TV completely.</p> <p> When the TV turns off and on again, display the last used mode.</p>
 (Bixby)	<p>Runs Bixby. Press and hold the button, say a command, and then release the button to run Bixby.</p> <p>When you press the button, the Explore Now menu appears at the bottom of the screen. To move to the Explore Bixby screen, press the Select button.</p> <p> The supported Bixby's languages and features may differ by geographical region.</p>
 (Number button)	<p>When pressed, the virtual numeric pad appears on the screen so that you can enter a numeric value using it.</p> <p>Select numbers and then select Done to enter a numeric value. Use to change the channel, enter a PIN, enter a ZIP code, etc.</p> <p> When pressed for 1 second or more for a channel that supports the teletext service, the TTX menu appears on the TV screen. For more information, refer to "Teletext Feature".</p>
 (Colour button)	<p>When pressed, coloured buttons appear on the screen. Use these coloured buttons to access additional options specific to the feature you are using.</p> <p> To immediately set Colour & Brightness while enjoying Art mode, press the button.</p>
 Directional pad (up/down/left/right)	<p>Moves the focus.</p>
 Select	<p>Selects or runs a focused item. When pressed while you are watching a broadcast programme, detailed programme information appears.</p>

Button	Description
 (Return)	Press to return to the previous menu. When pressed for 1 second or more, the running function is terminated. When pressed while you are watching a programme, the previous channel appears.
 (Smart Hub)	Press to return to the Home Screen.
 (Play/pause)	When pressed, the playback controls appear. Using these controls, you can control the media content that is playing.
VOL (Volume)	Move the button up or down to adjust the volume. To mute the sound, press the button. When pressed for 1 second or more, the Accessibility Shortcuts appears.
CH (Channel)	Move the button up or down to change the channel. To see the Guide screen, press the button. When pressed for 1 second or more, the Channel List screen appears. Press and hold the button up or down to quickly change the channel.
 (Launch app button)	Launch the app indicated by the button.

-  Use the Samsung Smart Remote less than 6 m from the TV. The usable distance may vary with the wireless environmental conditions.
-  [The images, buttons, and functions of the Samsung Smart Remote may differ with the model or geographical area.](#)
-  To use the Samsung Smart Remote to control a compatible external device that does not support HDMI-CEC (Anynet+), you must configure universal remote control for the device. For more information, refer to "[Controlling External Devices with a Samsung Remote Control - Using the Universal Remote](#)".
-  To use the Samsung Smart Remote to control a compatible external device that does support HDMI-CEC (Anynet+), connect the device to an HDMI port on the TV using an HDMI cable. For more information, refer to "[Using Anynet+ \(HDMI-CEC\)](#)".
-  This function may not be supported depending on the model or geographical area.

Connecting the Samsung Smart Remote to the TV

Connect the Samsung Smart Remote to your TV to operate the TV.

When you turn on the TV for the first time, the Samsung Smart Remote pairs to the TV automatically. If the Samsung Smart Remote does not pair to the TV automatically, point it at the front of the TV, and then press and hold the  and  buttons simultaneously for 3 seconds or more.

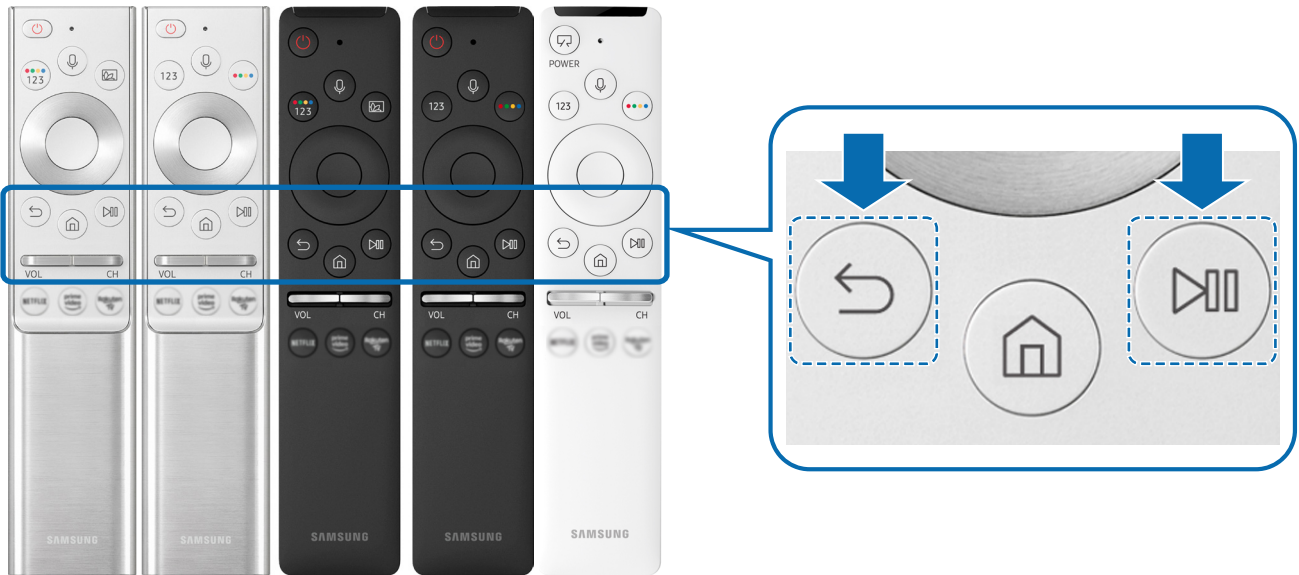

 The images, buttons, and functions of the Samsung Smart Remote may differ with the model or geographical area.







 The Samsung Smart Remote may not be supported depending on the model or geographical area.

Controlling External Devices with a Samsung Remote Control - Using the Universal Remote

Control the TV and connected external devices with a Samsung remote control.

 >  [Source](#) > [Universal Remote](#)

You can control external devices connected to the TV using a Samsung remote control. To control external devices, register them by following the instructions on the screen.

-  This function may not be supported depending on the model or geographical area.
-  You can also use the [Anynet+ \(HDMI-CEC\)](#) function to operate external Samsung devices with your TV's remote control without any additional setup.
-  Certain external devices connected to the TV may not support the universal remote feature.
-  Do not place any obstacles in front of an external device and TV's logo. It may cause signals from the remote control to be transmitted improperly.
-  The TV memorises both the external device and its connection port (HDMI 1, HDMI 2, etc.).
-  If you have difficulty controlling external devices with the Universal Remote, try adjusting the positions of the external devices.
-  This function may not operate properly depending on the TV installation environment and the features of external devices.

Using Anynet+ (HDMI-CEC)

Control an external device connected via Anynet+ (HDMI-CEC) with the remote control.

You can use the TV's remote control to control external devices that are connected to the TV by an HDMI cable and that support Anynet+ (HDMI-CEC). Note that you can only set up and operate Anynet+ (HDMI-CEC) with the remote control.

Connecting an external device through Anynet+ and using their menus

 >  **Settings** > **General** > **External Device Manager** > **Anynet+ (HDMI-CEC)** 

1. Set **Anynet+ (HDMI-CEC)** to **On**.
2. Connect an HDMI-CEC-compliant device to the TV.
3. Turn on the connected external device.

The device is automatically connected to the TV. After connection is finished, you can access the menu of the connected device on your TV screen using your TV remote and control the device.

 The connecting process can take up to 2 minutes to complete.





Read before connecting an Anynet+ (HDMI-CEC) device

 Anynet+ (HDMI-CEC)-enabled devices must be connected to the TV with an HDMI cable. Note that some HDMI cables may not support Anynet+ (HDMI-CEC).

 You can configure the TV's Universal Remote to control third-party cable boxes, Blu-ray players, and home theatres that do not support HDMI-CEC. For more information, refer to "[Controlling External Devices with a Samsung Remote Control - Using the Universal Remote](#)".

 Anynet+ cannot be used to control external devices that do not support HDMI-CEC.

 The TV remote control may not work under certain circumstances. If this occurs, set up the device as an Anynet+ (HDMI-CEC)-enabled device again.

-  Anynet+ (HDMI-CEC) works only with external devices that support HDMI-CEC and only when those devices are either in standby mode or turned on.
-  Anynet+ (HDMI-CEC) can control up to 12 compliant external devices (up to 3 of the same type) except for home theatres. Anynet+ (HDMI-CEC) can control only one home theatre system.
-  To listen to 5.1 channel audio from an external device, connect the device to the TV via an HDMI cable and connect a 5.1 home theatre system directly to the external device's digital audio output connector.
-  If an external device has been set up for both Anynet+ and a universal remote control, the device can be controlled only with the universal remote control.

Controlling the TV with a Keyboard, Mouse, or Gamepad





Connecting a keyboard, mouse or gamepad to make it easier to control the TV.

 >  [Settings](#) > [General](#) > [External Device Manager](#) > [Input Device Manager](#) Try Now

You can connect a keyboard, mouse or gamepad to make it easier to control the TV.





Connecting a USB keyboard, Mouse, or gamepad

Plug the keyboard, mouse or gamepad cable into the USB port.





-  If you connect a mouse, it is available only in the [Internet](#) app and [Remote Access](#) function.
-  XInput USB gamepads are supported.
-  For more information, refer to [Input Device](#) in [Connection Guide](#) ( >  [Source](#) > [Connection Guide](#) > [Input Device](#)).

Connecting a Bluetooth keyboard, Mouse, or gamepad

 >  [Settings](#) > [General](#) > [External Device Manager](#) > [Input Device Manager](#) > [Bluetooth Device List](#)

-  This function may not be supported depending on the model or geographical area.
-  If your device was not detected, position the keyboard close to the TV, and then select [Refresh](#). The TV scans for available devices again.
-  If you connect a mouse, it is available only in the [Internet](#) app.
-  For more information about how to connect a Bluetooth device, refer to the Bluetooth device's user manual.

Using the keyboard and mouse

Button	Description
Directional keys	Moves the focus
Windows key	Displays the TV settings
Enter key	Selects or runs a focused item
ESC key	Returns to the previous screen
F1 / F2 / F3 / F4 key	Colour buttons —  /  /  / 
F5 key	Displays the Home Screen
F6 key	Displays the Source screen
F7 key	Displays the Channel List
F8 key	Mutes the sound
F9 / F10 key	Adjusts the volume
F11 / F12 key	Changes the channel
Page Up / Page Down	Scrolls a web page displayed on the Internet app.
Left-click	Available only in the Internet app. You can click a menu or link to start a function as you do on a PC.
Right-click	Available only in the Internet app. You can use the following functions:  The options displayed on the menu may differ depending on the selected item. <ul style="list-style-type: none">• Open• Open Link in New Tab• Enable Scroll Mode

 The key operations may differ on some apps.

Setting up the input devices

 >  **Settings** > **General** > **External Device Manager** > **Input Device Manager**

- **Keyboard Settings**

You can set up the keyboard with the **Keyboard Language** and **Keyboard type** functions.

- **Mouse Settings**

You can set up the mouse with the **Primary Button** and **Pointer Speed** functions.

Entering Text using the On-Screen Virtual Keyboard

Use the Virtual keyboard to enter text on your TV.

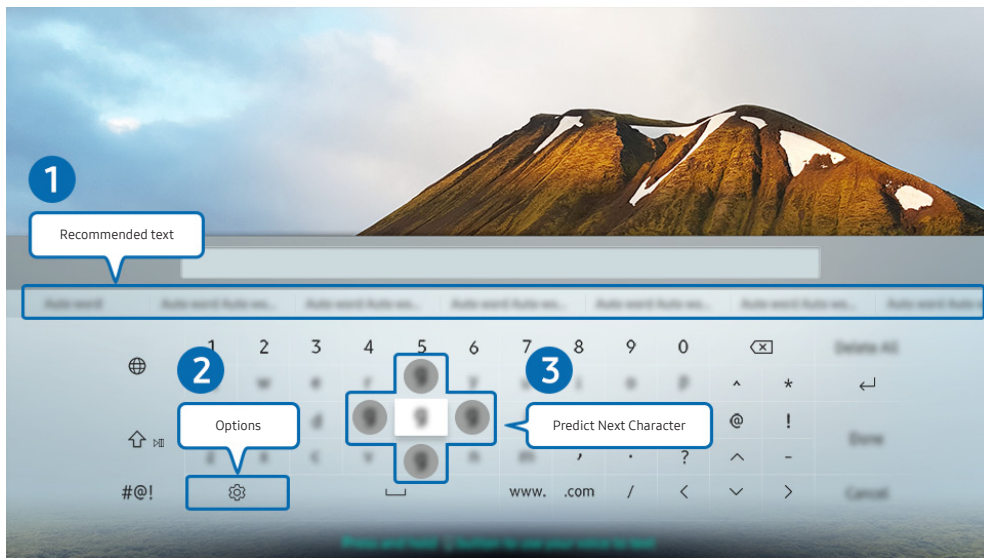

 The image on your TV may differ from the image above depending on the model and geographical area.

1 Recommended text

When you type a word you want to search for, this function shows related suggestions from which you can choose one.

2 Options

Select  on the Virtual keyboard screen. The following options are available:

 The options available may differ depending on the function running currently.

- [Recommended text](#)
- [Reset Recommended Text Memory](#)
- [Predict Next Character \(when using direction buttons\)](#)
- [Language](#)

3 Predict Next Character

Each time you type a character on the Virtual keyboard, the next characters predicted to be typed are displayed, and you can use the directional buttons on the remote control to select one from them.

Entering Text using the remote control's microphone and the on-screen Virtual keyboard

When the Virtual keyboard is on the screen, press and hold the  button on the Samsung Smart Remote, speak into the microphone on the Samsung Smart Remote, and then release the button. What you say appears on the screen as text.

 Entering text with your voice may not be supported for some functions.

 This function may not be supported depending on the model or geographical area.











Smart Features

You can enjoy various apps with Smart Hub.

Using Smart Hub

View descriptions of Smart Hub's basic functions.

From Smart Hub, you can use the Internet search function, install and use various apps, view photos and videos or listen to music stored on external storage devices, and perform more functions.

-  Some of the Smart Hub services are paid services.
-  To use Smart Hub, the TV must be connected to the Internet.
-  Some Smart Hub features may not be supported depending on the service provider, language, or geographical area.
-  Smart Hub service outages can be caused by disruptions in your Internet service.
-  To use Smart Hub, you must agree to the Smart Hub service agreement and the collection and use of personal information. Without giving consent, you cannot use the additional features and services. You can view the entire text of the [Terms & Policy](#) by navigating to  >  [Settings](#) > [Support](#) > [Terms & Policy](#). [Try Now](#)
-  If you want to stop using Smart Hub, you can cancel the agreement. To cancel the Smart Hub service agreement though it is a required one, select [Reset Smart Hub](#) ( >  [Settings](#) > [Support](#) > [Self Diagnosis](#) > [Reset Smart Hub](#)).

Displaying the Home Screen

Press the  button.

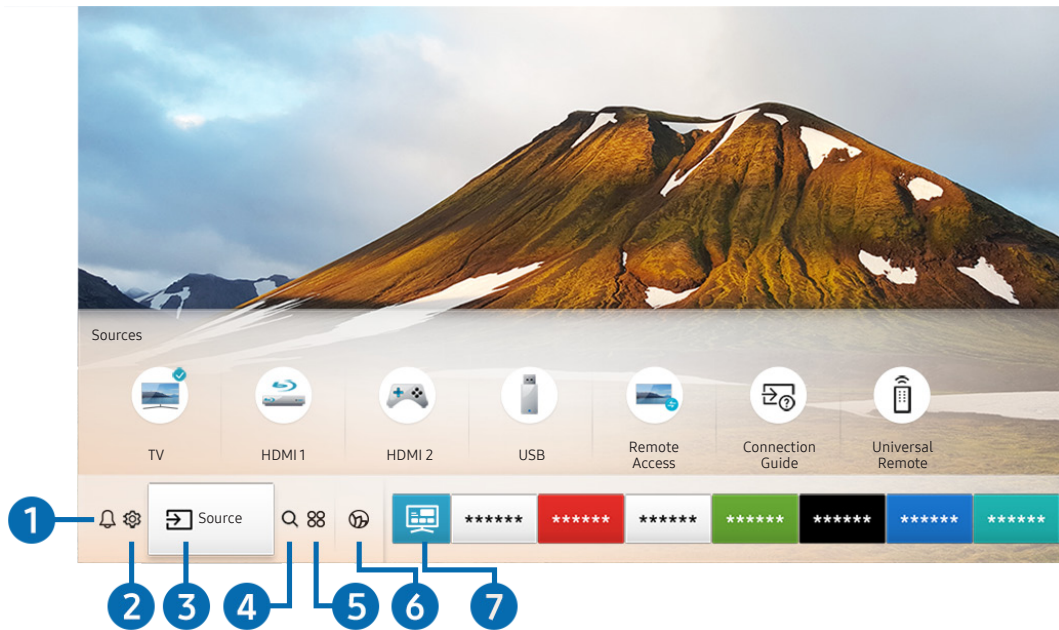



 The image on your TV may differ from the image above depending on the model and geographical area.

On the Home Screen, you can easily run the apps you have used previously or frequently. The apps can also be moved or deleted from the screen.

Notification

You can view a list of notifications for all events that occur on your TV. A notification appears on the screen when it is time to broadcast a scheduled programme or when an event occurs on a registered device.

If you move the focus to **Notification**, and then press the Select button, a notification window appears on the right and the following functions are available:

-  **Delete All**
You can delete all your notifications.
-  **Settings**
 - You can select services you want to be notified about.
 - When you select **Allow sound**, notifications are displayed with a notification sound.

2 Settings

When the focus is moved to **Settings**, a list of quick settings icons appears above the top of the menu. You can quickly set frequently used functions by clicking the icons.

- **e-Manual**

You can open the user manual embedded in your TV.

- **Intelligent Mode**

In **Intelligent Mode**, the TV recognises and analyses the surroundings, the content, and your usage patterns to provide the best viewing experience. To turn **Intelligent Mode** on or off, press the Select button. To set the detailed options, press the up directional button, and then select **Intelligent Mode Settings**.



Because this function is specific to QLED, THE FRAME and SERIF TVs, it may not be supported depending on the model.



For more information about the Intelligent Mode, refer to "[Using the Intelligent Mode](#)".

- **Picture Mode**

You can select the picture mode that provides the best viewing experience. To change the picture mode, press the Select button. To make fine adjustments, press the up directional button, and then select **Picture Setup**.

- **Sound Mode**

You can select a sound mode to optimise your listening experience. To change the sound mode, press the Select button. To make fine adjustments, press the up directional button, and then select **Equaliser Setup**.

- **Sound Output**

You can select which speakers the TV uses for audio output. To change the audio output, press the Select button. To connect to a Bluetooth speaker, press the up directional button, and then select **Bluetooth Speaker List**.



Connecting to a Bluetooth speaker may not be supported depending on the model or geographical area.

- **Game Mode**

You can enable game mode to optimise the TV's settings for playing video games with a gaming console, such as a PlayStation™, Xbox™ or Nintendo Switch™. To turn **Game Mode** on or off, press the Select button. To set the detailed options, press the up directional button, and then select **Go to Game Mode Settings**.



For more information about Game Mode, refer to "[Setting the Viewing Environment for External Devices](#)".



This function is only available when an external input source is being used.

- **Subtitle**

You can watch TV broadcasts with subtitles. To activate/deactivate the **Subtitle** function, press the Select button. To run **Accessibility Shortcuts**, press the up directional button, and then select **Accessibility Shortcuts**.

- **Audio Language**

You can change to the audio language you want to hear. To make fine adjustments, press the up directional button, and then select **Go to Audio Options**.

- **PIP**

While using a connected external device, you can watch a TV broadcast in a small picture-in-picture (PIP) window. To make fine adjustments, press the up directional button, and then select **PIP Setup**.

- **Network**

You can view the current network and Internet status. Press the up directional button, and then select **Network Status** or **Network Settings**.

- **Picture Size**

You can change to the picture size you want to view. To make fine adjustments, press the up directional button, and then select **Go to Picture Size**.

- **Colour Tone**

You can select a colour tone suitable for your viewing preferences. To change to a colour tone that you want, press the Select button.

- **Auto Motion Plus**

You can optimise pictures that contain a lot of motions. To turn this function on or off, press the Select button. To set the detailed options, press the up directional button, move to **Auto Motion Plus Settings**, and then press the Select button.

- **Contrast Enhancer**

You can prevent excessive differences between bright and dark areas on the TV screen. To change the **Contrast Enhancer** setting, press the Select button.

- **Digital Output Audio Format**

You can select an output format for digital audio. Note that the **Dolby Digital+** option is only available via HDMI (ARC) for external devices that support the Dolby Digital+ format.

- **Colour Space**

You can set the spectrum of colours on the TV screen. To change to a colour space that you want, press the Select button. To set the detailed options, press the up directional button, and then select **Colour Space Settings**.

- **TV Device Manager**

You can run **TV Device Manager** to view at a glance and easily optimise the CPU usage, memory usage, and the storage space of the TV.

 Pressing  **Settings** displays all setting menus available.

 These functions may not be supported depending on the model or geographical area.

3 Source

You can select an external device connected to the TV.

 For more information, refer to "[Switching between external devices connected to the TV](#)".

4 Search

You can search for channels, programmes, movie titles, and apps from Smart Hub.

 To use this feature, the TV must be connected to the Internet.

5 APPS



You can enjoy a wide range of content including news, sports, weather, and games by installing the corresponding apps on your TV.

 To use this feature, the TV must be connected to the Internet.

 For more information, refer to "[Using the APPS Service](#)".

6 Ambient Mode

You can enhance your living space with decorative content that matches the surroundings or view essential real-time information such as weather, time, and news on the TV screen when you are not watching TV.

To enter **Ambient Mode**, press the  button. To return to the TV mode, press the  button. To shut off the TV, press the  button.

If you press the  button when the TV is turned off, the TV turns on in **Ambient Mode**.

 If you use a remote control other than the Samsung Smart Remote, there may be restrictions to entering **Ambient Mode**.

 Because this function is specific to QLED and SERIF TVs, it may not be supported depending on the model.

 For more information about the **Ambient Mode**, refer to "[Using the Ambient Mode](#)".

7 Universal Guide

Universal Guide is an app that allows you to search for and enjoy various content such as TV shows, dramas, and movies in one place. **Universal Guide** can recommend content tailored to your preferences.

 For more information about **Universal Guide**, refer to "[Using the Universal Guide App](#)".

 Images may look blurry depending on the service provider's circumstances.

 This function may not be supported depending on the model or geographical area.

Art

When you are not watching TV or when the TV is turned off, you can use the Art mode function to edit image content such as artworks or photos or to display the content.

 This function is supported only in THE FRAME model.

 For more information, refer to the provided user manual.

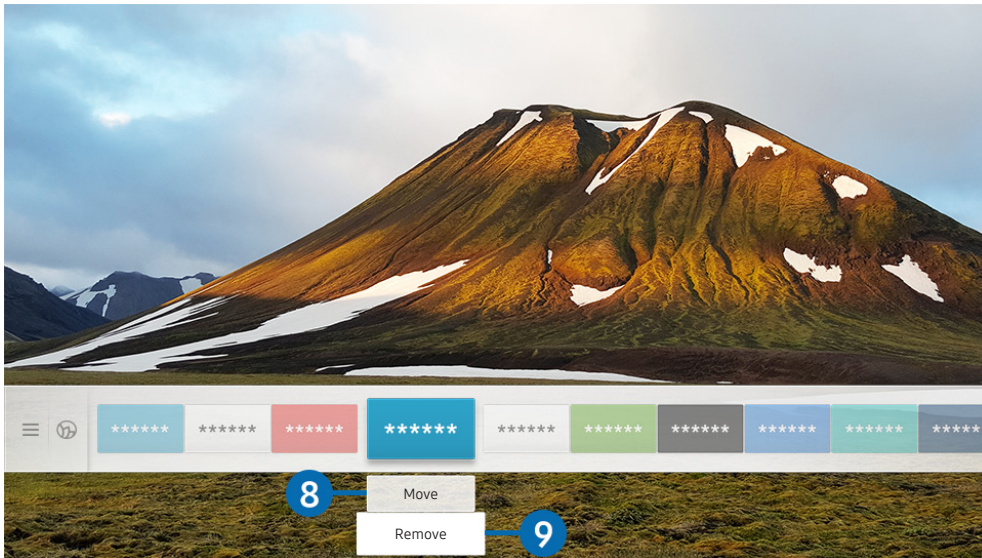

 The image on your TV may differ from the image above depending on the model and geographical area.

8 Moving an item on the Home Screen

Move the focus to the app you want to move, press the down directional button on the remote control, and then select **Move**. Move the app to the desired position by pressing the left or right directional button, and then press the Select button. The selected app is moved on the Home screen.

9 Removing an item on the Home Screen

Move the focus to the app you want to delete, press the down directional button on the remote control, and then select **Remove**. The selected app is deleted.

 You can add the apps you want to use often to the Home Screen using APPS. To add your favourite apps to the Home Screen, refer to "[Managing installed apps](#)".

Launching Smart Hub automatically

 >  [Settings](#) > [General](#) > [Smart Features](#) > [Autorun Smart Hub](#) [Try Now](#)

When you set [Autorun Smart Hub](#) to **On**, the TV displays the Home Screen automatically when you turn the TV on. You can also turn this function on or off. Press the Select button at the current menu.

Launching the last used app automatically

 >  [Settings](#) > [General](#) > [Smart Features](#) > [Autorun Last App](#) [Try Now](#)

If [Autorun Last App](#) is set to **On**, the last used app is automatically run when you turn on the TV. You can also turn this function on or off. Press the Select button at the current menu.



 This function may not be supported depending on the app.

Testing Smart Hub connections

 >  [Settings](#) > [Support](#) > [Self Diagnosis](#) > [Start Smart Hub Connection Test](#) [Try Now](#)

Resetting Smart Hub



 >  [Settings](#) > [Support](#) > [Self Diagnosis](#) > [Reset Smart Hub](#) [Try Now](#)

 You can reset the Smart Hub settings. To reset Smart Hub, enter the PIN. The default PIN is "0000" (for France and Italy: "1111"). You can set the PIN in  >  [Settings](#) > [General](#) > [System Manager](#) > [Change PIN](#).

Using a Samsung account

Create and manage your own Samsung account.

 >  [Settings](#) > [General](#) > [System Manager](#) > [Samsung Account](#) Try Now

 You can view the entire text of the Terms and Privacy Policy in  >  [Settings](#) > [General](#) > [System Manager](#) > [Samsung Account](#) > [My Account](#) > [Terms & Conditions, Privacy Policy](#) after logging in to your Samsung account.

 You can also create a Samsung account at <http://account.samsung.com>. Once you have an account, you can use the same ID on both the TV and the Samsung website.

Signing in to a Samsung account

 >  [Settings](#) > [General](#) > [System Manager](#) > [Samsung Account](#) > [Sign In](#)

Creating a new account

 >  [Settings](#) > [General](#) > [System Manager](#) > [Samsung Account](#) > [Create Account](#)

To create a new Samsung account, follow the instructions on the screen.

 For more information about the terms and conditions, privacy policy, select [View Details](#).

 To protect personal information, select [Profile image selection and password entry \(High security\)](#) in the field below the password entry bar.

 If you want the TV to log you into your account automatically whenever you turn on the TV, click [Stay Signed In](#).

Creating a Samsung account using a PayPal account

 >  [Settings](#) > [General](#) > [System Manager](#) > [Samsung Account](#) > [Create with PayPal](#)

 This function may not be supported depending on the model or geographical area.



Managing your Samsung account

 >  [Settings](#) > [General](#) > [System Manager](#) > [Samsung Account](#) > [My Account](#)

When you sign in to your Samsung account, you can use the following functions:

- [Sign out](#)

When multiple people share the TV, you can sign out of your account to prevent others from seeing it.

 To sign out of your [Samsung Account](#) ( >  [Settings](#) > [General](#) > [System Manager](#) > [Samsung Account](#)), move the focus to your account's icon, and then press the Select button. When a pop-up window appears, select [Sign out](#).

- [Edit profile](#)

You can edit your account information.

- [Payment Info](#)

You can view or manage your payment information.

- [Back up](#)

You can back up the TV settings to your Samsung Cloud storage. When resetting or replacing the TV, you can also restore its settings with the backed-up settings.

- [Sync Internet](#)

Once you sign in to your Samsung account and configure the Sync Internet settings, you can share the favourites and website bookmarks that you registered on other devices.

- [Remove Account](#)

You can delete an account from the TV. Although you have deleted your Samsung account from the TV, you are not unsubscribed. To unsubscribe from your Samsung Account, visit the Samsung Accounts website (<http://account.samsung.com>).

- [Terms & Conditions, Privacy Policy](#)

You can view the user agreement and privacy policy.

Using the Ambient Mode

Learn about the functions available in Ambient Mode that are specific to the QLED and SERIF TVs.

> Ambient Mode

You can enhance your living space with decorative content that matches the surroundings or view essential real-time information such as weather, time, and news on the TV screen when you are not watching TV.

 Because this function is specific to QLED and SERIF TVs, it may not be supported depending on the model.

Entering Ambient Mode

To enter **Ambient Mode** from the TV viewing screen, press the  button, or select  >  **Ambient Mode**.



If you press the  button when the TV is turned off, the TV turns on in **Ambient Mode**.

 If you use a remote control other than the Samsung Smart Remote, there may be restrictions to entering **Ambient Mode**.

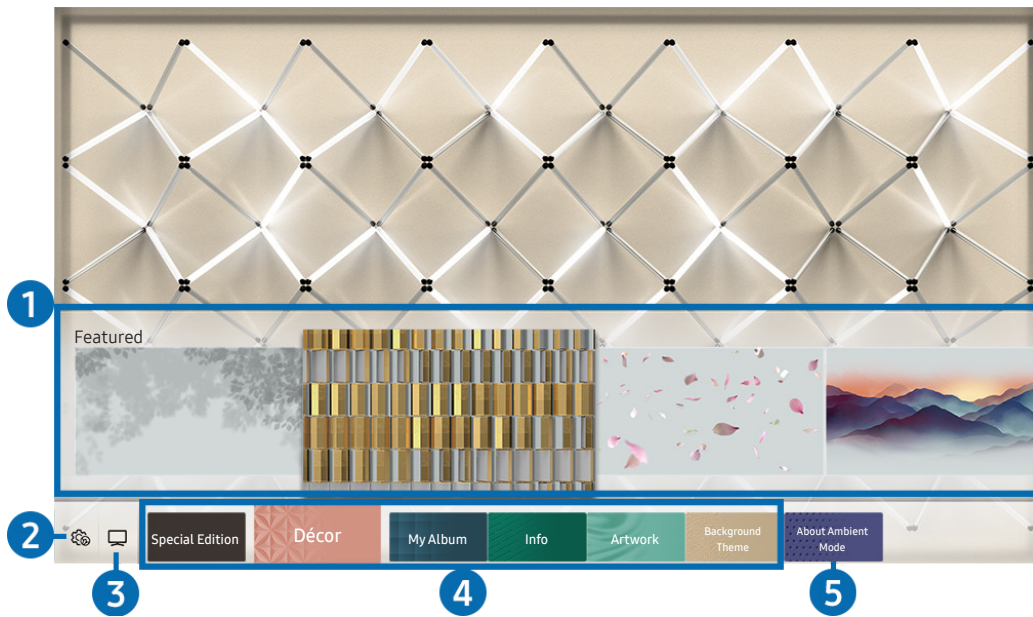
Ambient Mode browser screen



 The image on your TV may differ from the image above depending on the model and geographical area.

When you press the  or  button in **Ambient Mode**, the **Ambient Mode** browser screen appears at the bottom of the screen. In the **Ambient Mode** browser screen, you can select content and change the **Ambient Mode** settings.

1 Function and content preview

When you select a category at the bottom of the screen, a preview of available functions and content appears here. To view detailed information about a content item, move the focus to it, and then press the up directional button.

2 Ambient Settings

You can configure the following **Ambient Mode** settings:

- **Auto Brightness**

Changes the auto brightness setting for **Ambient Mode**.



When this function is set to **Off**, the brightness level of the TV screen is not automatically adjusted in response to the surrounding light level.

- **Sleep After**

Sets the time when the **Ambient Mode** screen turns off automatically.



If there is no remote control input for the set time, the screen goes off. To turn the screen back on in **Ambient Mode**, press the  button on the remote control.

- **Reset All Photos**

Resets the photos imported from your mobile device or Samsung Cloud.

3 TV

You can enter the TV viewing screen.

4 Selecting a content category

You can select your preferred content and background for the **Ambient Mode** screen.

 Available content categories may differ depending on the model or geographical area.

- **Special Edition**

Allows you to enjoy creative artwork and interior design content created by the world's finest artists and designers.

- **Décor**

Allows you to select content with a sensible and beautiful design.

- **My Album**

Allows you to set a photo stored in your mobile device or Samsung Cloud as the wallpaper of the **Ambient Mode** screen.

 To import photos from your mobile device or Samsung Cloud, use the SmartThings app on your mobile device.

 For more information about how to configure the photo settings, select **View Help**. This function is available after you select a photo in the **My Album** category.

- **Info**

Allows you to select essential real-time information such as weather, temperature, time, and news.

 This function may not be supported depending on the geographical area.

- **Artwork**

Allows you to select content such as world famous photos and artwork.

- **Background Theme**

Allows you to select a background theme provided by Samsung.

 Take a picture of a wall using the SmartThings app on your mobile device to create a custom background theme. When you use this function, there may be a delay in image transmission and optimisation depending on network conditions.

 You can set a background theme you created as a background of a content item. To set a background theme as the background of a content item, press the down directional button while watching the **Ambient Mode** screen.

5 About Ambient Mode

You can view information about **Ambient Mode**.

Applying effects to the content

When you are enjoying content in **Ambient Mode**, press the down directional button to change the following settings for the content:

 Available functions may not be supported depending on the content.

- **Backgrounds**

Changes the background of the content.

 This function may not be supported depending on the content.

 You can use the SmartThings app on your mobile device to take a picture of a wall and create a custom background. For more information, select the **How-To** icon. When you use this function, there may be a delay in image transmission and optimisation depending on network conditions.

- **Shadow Effects**

Applies a shadow effect that you select to the content.

 This function may not be supported depending on the content.

- **Brightness**

Adjusts the brightness of the content.

- **Saturation**

Adjusts the saturation of the content.

- **Colour Tone**

Adjusts the colours of the content.

- **Red Tone / Green Tone / Blue Tone**

Adjusts the red, green, blue contrast.

View detailed information about the content

When you are enjoying content in **Ambient Mode**, press the up directional button to view detailed information about the content.

Entering the TV viewing screen from Ambient Mode

To enter the TV viewing screen from **Ambient Mode**, press the  button, or select  **TV** in the **Ambient Mode** browser screen.

 If you press the  button when the TV is turned off, the TV viewing screen appears.

Using the Remote Access

Use the TV to access your PC via remote PC or Screen Sharing (Wireless).



 >  **Source** > **Remote Access**

You can use the TV to access your PC via remote PC or Screen Sharing (Wireless).

 Before running this function, connect your keyboard and mouse to the TV.

- **Remote PC**

Provides the same functionality as Windows **Remote Desktop Connection**. Enter the IP address of the remote access PC or select a profile. To remotely connect to a PC, you must enter a correct user name and password.

 To register a frequently used PC, move the focus to  **Manage User Profiles**, and then press the Select button. When a pop-up window appears, select **Add**, and then enter the PC information.

 To use this function, you must select **Allow remote connections to this computer** in advance on the Windows PC you want the TV to connect to.

 This function is only supported by a Professional or higher edition of Windows 7 or higher.

- **Screen Sharing (Wireless)**

Follow the instructions on the screen to adjust the PC settings and wirelessly connect the TV to the PC.

 This function is only available for PCs that support wireless screen sharing.



 This function is supported by Windows 10.

Using the APPS Service

Download and run various apps from Smart Hub.

> APPS

You can enjoy a wide range of content including news, sports, weather, and games by installing the corresponding apps on your TV.

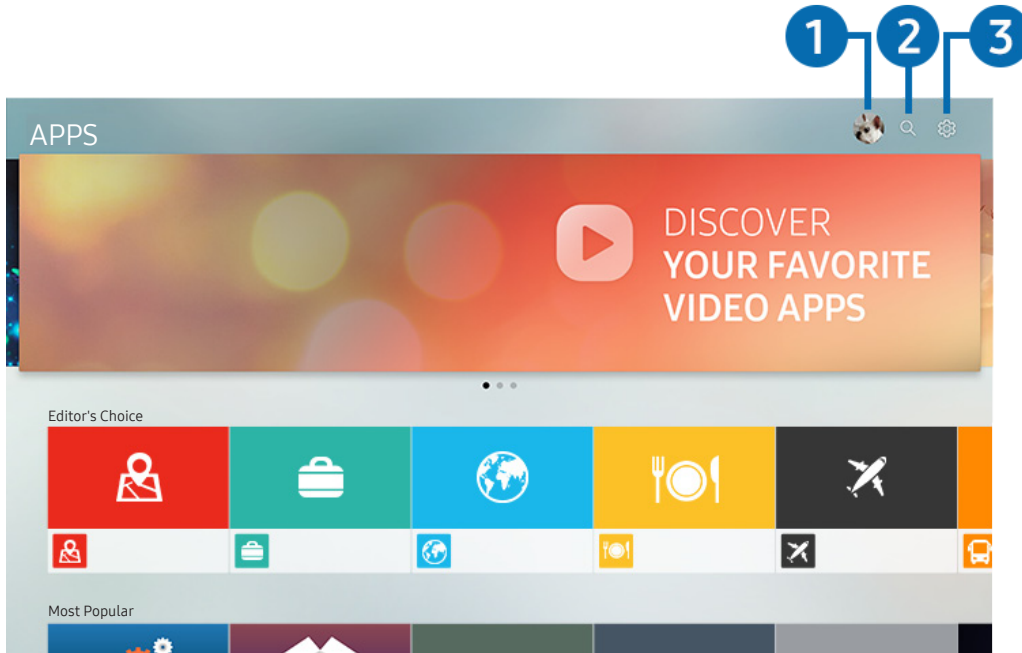

-  To use this feature, the TV must be connected to the Internet.
-  When Smart Hub is launched for the first time, the default apps are automatically installed. The default apps may differ depending on the geographical area.



-  The image on your TV may differ from the image above depending on the model and geographical area.

1 Samsung Account

Go to the [Samsung Account](#) screen to create a new account or sign out of your account.

-  If you are signed out of your Samsung account, select  [Sign In](#) to sign in.
-  If you want to download new apps using **APPS**, first sign in to your Samsung account.

2 App Search

You can search for available apps.

3 Settings

You can manage the installed apps.

Installing an app

1. Move to the app you want to install, and then press the Select button. The detailed information screen appears.
2. Select **Install**. When the installation is completed, the **Open** menu appears.
3. Select **Open** to run the app immediately.

 You can view installed apps on the **Settings** screen.

 If the TV's internal memory is insufficient, you can install some specific apps on a USB device.





 If the USB device is disconnected while an app is running, the app is terminated.

 You cannot run an app installed on a USB device on a PC or another TV.

Launching an app

You can run the app desired from **Downloaded App**.

The icons below appear within the selected app's icon and indicate the following:

-  : The app is installed on a USB device.
-  : The app is locked.
-  : The app needs to be updated.
-  : The app supports mirroring function.

Managing installed apps

Select  **Settings** on **APPS**. You can manage installed apps.

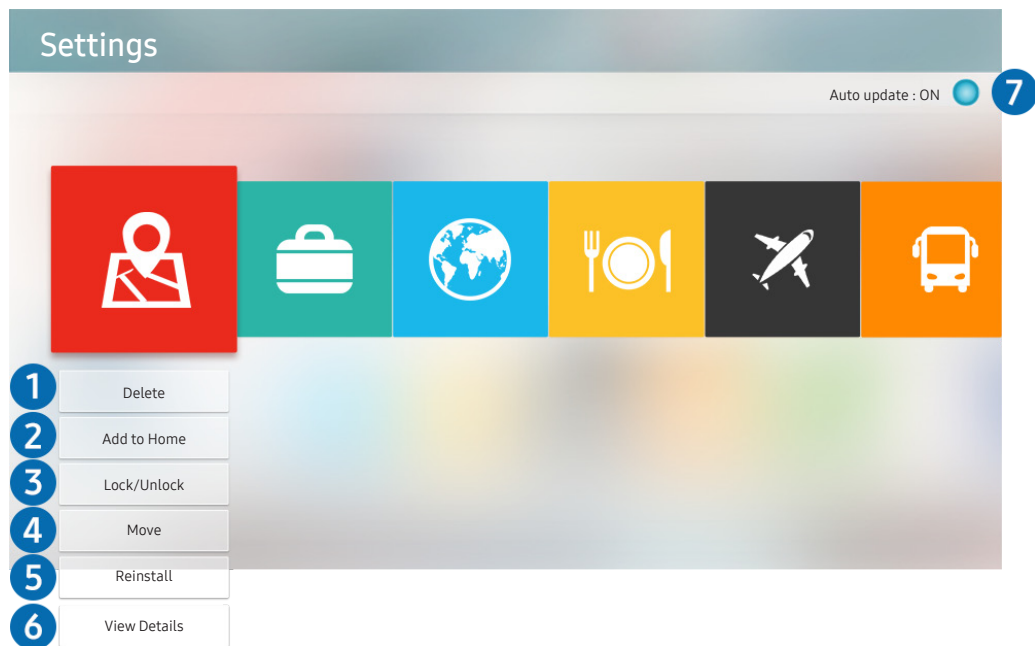

 The image on your TV may differ from the image above depending on the model and geographical area.

1 Removing an app

1. Move the focus to an app to delete.
2. Select **Delete**.

The selected app is deleted.

 Ensure that the related app data is also removed when you remove an app.

 Standard apps cannot be uninstalled.

2 Adding apps to the Home Screen

1. Move the focus to an app to add.
2. Select **Add to Home**.
3. After the Home screen appears, move the selected app to the desired location.
4. Press the Select button.



The selected app is added to the Home Screen.

 If the selected app is already added to the Home Screen, this function is disabled.

3 Locking and unlocking apps

1. Move the focus to an app to lock or unlock.
2. Select [Lock/Unlock](#).

The selected app is locked or unlocked.

 To lock or unlock an app, enter the PIN. The default PIN is "0000" (for France and Italy: "1111"). You can set the PIN in  [Settings](#) > [General](#) > [System Manager](#) > [Change PIN](#).

4 Moving apps

1. Move the focus to an app to move.
2. Select [Move](#).
3. Move the selected app to the desired location.
4. Press the Select button.

The selected app is moved.

 This function may not be supported depending on the model or geographical area.

5 Reinstalling an app

1. Move the focus to the app to install again.
2. Select [Reinstall](#).

Reinstallation starts.

6 Checking the app information details

1. Move the focus to the app to check.
2. Select [View Details](#).

The app information screen appears.

 You can rate an app on the [View Details](#) screen.

7 Automatically updating apps

To automatically update the installed apps, set [Auto update](#) to **ON**.

 Automatic update is enabled only when the TV is connected to the Internet.

Using the Gallery App

View photos and videos synchronised with the Samsung Cloud.

 > Gallery

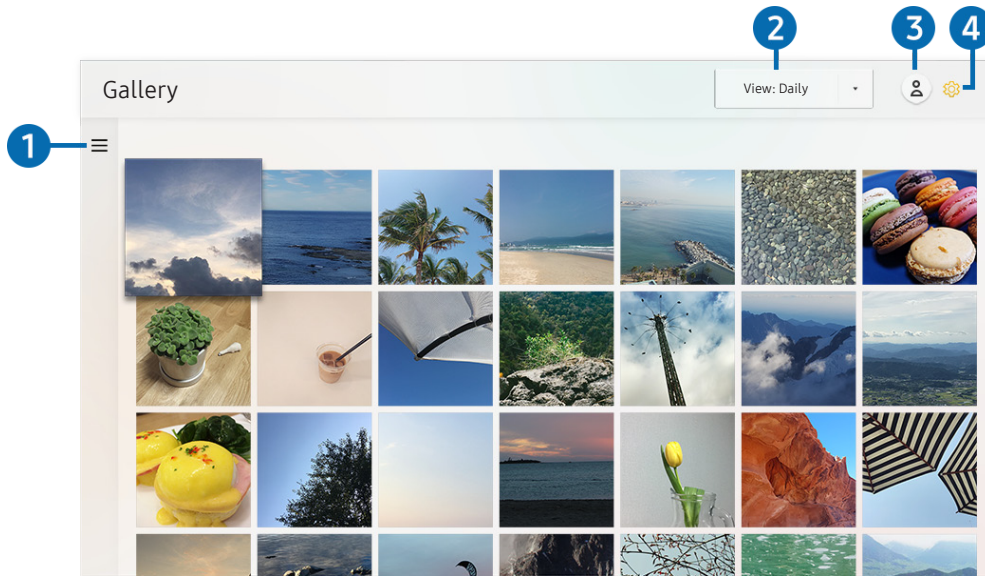

 The image on your TV may differ from the image above depending on the model and geographical area.

You can enjoy various content synchronised with a mobile device that supports the Samsung Cloud. The available content types are photos, videos, stories, and other content shared through your groups.

If you have shared content from your groups, you can access them in notifications.

 To use the **Gallery** app, you must be signed in to your Samsung account that uses the Samsung Cloud.

 To use this function, the PIN number is required.

1 Open category

Move to  at the top left of the screen using the directional buttons on the remote control to view the content synchronised with the Samsung Cloud by category.

2 **View: Daily / View: Monthly**

Sort the content by day or month.

3 Samsung Account

Go to the **Samsung Account** screen to create a new account or sign out of your account.

 If you are signed out of your Samsung account, select  **Sign In** to sign in.

4 Gallery Settings

Set a PIN for screen lock to restrict access to the **Gallery** app, or view the terms and condition.

Using the Universal Guide App

Search for and enjoy content such as TV shows, dramas, movies, and sports broadcasts.



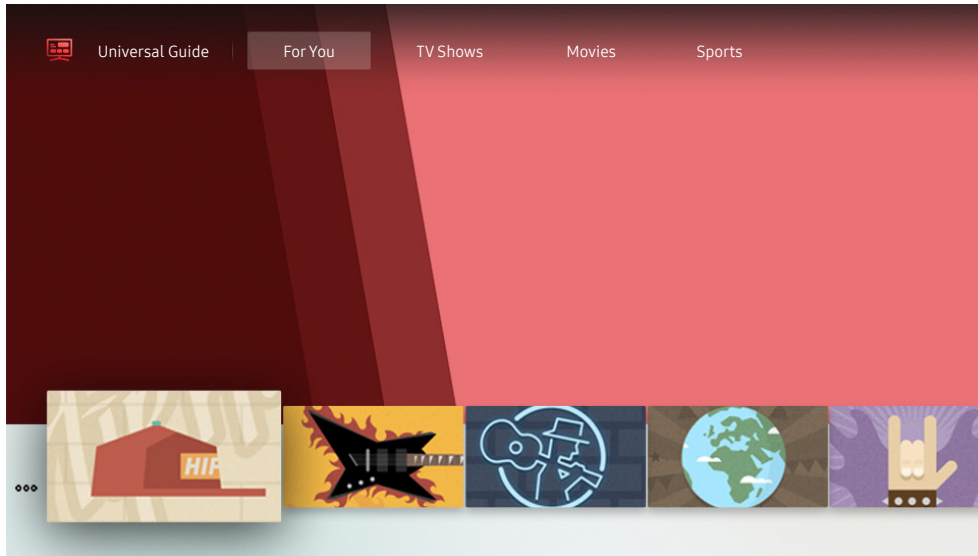



 >  Universal Guide



 The image on your TV may differ from the image above depending on the model and geographical area.

Universal Guide is an app that allows you to search for and enjoy various content such as TV shows, dramas, and movies in one place. **Universal Guide** can recommend content tailored to your preferences.

You can use this feature on your mobile device with the Samsung SmartThings app.

-  To enjoy the content from these apps on your TV, they must be installed on the TV.
-  When you watch some paid content, you may need to make a payment using their associated app.
-  Some content may be restricted depending on your network conditions and your subscriptions to paid channels.
-  Parental control is necessary when children use this service.
-  Images may look blurry depending on the service provider's circumstances.
-  This function may not be supported depending on the model or geographical area.

Using the SmartThings App

Monitor and configure the smart devices you have connected to the SmartThings service.

 > SmartThings

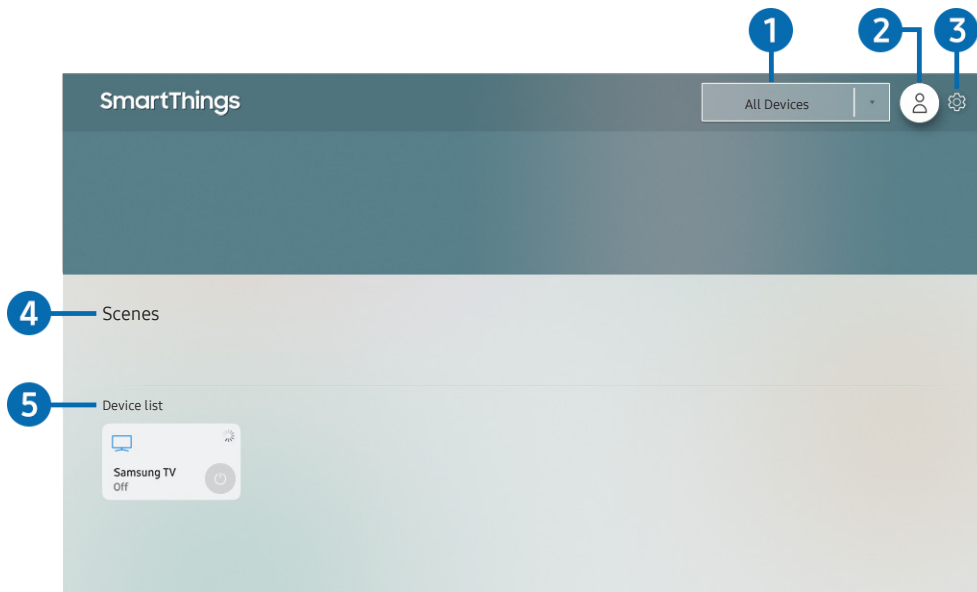

 The image on your TV may differ from the image above depending on the model and geographical area.

From the TV, you can monitor and configure your smart devices connected to the SmartThings service via the SmartThings app installed on them. You can receive notifications about the statuses of your connected devices.

 To use this function, you must be logged in to your Samsung account.

 This function may not be supported depending on the model or geographical area.

1 Location selection list

Press the Select button to identify all connected devices or the devices specific to a location.

2 Samsung Account

Go to the [Samsung Account](#) screen to create a new account or sign out of your account.

 If you are signed out of your Samsung account, select  [Sign In](#) to sign in.

3 Settings

Turn notifications on or off for the connected smart devices.

4 Scenes

Control multiple devices with one command after setting scenes via the SmartThings app on your mobile device.

5 Device list

View a list of the connected smart devices and their statuses.

You can add a new device through the SmartThings app on your mobile device. Please refer to the user guide in the SmartThings app on your mobile device for more details.

Using the e-Manual

Control and read the manual embedded in your TV.

Launching the e-Manual

 >  **Settings** > **Support** > **Open e-Manual**

You can view the embedded e-Manual that contains information about your TV's key features.

 You can download a copy of the e-Manual from Samsung's website to view or print on your PC or mobile device (<http://www.samsung.com>).

 Some menu screens cannot be accessed from the e-Manual.

Using the buttons in the e-Manual

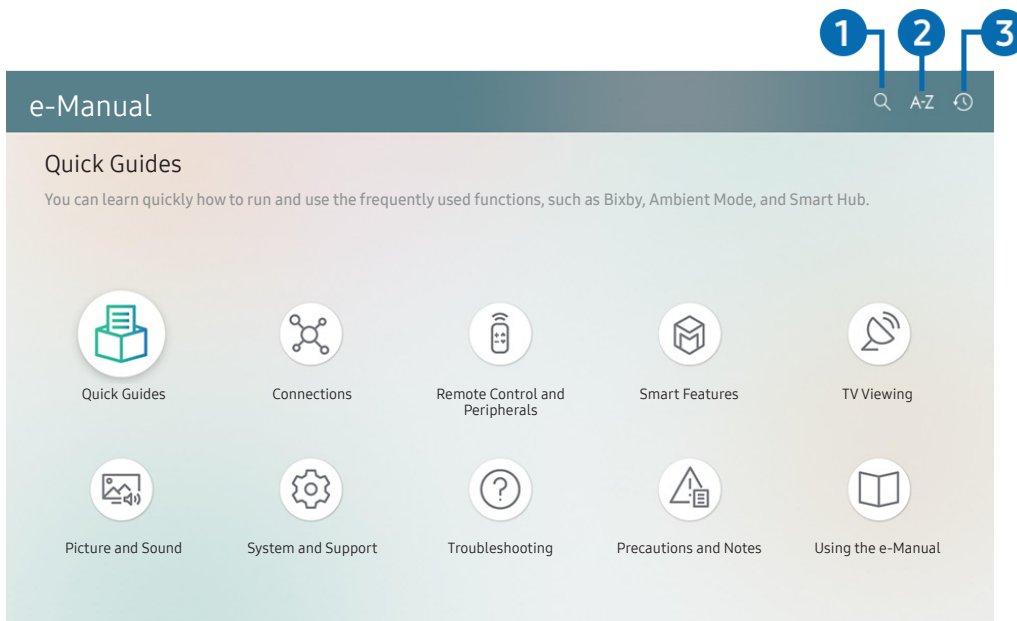

 The image on your TV may differ from the image above depending on the model and geographical area.

1 (Search)

Select an item from the search results to load the corresponding page.

2 **A-Z** (Index)

Select a keyword to navigate to the relevant page.

 The menus may not appear depending on the geographical area.

3 (Recent pages)

Select a topic from the list of recently viewed topics.

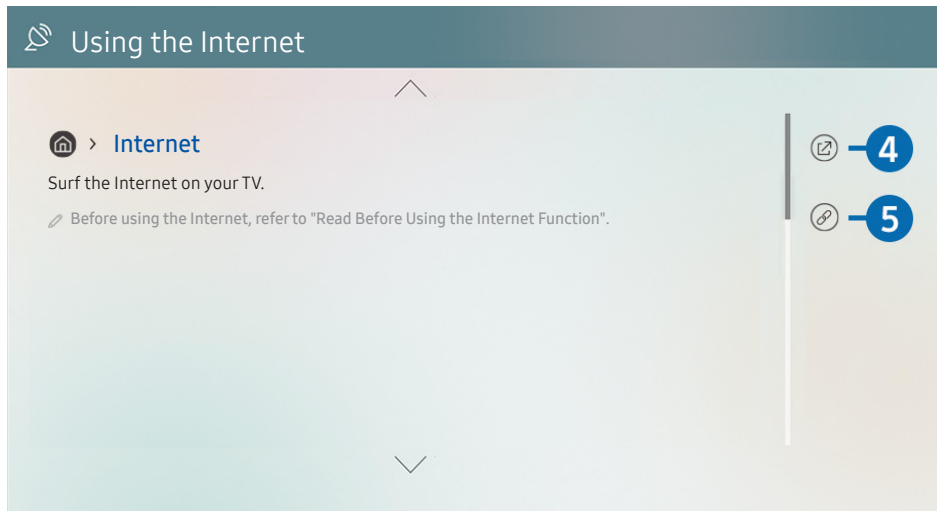

 Words in blue (e.g., **Internet**) indicate a menu item.

 The image on your TV may differ from the image above depending on the model and geographical area.

4 (Try Now)

Allows you to access the corresponding menu item and try out the feature right away.

5 (Link)

Access an underlined topic referred to on an e-Manual page immediately.

Using the Internet

Surf the Internet on your TV.

> **Internet**

When you run **Internet**, you can see recently viewed web sites or featured recommendations. When you select a desired web site, you can get immediate access to it.

 You can use the **Internet** more easily after connecting a keyboard and mouse.

 You can scroll web pages with the directional pad on the Samsung Smart Remote.

 The web pages may differ from those on a PC.

 Before using the **Internet**, refer to "Read Before Using the Internet Function".

Playing pictures/video/music

Play media content stored on your TV, USB devices, mobile devices, cameras, PCs, etc.

Home > Source > Connected Device Try Now

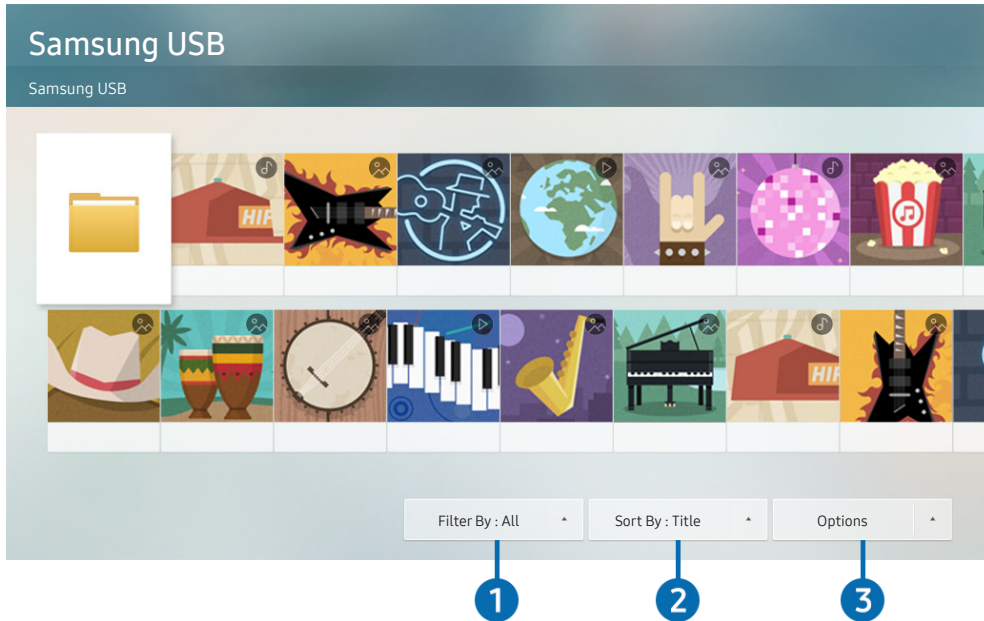

The image on your TV may differ from the image above depending on the model and geographical area.

You can play media content saved on storage devices, such as USB devices, mobile devices, and cameras, on the TV.

You cannot play media content if the content or the storage device is not supported by the TV. For more information, refer to "[Read Before Playing Photo, Video, or Music Files](#)".

Backup important files before connecting a USB device. Samsung is not responsible for damaged or lost files.

You can use the following functions on the media content list screen of a storage device.

1 Filter By

Filters the media content by type of media.

2 Sort By

Sorts the content list.

 This function may not be supported depending on the type of external device.

3 Options

Deletes or plays the selected media content in the media content list. When you select **Refresh**, the content list is reloaded.

 You can delete only the recorded content. To delete content, change the **Filter By** option to **Recorded**.

Playing multimedia content on a PC or mobile device

1. Select a device with media content in  >  **Source**. The media content list in the device appears.
2. Select a media content item from the list.



The selected content is played.

 The content may not be played depending on the encoding method or file format. Furthermore, several functions may be restricted.

 Content on devices connected to the TV via your network may not play smoothly due to the network communication problems. If this occurs, use a USB device.

Playing multimedia content on a USB device

1. Connect a USB device to the USB port.
2. When a pop up message appears on the screen, select **Browse** to easily move to the list of multimedia content stored on the device.

 If a USB device that contains the content you want to play is already connected to the TV, select the USB device in the  >  **Source** screen.

3. Select a content item to play from the list.

The selected content is played back.

Listening to your mobile device sound through the TV speaker using Sound Mirroring

1. Search for and connect to your TV from the  (Bluetooth) device list on your mobile device.
2. Select media content to play on your mobile device.

The selected contents media is played through the TV speaker.



 Some models enter **Ambient Mode** automatically, and then play the selected media contents.

 This function may not be supported depending on the TV model.





 If the TV and the sound bar are connected wirelessly, the operation may be restricted.

Buttons and functions available while playing multimedia content

Press the Select button while playing any video, photo, or recorded content. The following buttons appear.

-  The provided buttons and functions may not be supported depending on the model or geographical area.
-  The available buttons and functions may differ with the content you are viewing or playing.
- **Pause / Play**

Pauses or plays the multimedia content. You can use the following functions when the video is paused.



 - **Slow Rewind** or **Slow Forward**: Allows you to play the video slowly backward or forward by selecting the  or  option. To change the playback speed in 3 levels, press the option repeatedly. To return to normal speed, select the  option or press the  button.
- **Jump Backward / Jump Forward**

Press the up directional button to move the focus to the playback control bar, and then select the left or right directional button in the playback control bar to move backward or forward by 10 seconds in the video.
- **Move to a specific playback section**, move up the focus on the playback bar, and then select one of the five thumbnails.

 This function may not be supported depending on the file format.
- **Stop**





Stop the contents being played.
- **Previous / Next**

Displays the previous or the next multimedia content file.
- **Rewind / Fast Forward**

Rewinds or fast forwards the multimedia content. To increase the rewind or fast forward speed up to 3 times faster than normal, select the button repeatedly. To return to normal speed, select the  option or press the  button.

- **360 Mode**

Provides a 360-degree view for videos and photos.









-  This function may not be supported depending on the file format.
-  Video files using the mjpeg codec do not support a 360-degree view.
-  When a video or photo does not support a 360-degree view, applying 360 rotation to it may cause the screen to look distorted.
-  Videos may be interrupted if 360 rotation is applied during double speed playback.
-  Videos that support a 360-degree view may be interrupted if 360 rotation is simultaneously applied with other functions during playback.

- **360 Auto Rotation**

Automatically adjusts the video's viewing angle by analysing the amount of image changes during playback of a video file that provides a 360-degree view. When this function is started, the rotation starts in a short time.

When **360 Auto Rotation** is focused, press the Select button to change to the following modes:

- **General**
- **Dynamic**
- **Natural**

-  This function is only available when **360 Mode** is selected.
-  Even if you watch the same video file in the same **360 Auto Rotation** mode, the current effect of this function may differ a little from the previous effects.
-  The video's viewing angle is not automatically adjusted in **General** mode.
-  This function may not be supported depending on the file format.
-  Video files that use the mjpeg codec do not support a 360-degree view.
-  When a video does not support a 360-degree view, applying 360 rotation to it may cause the screen to look distorted.
-  Videos may be interrupted if 360 rotation is applied during double speed playback.
-  Videos that support a 360-degree view may be interrupted if 360 rotation is simultaneously applied with other functions during playback.

- **Repeat**

Plays the current multimedia content repeatedly or all multimedia content files in the same folder repeatedly.

- **Shuffle**





Plays music files in random order.

- **Picture Off**

Plays music files with the screen off.





- **Fit to Screen**
Fits a photo to the screen.
- **Rotate left / Rotate right**
Rotates a photo left or right.
- **Zoom**
Zooms in a photo.
- **Background Music**
Pauses or resumes the background music while the TV displays photos.
- **Options**

 The available options may differ with the model and content.



Function	Description
Slideshow Speed	Sets the slideshow speed.
Slideshow Effect	Applies transition effects to the slide show.
Background Music	Plays background music as you set in the pop-up window while the TV displays photos.  The music files must be saved in the same USB device as the photo files.  To pause the background music, select Background Music on the playback screen bottom.
Subtitles	You can set the detailed subtitle options such as the language, sync, size, and colour.  If subtitles are not displayed correctly, check the encoding setting.
Rotate	Rotates the video.
Audio Language	Changes the audio language you want to hear.  This function is only available if the video supports multi-track sound.
Information	Displays detailed information about the current multimedia content.

Using Bixby



Speak into the microphone on your Samsung Smart Remote to control your TV.

-  Bixby is available only when the TV is connected to the Internet.
-  To use Bixby, you must register and sign in to your Samsung account. Some functions may not be supported if you are not signed in to your Samsung account.
-  Bixby only supports some languages, and the supported functions may differ depending on the geographical area.
-  Bixby may not be supported depending on the model or geographical area.

Starting Bixby with voice

You can immediately start a conversation with Bixby by saying "Hi, Bixby." Say "Hi, Bixby," and the Bixby icon at the bottom of the TV screen is activated in Listen mode. Continue speaking. If Bixby does not respond to your voice, turn on the [Voice Wake-up](#) function, and then try again. ( > [Explore Now](#) >  [Settings](#) > [Voice Wake-up](#))

Starting Bixby using buttons on the Samsung Smart Remote

You can also have a conversation with Bixby using the Samsung Smart Remote buttons. Press and hold the  button on your Samsung Smart Remote, say a command, and then release the  button.

To view the Bixby guide, press the  button once:

- When you press the  button, the [Explore Now](#) button appears at the bottom of the screen. Press the Select button to go to the [Explore Bixby](#) screen.

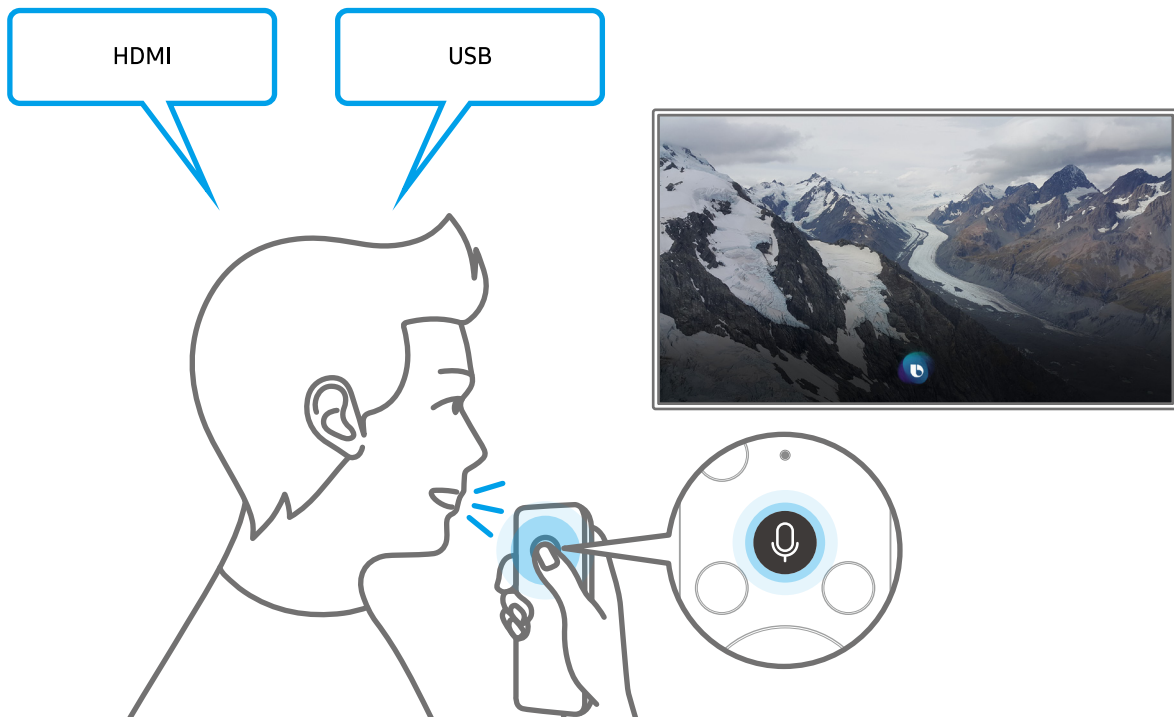

Learning about the Explore Bixby Screen

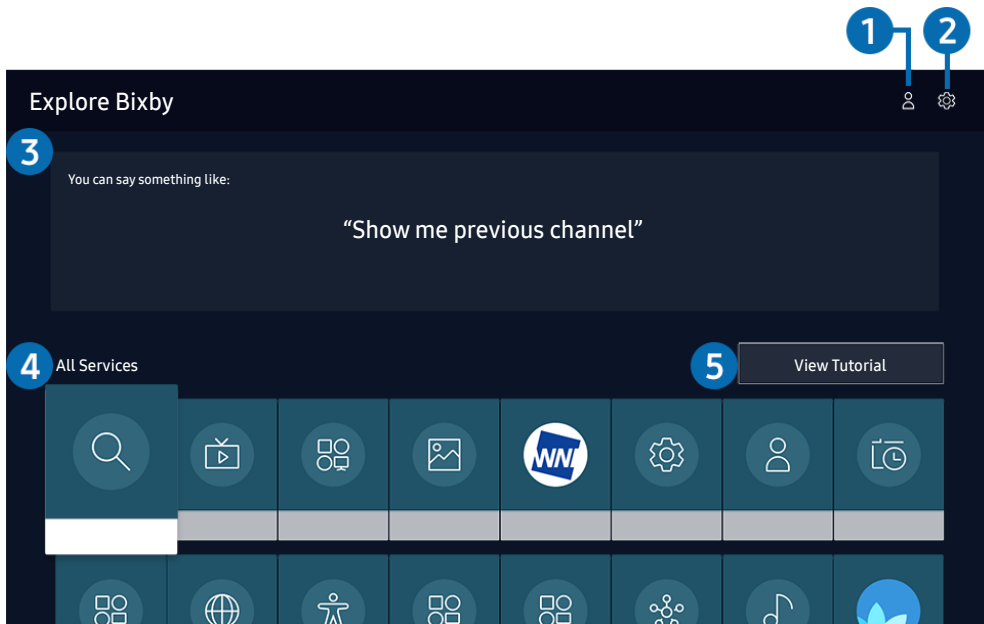

 The image on your TV may differ from the image above depending on the model and geographical area.

1 My Profile

Go to the [My Profile](#) screen to create a new account or register a voice ID. Sign in to your account with your voice, that is, your registered voice ID.

 If you are signed out of your Samsung account, select  [My Profile](#) to sign in.

2 Settings

You can change the settings for using Bixby.

 These functions may not be supported depending on the model or geographical area.

- **Language**

You can change Bixby's language.

 The languages of the TV and other apps will not change.

 Bixby only supports some languages.

- **Voice response**

You can change or turn off Bixby's voice.

 This function may not be supported depending on the language selected for Bixby.

- **Voice Wake-up**

You can configure this function to make Bixby respond to your voice.

 This function may not be supported depending on the model or geographical area.

- **Privacy**

You can permit or prohibit Bixby from utilising your personal information when you are using Bixby services.

3 Recommended commands

Displays recommended commands you can use to control the TV with Bixby given the current context.

4 All Services

You can learn the voice commands that let you use Bixby in various situations. Use the directional buttons to move to the desired command, and then press the Select button. You can operate the TV with various voice commands.

5 View Tutorial

The popup window on using Bixby appears.

Read Before Using Bixby

- The supported voice interaction languages and features may differ depending on the geographical area.
- If the language set differs from the language of your country, some features are not available.
- Bixby is available only when the TV is connected to the Internet.
- Even if the TV is connected to the Internet, there may be no response due to a Bixby server error.

- The existing functional specifications may be changed if Bixby is updated.
- Bixby is available only on TVs that support it and come with remote controls that have a microphone.
- Symbols including "-" and special characters are not supported. Consequently, if a word or sentence contains numeric values or symbols, the function may not operate properly.
- Searched results may not provide complete results.
- You may be required to pay for some apps. Consequently, you may encounter a service application or contract.
- To change the current channel by saying channel names as voice commands, you must finish [Set Up Your Service Provider](#). If [Set Up Your Service Provider](#) is not completed, you can complete it using [Reset](#) (🏠 > ⚙️ [Settings](#) > [General](#) > [Reset](#)). [Try Now](#)
- To use the voice text input function and the search function, you must consent to provisions allowing third parties to collect and use your voice data.
- To use the Bixby function, you must:
 - Agree to Smart Hub's Terms of Use
 - Agree to a guidance regarding the collection and use of personal information for the Smart Hub service.
 - Consent to the collection and use of personal information for the voice interaction-based service.

Provisions for using Bixby

- The voice interaction rate differs with the volume/tone, pronunciation, and ambient sound environment (TV sound and ambient noise).
- The optimal volume for voice commands is between 75 dB and 80 dB.

TV Viewing

You can use convenient features while watching TV. Additionally, you can edit the channel list or create favourite channel lists.

Using the Guide

See an overview of each channel's programme lineup.

 > [Live TV](#) > [Guide](#) Try Now

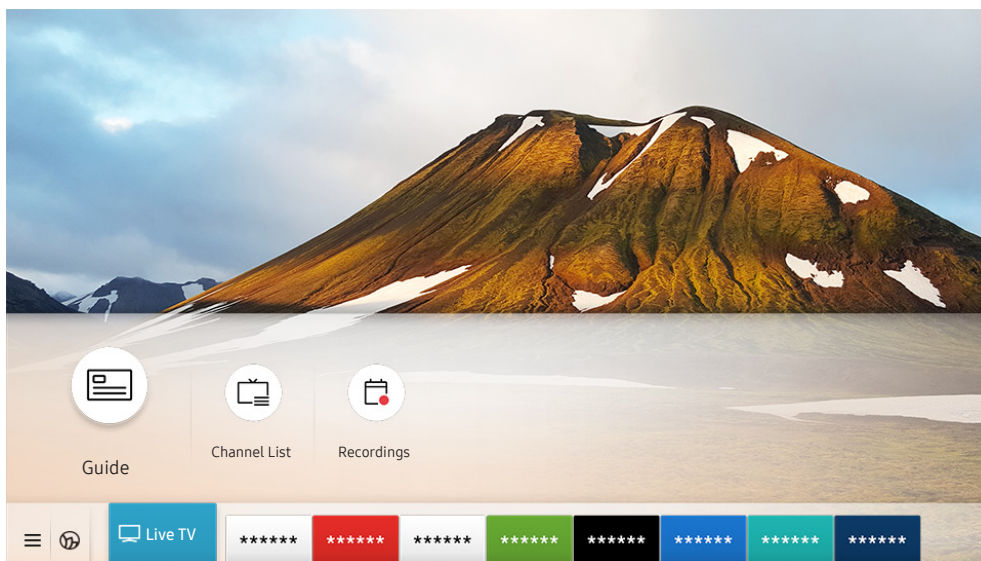

 The image on your TV may differ from the image above depending on the model and geographical area.

In the [Guide](#), you can see the daily programme schedules for each broadcaster, see programme information, choose a programme to watch, and set up a schedule viewing or recording.

 To view the [Guide](#) while watching TV, press the CH button on the Samsung Smart Remote or press the GUIDE button on the standard remote control.

 To see information about analogue channels and use the analogue channel functions of the [Guide](#), you must finish the service provider settings in initial setup.

 To view the [Guide](#), you must first set the TV's clock ( >  [Settings](#) > [General](#) > [System Manager](#) > [Time](#) > [Clock](#)).

Move the focus to the programme you want in the [Guide](#), and then press and hold the Select button. You can use the following functions:

- **Record**

You can record the programme that you are currently watching or a programme on another channel.



This function may not be supported depending on the model or geographical area.

- **Stop**

You can stop the recording function that is currently running.

- **Edit Recording Time**

You can change the start and end times of scheduled programme recordings.



This function may not be supported depending on the model or geographical area.

- **Schedule Viewing**

You can schedule the viewing of a broadcast scheduled programme.



This function may not be supported depending on the model or geographical area.

- **Schedule Recording**

You can schedule recording of a broadcast scheduled programme.



This function may not be supported depending on the model or geographical area.



- **Cancel Scheduled Viewing / Cancel Scheduled Recording**

You can cancel scheduled viewings and recordings.

 This function may not be supported depending on the model or geographical area.

- **View Details**

You can see detailed information about the selected programme. The information may differ or may not be provided depending on the broadcast signal.

To move to the **Channel Filter**, **Schedule Manager**, or **Aerial Type** screen: Press the  or  button. (If the remote control button is , press it twice.)

- **Channel Filter**

You can view channels and programmes categorised by the types defined in **Channel List**.

- **Schedule Manager**

You can see the **Schedule Manager** or **Recording & Schedule Manager** screen.

- **Aerial Type**







You can change the broadcast signal the TV receives.

 This function may not be supported depending on the incoming broadcast signal.

 These functions may not be supported in the **Guide** depending on the model or geographical area.

Recording Programmes



Record a current or upcoming programme using a USB device instead of a video recorder.

-  Read all precautions before using the recording feature. Refer to "[Before Using the Recording and Timeshift Functions](#)" for more information.
-  You can record only the programmes that have been received through an aerial.
-  The  appears next to the programmes that have been configured for a scheduled viewing.
-  This function may not be supported depending on the model or geographical area.
-  If you go to  > **Live TV** while no USB device is connected, the **Schedule Manager** screen appears in place of the **Recordings** screen.

Using the instant and schedule recording options from the Guide screen

- **Instant Recording**
Select a live programme from the **Guide**, press and hold the Select button, and then select **Record** from the pop-up menu to start recording immediately.
- **Schedule Recording**
Select a programme scheduled to be broadcast, press the Select button, and then select **Schedule Recording** to set up a schedule recording of the scheduled programme.

Using the instant and schedule recording options while watching a programme

- **Instant Recording**
If you select **Record** after pressing the  button twice or after pressing the  button once while watching a broadcast, recording starts.
- **Schedule Recording**
Press the Select button while watching a programme to display the programme info window. Use the left or right directional button to select a scheduled programme. Press the Select button, and then select **Schedule Recording** to set up a schedule recording of the scheduled programme.

Scheduling a video recording after entering the date and time

 > [Live TV](#) > [Schedule Manager](#) or [Recordings](#) > [Schedules](#) > [Add Recording](#)

To schedule a recording, set the values for [Aerial](#), [Channel](#), [Repeat](#), [Date](#), [Start Time](#), and [End Time](#) of the broadcast programme to record, and then select [Save](#).

 Check the current time in  >  [Settings](#) > [General](#) > [System Manager](#) > [Time](#) > [Clock](#).

 The menus may not appear depending on the model or geographical area.

Managing the schedule recording list

 > [Live TV](#) > [Schedule Manager](#) or [Recordings](#) > [Schedules](#)

You can change scheduled recording information or cancel scheduled recordings.

 The menus may not appear depending on the model or geographical area.

 You can schedule up to 30 recordings or viewings at once using [Schedule Recording](#) and [Schedule Viewing](#).

- [Edit](#)

You can set the start and end times for a schedule recording. You can set the start time up to 10 minutes before the programme starts and the end time up to 10 minutes after the programme ends.

 The menus may not appear depending on the model or geographical area.

- [Delete](#)

You can delete scheduled recordings.

 The menus may not appear depending on the model or geographical area.

- [View Details](#)

You can view detailed information about scheduled recordings.

 The menus may not appear depending on the model or geographical area.

Viewing recorded programmes

 > [Live TV](#) > [Schedule Manager](#) or [Recordings](#) > [Recordings](#)

Select a file containing a recording from the list. The file is played back.

Move the focus to the recorded file, and then view [Play](#), [Delete](#) or [View Details](#) on the right menu.

 Buttons that appear may differ depending on the file being played. For more information about control buttons, refer to "[Buttons and functions available while recording a programme or Timeshift](#)".

 The menus may not appear depending on the model or geographical area.

Setting up a schedule recording start

 > [Live TV](#) > [Schedule Manager](#) or [Recordings](#) > [Settings](#)

- [Start Recording Early](#)

You can set the time to start the recording earlier than the broadcast start time in the programme guide.

- [Continue Recording After](#)

You can set the time to end the recording later than the broadcast end time in the programme guide.

- [Symbol Information](#)

Provide users with the information of the symbol and the explanation about an icon used in the schedule manager.

 The menus may not appear depending on the model or geographical area.

Setting Up a Schedule Viewing

Configure the TV to show a specific channel or programme at a specific time and date.

 The  appears next to programmes that have been configured for a schedule viewing.

 To set up a schedule viewing, you must first set the TV's clock ( >  [Settings](#) > [General](#) > [System Manager](#) > [Time](#) > [Clock](#)).

Using the schedule viewing options from the guide screen

On the [Guide](#) screen, select a programme you would like to view, press the Select button, and then select [Schedule Viewing](#) in the pop-up menu that appears.

Using the schedule viewing options while watching a programme

Press the Select button while watching TV. The Programme Info window appears. Select a programme that will be broadcast using the left or right directional buttons. Press the Select button, and then select [Schedule Viewing](#) to schedule viewing of that programme.

Using schedule viewing to view programmes at a specified time on a specified date

 > [Live TV](#) > [Schedule Manager](#) or [Recordings](#) > [Schedules](#) > [Add Viewing](#)

To schedule a Viewing, set the values for [Aerial](#), [Channel](#), [Repeat](#), [Date](#), and [Start Time](#) of the broadcast programme to record, and then select [Save](#).

Check the current time in  >  [Settings](#) > [General](#) > [System Manager](#) > [Time](#) > [Clock](#).

 The menus may not appear depending on the model or geographical area.

Setting the Schedule Viewing Time

 > [Live TV](#) > [Schedule Manager](#) or [Recordings](#) > [Schedules](#)

You can change scheduled recording information or cancel scheduled recordings.

 The menus may not appear depending on the model or geographical area.

 You can set up a maximum total of 30 [Schedule Viewing](#) and [Schedule Recording](#) entries.

- [Edit](#)

You can set the start time of a schedule viewing. If you choose a programme from the [Guide](#), the [Start Time](#) can be set to up to 10 minutes before the programme.

- [Delete](#)

You can delete scheduled viewings.

- [View Details](#)



You can view detailed information about scheduled viewings.







Using Timeshift

Play, pause, or rewind live TV.

You can pause and rewind live TV by using **Timeshift**. Activating this function disables the **Broadcasting** function.



Try Now

To activate the **Timeshift** function while watching TV, press the  button twice or press the  button press the **Select** button and then select **Timeshift**, or press the  button.

-  When the Timeshift function is running, some of function are not available in  >  **Settings** > **Broadcasting**.
-  To use Timeshift, you must connect a USB device for recording.
-  Read all precautions before using the Timeshift function. For more information, refer to "[Before Using the Recording and Timeshift Functions](#)".
-  This function may not be supported depending on the model or geographical area.

Buttons and functions available while recording a programme or Timeshift



Review available buttons and functions of how they are used while recording a programme or Timeshift.

-  The available buttons and functions may differ with the functions.
-  This function may not be supported depending on the model or geographical area.

When you press the down directional button, the control bar appears and the following options are available:

- **Pause / Play**

You can use the following functions when the video is paused. Note that with the video paused, the TV does not play audio.

- **Slow Rewind** or **Slow Forward**: Allows you to play the video slowly (1/8, 1/4, 1/2) backward or forward by selecting the  or  option. To increase the rewind or forward speed in slow mode up to 3 times, select the option repeatedly. To return to normal speed, select the  option.

-  When the **Slow Rewind** function is activated, you can view the difference between the current recording time and the current rewind time.

- **Jump Backward / Jump Forward**

Press the up directional button to move the focus to the playback control bar, and then select the left or right directional button in the playback control bar to move backward or forward by 10 seconds in the video.



When the Jump Backward function is activated, you can view the difference between the current recording time and the current rewind time.

- **Rewind / Fast Forward**



This function is not available while you are watching a programme that is currently being broadcast.

- **Stop Recording / Stop Timeshift**

Ends the recording or Timeshift function.

- **Record**

You switch from the Timeshift function to the recording function. When switching to the recording function, you can include the content recorded by the Timeshift function into the new recording.



This function is only available when the Timeshift function is running.

- **Edit Recording Time**

You can set for what period of time the programme will be recorded.



This function is only available when a programme is being recorded.

- **Go to Live TV**

Select to return to the current scenes of the programme when the Timeshift function is playing its past scenes.

- **Info**

Displays the programme info window about the programme on which the recording or Timeshift function is working.



Using the Channel List

Change the channel or check programmes on other digital channels.







> [Live TV](#) > [Channel List](#)

Using the [Channel List](#), you can change the channel or check programmes on other digital channels while watching TV. On standard remote control, press the CH LIST button.

The [Channel List](#) screen contains the following icons:

-  : A favourite channel
-  : A locked channel.
-  : CI card required channel.

If you press the right directional button when viewing the [Channel List](#) screen, you can use the following functions:



- [All](#)
Displays the channels that have been automatically searched.
 The channels received to the currently selected [Terrestrial](#), [Cable](#), or [Satellite](#) are displayed.
- [Samsung TV Plus](#)
While the TV is connected to the Internet, you can watch popular programmes or highlights for each theme through a virtual channel at any time. As with regular channels, the TV provides the daily programme schedules for [Samsung TV Plus](#).
 This function may not be supported depending on the model or geographical area.
- [Favourites](#)
Displays [Favourites 1](#) to [Favourites 5](#).
- [Channel Type](#)
Sorts the list so that it includes channels of a selected type. However, [Channel Type](#) can only be used channels contain the type information.
 This function may not be supported depending on the incoming broadcast signal.
- [Sort](#)
Sorts the list by [Number](#) or by [Name](#).
 This option is only available on digital channels and may not always be available.
- [Terrestrial](#), [Cable](#), or [Satellite](#)
Allows you to choose between [Terrestrial](#), [Cable](#), and [Satellite](#).
 This function may not be supported depending on the incoming broadcast signal.
 This function may not be supported depending on the model or geographical area.

Editing channels

Edit the channels stored on your TV.

 > [Live TV](#) > [Channel List](#) > [All](#) > [Edit Channels](#)

The [Edit Channels](#) screen icons indicate the following:

-  : A favourite channel
-  : A locked channel.
-  : CI card required channel.

On the [Edit Channels](#) screen, you can select channels and use the following functions:

- **Delete**

After selecting a target channel to remove in [Edit Channels](#), select [Delete](#). Removed channels are not displayed in the [Channel List](#).

- **Lock / Unlock**

After selecting a target channel in [Edit Channels](#), select [Lock](#) or [Unlock](#). Then the channel is locked or unlocked. A locked channel cannot be viewed.

 If you want to use this function or set the password, set  >  [Settings](#) > [Broadcasting](#) > [Apply Channel Lock to On](#).

 For more information about how to set your password, refer to "[Setting up a password](#)".

- **Rename channel**

After selecting a channel to change in [Edit Channels](#), select [Rename channel](#) to change the channel name.

 You can rename only one channel at a time.

 This function is only available for analogue broadcasts.

- **Change Number**

After selecting a channel to change in **Edit Channels**, select **Change Number** to change the channel number.

 This function may not be supported depending on the model or geographical area.

 When a channel number is changed, its channel information is not updated automatically.

- **Restore TV PLUS**

You can restore the deleted **Samsung TV Plus** channels.

 This function may not be supported depending on the model or geographical area.

- **Exit**

Closes the **Edit Channels** screen.

Using a Personal Favourites List

Designate frequently watched channels as favourite channels.

Favourite channels are highlighted in the [Edit Channels](#) and [Channel List](#) screens with the  symbol. You can create up to five favourites lists so that your family can create their own personal favourites list.

Viewing and selecting channels on Favourites list only

 > [Live TV](#) > [Channel List](#)



1. Press the right directional button on your remote control.
2. Select [Favourites](#).
3. Select the desired list among the five favourites lists on the screen.

The channels in the selected favourites list appear.

 If you select an empty favourites list, you are moved to the [Edit Favourites](#) screen.

Create a favourites list

 > [Live TV](#) > [Channel List](#) >  [Favourites](#) > [Favourites 1 - Favourites 5](#) > [Edit Favourites](#)

-  [\(Add to Favourites\)](#)
Selects one or more channels from a list of all channels to add to a favourites list.
-  [\(Remove from Favourites\)](#)
Removes one or more channels from a favourites list.
- [Change order](#)
Changes the order of one or more channels selected in a favourites list.
- [Rename Favourites](#)
Renames a favourites list.
- [Exit](#)
Closes the [Edit Favourites](#) screen.

TV-Viewing Support Functions

Use the functions that are supported by digital or analogue channels.

Changing the broadcast signal

 > [Live TV](#) > [Channel List](#)

Press the right directional button on your remote control, move the focus to [Terrestrial](#), [Cable](#), [Satellite](#), or [Service Provider](#) and then press the Select button.

 You do not need to use this function if your TV is connected to a cable box or satellite box.

 The displayed Channel List may vary depending on the incoming broadcast signals.

Scanning for available channels

 >  [Settings](#) > [Broadcasting](#) > [\(Auto Tuning Settings\)](#) > [Auto Tuning](#)

 This function may not be supported depending on the model or geographical area.

 If the TV is connected to a cable box or satellite box, you do not need to do this.

 The DVB-T2 system may not be supported depending on the geographical area.

 The [Auto Tuning Settings](#) may not appear depending on the model or geographical area.

Selecting the cable network search option

 >  [Settings](#) > [Broadcasting](#) > [\(Auto Tuning Settings\)](#) > [Cable Search Option](#)

Sets additional search options such as the frequency and symbol rate for a cable network search.

 This function may not be supported depending on the model or geographical area.

 The [Auto Tuning Settings](#) may not appear depending on the model or geographical area.

Scanning for available channels on standby mode

 >  [Settings](#) > [Broadcasting](#) > [\(Auto Tuning Settings\)](#) > [Standby Auto Tuning](#)

Automatically scan for channels while your TV is in standby mode.

 This function may not be supported depending on the model or geographical area.

 The [Auto Tuning Settings](#) may not appear depending on the model or geographical area.

Setting the Wake-up time

 >  [Settings](#) > [Broadcasting](#) > [\(Auto Tuning Settings\)](#) > [Wake-up Timer](#)

Schedule timer to turn the TV on and scan channels automatically.

 This function may not be supported depending on the model or geographical area.

 The [Auto Tuning Settings](#) may not appear depending on the model or geographical area.

Checking digital channel signal info and strength

 >  [Settings](#) > [Support](#) > [Self Diagnosis](#) > [Signal Information](#) Try Now

 If your TV is attached to a separate, over-the-air antenna, you can use the signal strength information to adjust the antenna for increased signal strength and improved HD channel reception.

 [Signal Information](#) is only available for digital channels.

 This function may not be supported depending on the model or geographical area.

Restricting Viewing to Specific Channels

 >  [Settings](#) > [Broadcasting](#) > [Apply Channel Lock](#) Try Now

By selecting the menu, you can turn on or off the [Apply Channel Lock](#) function.

Lock specific channels to prevent children from watching adult content.

 To use this function, the PIN number is required.

Using Mark Adult Channels

 >  [Settings](#) > [Broadcasting](#) > [Mark Adult Channels](#)

Enables or disables all adult services. When disabled, adult services will not be available.

 This function may not be supported depending on the model or geographical area.

Selecting the broadcasting audio option

 >  [Settings](#) > [Broadcasting](#) > [Dual Sound](#) Try Now

Set audio options for stereo or bilingual broadcasts. For more information, refer to "[Supported broadcasting audio options](#)".

 This function may not be supported depending on the model or geographical area.

Using Programme Rating Lock

 >  [Settings](#) > [Broadcasting](#) > [Programme Rating Lock](#) Try Now

 This function may not be supported depending on the model or geographical area.

This function is useful for controlling what programmes children can watch on the TV based on their ratings.

[Programme Rating Lock Settings](#) does not, however, block programmes originating from external sources, such as Blu-ray players, DVD players, or USB files.

Every time you access [Programme Rating Lock Settings](#), you must enter the security PIN. You must also enter this PIN to watch a blocked programme. The default PIN is "0000" (for France and Italy: "1111"). To change the PIN, go to

 >  [Settings](#) > [General](#) > [System Manager](#) > [Change PIN](#).

 For more information about how to set your password, refer to "[Setting up a password](#)".

 The [Broadcasting](#) is not available in HDMI or Component mode.

 [Programme Rating Lock](#) may not be supported depending on your input signal.

Showing common interface menu

 >  [Settings](#) > [Broadcasting](#) > [Common Interface](#)

You can view information about common interfaces.

 This function may not be supported depending on the model or geographical area.

- [CI Menu](#)

Enables the user to select from the CAM-provided menu. Select the CI menu based on the menu PC Card.

- [Application Info](#)

Displays information about the CAM inserted into the CI slot and about the “CI or CI+ CARD” inserted into the CAM. You can install the CAM any time, with or without the TV turned on.

- [CICAM PIN Manager](#)

Manages Common Interface Common Access Module (CICAM) PIN. Save PIN or change stored PIN and then set other PIN options.

 This function may not be supported depending on the model or geographical area.

- [Descramble Mode](#)

- [CAM video transcoding](#)

Configures the setting to transcode the video codec from the CAM automatically. Turn it Off if you do not want to use it.

 You must use a CAM that supports video codec transcoding.

Configuring advanced broadcasting settings

 >  [Settings](#) > [Broadcasting](#) > [Expert Settings](#) [Try Now](#)

Tuning broadcast signals manually

 >  [Settings](#) > [Broadcasting](#) > [Expert Settings](#) > [Manual Tuning](#) Try Now

You can scan for all the channels manually and store the scanned channels in the TV.

 This function may not be supported depending on the model or geographical area.

Tuning digital channels

 >  [Settings](#) > [Broadcasting](#) > [Expert Settings](#) > [Manual Tuning](#) > [Digital Channel Tuning](#)

Select [New](#), and then configure [Channel](#), [Frequency](#), and [Bandwidth](#), and then select [Search](#) to automatically scan and store a list of digital channels in the TV.

Tuning analogue channels

 >  [Settings](#) > [Broadcasting](#) > [Expert Settings](#) > [Manual Tuning](#) > [Analogue Channel Tuning](#)

Select [New](#) and configure [Programme](#), [Colour System](#), [Sound System](#), [Channel](#), and [Search](#) to scan for analogue channels. Then, select [Store](#) to store the scanned channels in the TV.

 This function is only available for analogue broadcasts.

Fine-tuning analogue broadcasts

 >  [Settings](#) > [Broadcasting](#) > [Expert Settings](#) > [Fine Tune](#) Try Now

 This function is only available for analogue broadcasts.

Transferring channel list

 >  [Settings](#) > [Broadcasting](#) > [Expert Settings](#) > [Transfer Channel List](#)

You can import or export the channel list to a USB storage. To use this function, the PIN number is required.

- [Import from USB](#): Imports channel list from a USB storage.
- [Export to USB](#): Exports channel list saved in the TV to a USB storage.

 This function is available when USB is connected.

 This function may not be supported depending on the model or geographical area.

Enabling/Disabling Edit Channel Numbers

 >  [Settings](#) > [Broadcasting](#) > [Expert Settings](#) > [Edit Channel Numbers](#)

Use this to change channel number. When channel number is changed, channel information is not updated automatically.

 This function may not be supported depending on the model or geographical area.

Deleting CAM operator profile

 >  [Settings](#) > [Broadcasting](#) > [Expert Settings](#) > [Delete CAM Operator Profile](#)

 This function may not be supported depending on the model or geographical area.

Setting satellite system

 >  [Settings](#) > [Broadcasting](#) > [Expert Settings](#) > [Satellite System](#)

You can configure a set of satellite dish settings before performing a channel scan.

 This function may not be supported depending on the model or geographical area.

Changing teletext language

 >  [Settings](#) > [Broadcasting](#) > [Expert Settings](#) > [Teletext Language Settings](#) > [Teletext Language](#)

You can set or change the teletext language. To watch the teletext broadcast in your preferred language, select a language to use in [Primary Teletext Language](#). If this language is not supported, you can watch the teletext broadcast in your secondary preferred language set in [Secondary Teletext Language](#).

 This function may not be supported depending on the model, channel or geographical area.

Selecting the broadcast audio language

 >  [Settings](#) > [Broadcasting](#) > [Expert Settings](#) > [Audio Options](#) Try Now

This is the language you will hear while watching TV if the language is included in the broadcast signal. [Audio Options](#) functions differently for analogue and digital channels.

 This function may not be supported depending on the model or geographical area.

- [Audio Language Settings](#)

You can change the audio language you want to hear.

 The available language may differ with the broadcast.

- [Audio Format](#)

You can change the audio format you want to hear.

 The supported audio format may differ with the broadcast programme.

 This option is only available on digital channels.

Showing TVkey Interface menu

 >  [Settings](#) > [Broadcasting](#) > [Expert Settings](#) > [TVkey Interface](#)

You can use the following functions:

- [TVkey Menu](#): Show TVkey Interface menu.
- [Guide](#): Select the guide you want to use when watching with TVkey.
- [Delete TVkey Operator Profile](#): Show the TVkey operator list to delete.

 This function may not be supported depending on the model or geographical area.

Reading digital text

 >  [Settings](#) > [Broadcasting](#) > [Expert Settings](#) > [Digital Text \(MHEG\)](#)

You can use this function when you watch a broadcast that includes both text and multimedia content.

 This function is only available in UK.

 Multimedia and Hypermedia Information Coding Experts Group (MHEG) is an International standard for data encoding systems used in multimedia and hypermedia. This is at a higher level than the MPEG system which includes data-linking hypermedia such as still images, character service, animation, graphic and video files as well as multimedia data. MHEG is user runtime interaction technology and is being applied to various fields including Video-On-Demand (VOD), Interactive TV (ITV), Electronic Commerce (EC), tele education, teleconferencing, digital libraries and network games.

Picture and Sound

You can change the settings for the picture and the sound according to your preference.

Using the Intelligent Mode

Let the TV analyse the surrounding and the content you are watching so that it can provide an upgraded viewing experience.

 >  **Settings** > **General** > **Intelligent Mode Settings**

In **Intelligent Mode**, the TV recognises and analyses the surroundings, the content, and your usage patterns to provide the best viewing experience. You can turn the options below on or off. Create your preferred viewing environment.

 Because this function is specific to QLED, THE FRAME and SERIF TVs, it may not be supported depending on the model.

- **Intelligent Mode**

Turn **Intelligent Mode** on or off.

- **Adaptive Brightness**

Automatically adjusts the backlight brightness of the screen by detecting the ambient light level using ambient light sensor.

 This function may not be supported by some modes or apps. (For example, **Ambient Mode**, and **Game Mode**)

- **Adaptive Sound**

Provides optimised sound quality by analysing the viewing environment and the acoustic components of the content.

- **Check TV Space**





Optimises the sound by analysing the space where the TV is installed. When the surroundings are quiet, point the Samsung Smart Remote at the front of the TV, and then start this function. This function is only available when the TV is paired with the Samsung Smart Remote.

 This function is only available when the sound output of the TV is set to **TV Speaker**.

 This function may not be supported by some modes or apps. (For example, **Ambient Mode**, **Game Mode**, and apps that control the TV sound)

- **Adaptive Volume**

Automatically adjusts to a specific volume level while you are watching TV. The TV analyses your volume usage history by time period to automatically adjust the volume when you use an app or switch to an external input source.

-  This function is only available when the sound output of the TV is set to **TV Speaker**.
-  This function may not be supported by some apps or external devices.
-  This function's operation affects **Auto Volume** function, but it does not work the other way around.
-  This function operates based on your volume usage history, and may not operate if the volume usage history by time period is insufficient.
-  The amount of difference made by this function does not exceed +/- 5 levels from the current volume, and this function does not change the current volume if it exceeds 40.

Adjusting the Picture Quality

Change the Picture Mode and adjust Expert Settings.

Choosing a picture mode

 >  **Settings** > **Picture** > **Picture Mode** 

You can select the **Picture Mode** that provides the best viewing experience.

- **Dynamic**
Makes the picture brighter and clearer in bright viewing environments.
- **Standard**
Is the default mode suitable for general viewing environments.
- **Natural**
Reduces eye strain for a comfortable viewing experience.
- **Movie**
Is suitable for watching TV or movies in a dark room.

 This function may not be supported depending on the model.

Configuring advanced picture settings

 >  [Settings](#) > [Picture](#) > [Expert Settings](#) [Try Now](#)

Configure the screen settings to your taste by using the following functions:

- [Backlight](#) [Try Now](#)
- [Brightness](#) [Try Now](#)
- [Contrast](#) [Try Now](#)
- [Sharpness](#) [Try Now](#)
- [Colour](#) [Try Now](#)
- [Tint \(G/R\)](#) [Try Now](#)
- [Apply Picture Settings](#) [Try Now](#)
- [Digital Clean View](#) [Try Now](#)
- [Auto Motion Plus Settings](#) [Try Now](#)



When **LED Clear Motion** is set to **On**, the screen appears darker than when it is **Off**.

- [Local Dimming](#)



Controls the brightness of individual areas on the screen to maximise contrast automatically.



This function may not be supported depending on the model or geographical area.

- [Contrast Enhancer](#) [Try Now](#)

- [Film Mode](#) [Try Now](#)



This function is only available when the input signal is TV, AV, Component (480i, 576i, 1080i), or HDMI (1080i).

- [Colour Tone](#) [Try Now](#)
- [White Balance](#) [Try Now](#)
- [Gamma](#) [Try Now](#)
- [RGB Only Mode](#) [Try Now](#)
- [Colour Space Settings](#) [Try Now](#)
- [Reset Picture](#) [Try Now](#)

Setting the Viewing Environment for External Devices







You can optimise the TV for viewing specific video formats.

Playing games on an optimised screen



> [Settings](#) > [General](#) > [External Device Manager](#) > [\(Game Mode Settings\)](#) > [Game Mode](#)

You can enable the game mode to optimise the TV's settings for playing video games with a gaming console, such as a PlayStation™, Xbox™ or Nintendo Switch™.

-  The [Game Mode Settings](#) may not appear depending on the model or geographical area.
-  The game mode is not available for normal TV viewing.
-  The screen may shake somewhat.
-  When [Game Mode](#) is enabled, [Picture Mode](#) and [Sound Mode](#) are switched to [Game](#) automatically. [Sound Mode](#) may not be automatically switched depending on the selected audio device on the [Sound Output](#) menu.
-  When [Game Mode](#) is set to [On](#), some functions are not available.
-  To use other external device on the same port, remove the game console connection, set [Game Mode](#) to [Off](#), and then connect the external device to the port.
-  The [Game Mode](#) functions used for Nintendo Switch™ are subject to change without prior notice.

Setting the Game Mode details

 >  [Settings](#) > [General](#) > [External Device Manager](#) > [Game Mode Settings](#)

 These functions may not be supported depending on the model.

- [Game Enhancer](#)

You can make your games more immersive by using intense, vivid picture quality and three-dimensional sound optimised for games.

- [Dynamic Black Equalizer](#)

You can easily detect items or hidden enemies lurking in dark corners by improving visibility and object details in dark scenes without washing out colours and contrast in brighter scenes.

- [Game Motion Plus Settings](#)

You can configure the Game Motion Plus settings.

- [FreeSync](#)

You can make your gaming experience more pleasant by eliminating screen tearing and stuttering.

- Be sure to set this function only for the external devices that support the AMD Radeon FreeSync feature.
- For an optimised game environment, set the resolution of the external device to 1080p at 120 Hz. For more information, refer to "[Supported Resolutions for FreeSync](#)".

 If the resolution is not supported, the operation may not be smooth.

 When the FreeSync options are set or the FreeSync function is operating for an external device, the screen may flicker.





 Slight brightness changes may occur during FreeSync operation due to frequency variation of the external device.

 Before playing a game, set [FreeSync](#) to [Basic](#) or [Ultimate](#).

Using Input Signal Plus

 >  **Settings** > **General** > **External Device Manager** > **Input Signal Plus** [Try Now](#)

Expands the input signal range for HDMI connections.

-  If you move to the HDMI connector with which you want to use the **Input Signal Plus** function and press the Select button to set the function to **On**, the TV screen may flicker.
-  When you connect the TV to an external device that supports only the UHD 24 or 30 Hz frequencies or any FHD frequency, the **Input Signal Plus** function may not be available. In this case, turn off the **Input Signal Plus** function.
-  For more information about the supported UHD resolutions, refer to "[Supported Resolutions for UHD Input Signals](#)".
-  For more information about the Q900RB model series, refer to "[Resolutions for Input Signals supported by Q900RB model series](#)".

Using HDMI black level

 >  **Settings** > **General** > **External Device Manager** > **HDMI Black Level** [Try Now](#)

Use HDMI Black Level to adjust the black level to compensate for low black levels, low contrast, or dull colours generated by external devices connected to the TV via an HDMI cable.

-  This function is only available when the input signal, connected to the TV via an HDMI connector, is set to RGB444.





Picture Support Functions

Configure the picture settings for your TV.

Viewing a picture-in-picture (PIP)

 >  [Settings](#) > [Picture](#) > [PIP](#)

While viewing video from an external device such as a Blu-ray player on the main screen, you can watch a TV broadcast in a picture-in-picture (PIP) window.

-  This function may not be supported depending on the model or geographical area.
-  PIP is not available while Smart Hub is active.
-  Playing a game or using the karaoke function on the main screen can result in lower PIP picture quality.
-  The PIP function is only available under the following conditions: 1) The main screen's source is a Component or HDMI connection. 2) The input resolution is less than FHD (Full HD).
-  The PIP window supports digital channels only and does not support UHD channels.

Changing the picture size

 >  [Settings](#) > [Picture](#) > [Picture Size Settings](#) > [Picture Size](#) [Try Now](#)

You can change the size of the picture displayed on the TV screen to **16:9 Standard**, **Custom**, or **4:3**.

-  Supported picture sizes differ with the input signal. For more information about supported picture sizes, refer to "[Picture sizes and input signals](#)".

Changing the picture size automatically

 >  [Settings](#) > [Picture](#) > [Picture Size Settings](#) > [Auto Wide](#)

 This function may not be supported depending on the model or geographical area.

Changing the picture size in 4:3 or Screen Fit mode

 >  [Settings](#) > [Picture](#) > [Picture Size Settings](#) > [4:3 Screen Size](#)

You can select a picture size suitable for your geographical area while you are watching TV in the [4:3](#) or [Fit to screen](#) mode. The supported screen sizes differ with the country and this function allows you to adjust the picture size in this case.

 The [4:3](#) mode is not available when an external device is connected to the TV via a Component connector or an HDMI connector.

 This function may not be supported depending on the model or geographical area.

Fitting the picture to the screen

 >  [Settings](#) > [Picture](#) > [Picture Size Settings](#) > [Fit to screen](#) [Try Now](#)

 This function may not be supported depending on the [Picture Size](#) setting.

 This function may not be supported depending on broadcasting signals.

Adjusting the picture size and/or position

 >  [Settings](#) > [Picture](#) > [Picture Size Settings](#) > [Zoom and Position](#) [Try Now](#)

 This function is available only if [Picture Size](#) is set to [Custom](#).

 To change the picture position on analogue channels, first enlarge the picture and then change the position.

Configuring a Sound Mode and Expert Settings

Change the Sound Mode and adjust Expert Settings.

Choosing a sound mode

 >  **Settings** > **Sound** > **Sound Mode** [Try Now](#)

You can select the available sound mode - **Standard** or **Amplify** - that you prefer for a content type or your listening environment.

 This function may not be supported depending on the model.

 When an external device is connected, **Sound Mode** may change accordingly.

Configuring advanced sound settings

 >  **Settings** > **Sound** > **Expert Settings** [Try Now](#)

You can personalise the sound quality by adjusting the following settings.

- **Balance** [Try Now](#)

- **Equaliser** [Try Now](#)

 This function is not available when the **Adaptive Sound** function is turned on.

 The name of this function display may appear differently depending on the connected external device.

- **Digital Output Audio Format** [Try Now](#)

To play Dolby Digital+ (with Atmos) content, select **Dolby Digital+**.

 The **Dolby Digital+** option is only available via HDMI (ARC) for external devices that support the format.

 If you use a AV receiver that does not support Dolby Digital+, you will hear no sound if you select **Dolby Digital+**.

- **Digital Output Audio Delay** [Try Now](#)

 This function is only available when the external device is connected with an SPDIF (Sony Philips Digital Interface) cable.

- **Dolby Atmos Input** [Try Now](#)

You can set the TV to allow Dolby Digital+ with Atmos streams that are inputted from external devices.

Set to **On** if the audio device connected via HDMI (ARC) supports Dolby Atmos. The TV screen may flicker when this function is turned on or off.

 If this function is on, set **Digital Output Audio Format** to **Dolby Digital+**.

- [Auto Volume](#) [Try Now](#)
- [Sound Feedback](#) [Try Now](#)
- [Reset Sound](#) [Try Now](#)

 Standard audio signals are sampled at 48 kHz while HD audio signals are sampled at 96 kHz.

 Some SPDIF receivers may not be compatible with HD audio format.

Using the Sound Support Functions

Configure the sound settings for your TV.

Selecting speakers

 >  [Settings](#) > [Sound](#) > [Sound Output](#) [Try Now](#)

You can select which speakers the TV uses for audio output.

 External speakers may not be controlled with the Samsung Smart Remote. When an external speaker is enabled, some sound menus are not supported.

Listening to the TV through Bluetooth devices

 >  [Settings](#) > [Sound](#) > [Sound Output](#) > [Bluetooth Speaker List](#)

You can connect Bluetooth audio devices to the TV. They must be paired using the TV's Bluetooth function. For more information on pairing, refer to the Bluetooth audio device's operating manual.

 This function may not be supported depending on the model or geographical area.

 If the TV fails to find a Bluetooth audio device, place the device closer to the TV, and then select [Refresh](#).

 When you turn on a paired Bluetooth audio device, the TV detects it automatically, and then displays a pop-up window. Use this pop-up window to activate/deactivate the Bluetooth audio device.

 The sound quality may be affected by the condition of the Bluetooth connection.

 Before using a Bluetooth audio device, refer to "[Read Before Using Bluetooth Devices](#)".

Listening to the TV through a Samsung audio device that supports the Wi-Fi function





For more information about how to connect and use a Samsung audio device that supports the Wi-Fi function, refer to its user manual.

 >  **Settings** > **Sound** > **Wi-Fi Speaker Surround Setup** 

If you've connected one or more Samsung wireless audio devices that support the Wi-Fi function to the TV, you can create an optimal sound set up by configuring the surround effect settings. You can select any of the surround sound configurations, with or without a sound bar.

A surround sound configuration can be used if all of the following conditions are met:

- Two or more Samsung wireless speakers of the same type must be connected to the same wireless network.
- The Samsung audio devices that supports the Wi-Fi function, must be connected to the same wireless network as the TV.

-  The surround sound configurations with a sound bar may not be supported depending on the product.
-  If you activate the Screen Mirroring function while using the Samsung audio devices that supports the Wi-Fi function, the connection is disconnected.
-  Lip syncs with mismatched video and audio time codes may occur depending on the device type.
-  This function may not be supported depending on the model or geographical area.

System and Support

You can configure system and support settings such as clock, timers, energy usage and software updates.

Using the Time Functions and the Timers

Set the current time and use the timer function.

 >  **Settings** > **General** > **System Manager** > **Time** 



You can set the **Clock** manually or automatically. Once the **Clock** is set, you can view the current time on the TV anytime.

You must set the clock in the following cases:

- The power cable is disconnected and then connected.
- The **Clock Mode** is changed from **Auto** to **Manual**.
- The TV is not connected to the Internet.
- No broadcast signals are received.

Setting the clock automatically

 >  **Settings** > **General** > **System Manager** > **Time** > **Clock** > **Clock Mode** > **Auto**

-  This function works only when the TV is connected to the Internet or is receiving digital broadcasts through an antenna connected.
-  The accuracy of the time information received may differ with the channel and signal.
-  When watching TV by connecting a cable box or satellite box to the HDMI or Component port, you must set the current time manually.

Setting the clock manually



 >  [Settings](#) > [General](#) > [System Manager](#) > [Time](#) > [Clock](#) > [Clock Mode](#) > [Manual](#)

When [Clock Mode](#) is set to [Manual](#), you can directly enter the current time. Select the [Date](#) and [Time](#) by using the arrow buttons on the remote control.

Adjusting the clock for DST and time zone

 >  [Settings](#) > [General](#) > [System Manager](#) > [Time](#) > [Clock](#) > [Time Zone](#)

Sets the right time by setting Daylight Savings Time (DST) and your local time zone.

-  This function is only available when the [Clock Mode](#) is set to [Auto](#).
-  This function may not be supported depending on the model or geographical area.

- [GMT](#)
Selects your time zone.
- [DST](#)
Automatically adjust for Daylight Saving Time (DST).

Changing the current time

 >  [Settings](#) > [General](#) > [System Manager](#) > [Time](#) > [Clock](#) > [Time Offset](#)

[Time Offset](#) adjusts the time through a network connection.

 This function is available only when [Clock Mode](#) is set to [Auto](#), the TV fails to receive time information through normal broadcast signals, and the TV is connected to the Internet through a local area network.

Using the sleep timer

 >  [Settings](#) > [General](#) > [System Manager](#) > [Time](#) > [Sleep Timer](#)

You can use this function to automatically shut off the TV after a pre-set period of time. You can set the sleep timer to up to 180 minutes to automatically turn off the TV.

 This function may not be supported depending on the model or geographical area.

Turning off the TV using the off timer

 >  [Settings](#) > [General](#) > [System Manager](#) > [Time](#) > [Off Timer](#)

You can set [Off Timer](#) to shut off the TV automatically at a specific time. [Off Timer](#) is only available if the [Clock](#) has been set.

 To use this function, first set the [Clock](#) ( >  [Settings](#) > [General](#) > [System Manager](#) > [Time](#) > [Clock](#)).

Using the Auto Protection Time and Energy Saving Functions

Set the Auto Protection Time and reduce the TV's energy consumption.

Setting the Auto Protection Time

 >  [Settings](#) > [General](#) > [System Manager](#) > [Auto Protection Time](#) [Try Now](#)

Activate a screensaver when your TV displays a still image for two hours or more.

 This function may not be supported in some viewing modes.

 This function may not be supported depending on the model or geographical area.

Reducing the energy consumption of the TV



 >  [Settings](#) > [General](#) > [Eco Solution](#) [Try Now](#)

You can adjust the brightness level of the TV, reduce overall power consumption, and prevent overheating.

- [Ambient Light Detection](#) [Try Now](#)

Automatically adjusts the brightness level of the TV, according to the ambient light level, to reduce power consumption. If the [Ambient Light Detection](#) has adjusted the screen brightness to a too bright or dark level, you can select [Minimum Backlight](#) to manually adjust the minimum screen brightness.

- [Minimum Backlight](#) [Try Now](#)

When the [Ambient Light Detection](#) is turned on, you can manually adjust the minimum brightness of the TV screen. This function acts only when the value is less than the setting in  >  [Settings](#) > [Picture](#) > [Expert Settings](#) > [Backlight](#).

 This function is not available when the [Adaptive Brightness](#) function is turned on.

- [Energy Saving Mode](#) [Try Now](#)

Adjust the brightness settings to reduce the TV's power consumption.

 This function is not available when the [Adaptive Brightness](#) function is turned on.

- [Motion Lighting](#) [Try Now](#)

Adjusts the brightness in response to on-screen movements to reduce power consumption.

- [Auto Power Off](#) [Try Now](#)

Automatically turns off the TV to reduce unnecessary power consumption if the TV Controller and the remote control are not used for the set period of time.

Updating the TV's Software

View your TV's software version and update it if necessary.

⚠ DO NOT turn off the TV's power until the update is complete. The TV will turn off and on automatically after completing the software update. Video and audio settings will be reset to their defaults after a software update.

 >  [Settings](#) > [Support](#) > [Software Update](#) 

Updating through the Internet

 >  [Settings](#) > [Support](#) > [Software Update](#) > [Update Now](#) 

 Updating from the Internet requires an active Internet connection.

Updating through a USB device

 >  [Settings](#) > [Support](#) > [Software Update](#) > [Update Now](#)

After downloading the update file from the Samsung website and storing it on a USB device, connect the USB device to the TV to update.

 To update using a USB device, download the update package from Samsung.com to your computer. Then, save the update package in the USB device's top-level folder. Otherwise, the TV will not be able to locate the update package.

Updating the TV automatically

 >  [Settings](#) > [Support](#) > [Software Update](#) > [Auto update](#) 

If the TV is connected to the Internet, you can have the TV update its software automatically while you are watching the TV. When the background update is completed, it is applied the next time the TV is turned on.

If you agree to the Smart Hub terms and conditions, [Auto update](#) is set to **On** automatically. If you want this function disabled, use the Select button to turn it off.

 This function may take a longer time if another network function is running concurrently.

 This function requires an Internet connection.

Protecting the TV from Hacking and Malicious Code

Protect your TV from hacking attempts and malicious code.

 >  [Settings](#) > [General](#) > [System Manager](#) > [Smart Security](#) Try Now

You can use [Smart Security](#) to protect the TV from hacking and malicious code when it is connected to the Internet.

Scanning the TV and connected storage for malicious code

 >  [Settings](#) > [General](#) > [System Manager](#) > [Smart Security](#) > [Scan](#)

If malicious code is found, the results of the scan will appear on the screen. This result window displays all malicious code found. You can quarantine (isolate) the code. Quarantining prevents it from executing.

1. Select all the malicious code to quarantine.
2. Select [Isolate](#).

The selected malicious code is relocated to the [Isolated List](#).

 The [Isolated List](#) displays all quarantined malicious codes.

Audio and Video Functions for the Visually or Hearing Impaired



You can configure the functions for the visually or hearing impaired.

Running the accessibility functions

 >  **Settings** > **General** > **Accessibility** [Try Now](#)

Running Accessibility Shortcuts

The **Accessibility Shortcuts** provide access to the accessibility functions. To display the **Accessibility Shortcuts**, press and hold the Volume button for 1 second or more. You can easily turn on or turn off the functions such as **Voice Guide**, **Audio Description**, **Subtitle**, **High Contrast**, **Enlarge**, **Greyscale**, **Colour Inversion**, **Learn TV Remote**, **Menu Learning Screen**, **Multi-output Audio**, **Sign Language Zoom**, **Slow Button Repeat**, etc.



-  On the standard remote control, press the AD/SUBT. button or press and hold MUTE button.
-  Even if the **Voice Guide** is set to **Off** or muted, the voice guide for **Accessibility Shortcuts** is enabled.
-  The shortcut menus may not appear depending on the model or geographical area.

Enabling voice guides for the visually impaired

 >  **Settings** > **General** > **Accessibility** > **Voice Guide Settings** [Try Now](#)

You can activate voice guides that describe the menu options aloud to aid the visually impaired. To activate this function, set **Voice Guide** to **On**. With **Voice Guide** on, the TV provides voice guides for channel change, volume adjust, information on current and upcoming programmes, schedule viewing, other TV functions, various content in the **Internet**, and in **Search**.

You can go to **Voice Guide** and press the Select button to turn the function on or off.

-  The **Voice Guide** is provided in the language that is specified on the TV **Language**. However, some languages are not supported by **Voice Guide** even though they are listed in the TV **Language**. **English** is always supported.
-  For more information about the TV **Language** settings, refer to "[Changing the menu language](#)".

Changing the volume, speed, and pitch of the Voice Guide

You can configure the volume, speed, and pitch of the voice guide.

Audio Description

 >  [Settings](#) > [General](#) > [Accessibility](#) > [Audio Description Settings](#) Try Now

You can activate an audio guide that provides an audio description of video scenes for the visually impaired. This function is only available with broadcasts that provide this service.

 This function is only available on digital channels.

- [Audio Description](#)
Turns the audio description function on or off.
- [Audio Description Volume](#)
Adjusts the audio description volume.

White text on black background (high contrast)

 >  [Settings](#) > [General](#) > [Accessibility](#) > [High Contrast](#) Try Now

You can change Smart Hub and setting menu screens to white text on a black background and change the transparent TV menus to opaque automatically so that text can be more easily read.

 If [High Contrast](#) is on, some [Accessibility](#) menus are not available.

Setting the screen to a black and white tone

 >  [Settings](#) > [General](#) > [Accessibility](#) > [Greyscale](#) Try Now

You can change the colour of the TV screen to a black and white tone to sharpen blurred edges caused by colours.

 If [Greyscale](#) is on, some [Accessibility](#) menus are not available.

 This function may not be supported depending on the model or geographical area.

Inverting the screen colour

 >  [Settings](#) > [General](#) > [Accessibility](#) > [Colour Inversion](#) Try Now

You can invert the colours of the text and background for the setting menus displayed on the TV screen to make it easier to read them.

 If [Colour Inversion](#) is on, some [Accessibility](#) menus are not available.

 This function may not be supported depending on the model or geographical area.

Enlarging the font (for the visually impaired)

 >  [Settings](#) > [General](#) > [Accessibility](#) > [Enlarge](#) Try Now

You can enlarge the size of the font on the screen. To activate this function, set [Enlarge](#) to [On](#).

Learning about the remote control (for the visually impaired)

 >  [Settings](#) > [General](#) > [Accessibility](#) > [Learn TV Remote](#) Try Now

This function helps individuals with a visual impairment to learn the positions of the buttons on the remote control. When this function is activated, you can press a button on the remote control and the TV will tell you its name. Press the  button twice to exit [Learn TV Remote](#).

 This function is only available when [Voice Guide](#) is enabled.

Learning about the TV menu

 >  [Settings](#) > [General](#) > [Accessibility](#) > [Menu Learning Screen](#) Try Now



Learn the menus on the TV screen. Once enabled, your TV will tell you the structure and features of the menus you select.

 This function is only available when [Voice Guide](#) is enabled.

Watching TV broadcasts with subtitles

 >  [Settings](#) > [General](#) > [Accessibility](#) > [Subtitle Settings](#) Try Now

Set **Subtitle** to **On**. Then you can watch the programme with the subtitle displayed.

-  This function may not be supported depending on the model or geographical area.
-  This function has no relationship with the features for controlling sub-titles of DVD or Blu-ray players. To control DVD or Blu-ray subtitles, use the sub-title feature of the DVD or Blu-ray player and the player's remote control.

- [Subtitle](#)
Turns on or off the subtitle.
- [Subtitle Mode](#)
Sets the subtitle mode.
- [Subtitle Language](#)
Sets the subtitle language.

Selecting the broadcasting subtitle language



You can select the default subtitle language. The list may vary depending on the broadcast.

- [Primary Subtitle Language](#)
Sets the primary subtitle language.
- [Secondary Subtitle Language](#)
Sets the secondary subtitle language.

Listening to the TV through Bluetooth devices (for the hearing impaired)

 >  [Settings](#) > [General](#) > [Accessibility](#) > [Multi-output Audio](#)

You can turn on both the TV speaker and Bluetooth headphone at the same time. When this function is active, you can set the volume of the Bluetooth headphone higher than the volume of the TV speaker.

-  This function may not be supported depending on the model or geographical area.
-  When you connect the Bluetooth headphone to the TV, [Multi-output Audio](#) is activated. For more information about connecting Bluetooth devices to the TV, refer to "[Listening to the TV through Bluetooth devices](#)".

Enlarging the sign language screen for the hearing impaired

 >  [Settings](#) > [General](#) > [Accessibility](#) > [Sign Language Zoom Settings](#) Try Now

You can zoom in the sign language screen when the programme you are watching provides it. First, set [Sign Language Zoom](#) to [On](#), and then select [Edit Sign Language Zoom](#) to change the position and magnification of the sign language screen.

Configuring the repeat settings for remote control buttons

 >  [Settings](#) > [General](#) > [Accessibility](#) > [Remote Button Repeat Settings](#) Try Now

You can configure the operation speed of the remote control buttons so that they slow down when you continually press and hold them. First, set [Slow Button Repeat](#) to [On](#), and then adjust the operation speed in [Repeat Interval](#).

Using Other Functions

You can view other functions.

Changing the menu language

 >  [Settings](#) > [General](#) > [System Manager](#) > [Language](#) Try Now

Setting up a password

 >  [Settings](#) > [General](#) > [System Manager](#) > [Change PIN](#) Try Now

The PIN input window appears. Enter a PIN. Enter it again to confirm it. The default PIN is "0000" (for France and Italy: "1111").

 If you forget your PIN, you can reset it with your remote control. With the TV turned on, press the following buttons on the remote control in the order shown to reset the PIN to "0000" (for France and Italy: "1111").

On the Samsung Smart Remote: Select VOL button. > Volume Up >  > Volume Down >  > Volume Up > .

On the standard remote control: Select  button. > (+) (Volume Up) > Select RETURN button. > (—) (Volume Down) > Select RETURN button. > (+) (Volume Up) > Select RETURN button.

Selecting Usage or Retail Mode

 >  **Settings** > **General** > **System Manager** > **Usage Mode** Try Now

You can set the TV for retail environments by setting **Usage Mode** to **Retail Mode**.

 For all other uses, select **Home Mode**.

 Use **Retail Mode** only in a store. With **Retail Mode**, some functions are disabled, and the TV settings automatically reset after a preset amount of time.

Managing External Devices

 >  **Settings** > **General** > **External Device Manager** > **Device Connection Manager** Try Now

When you connect external devices such as mobile devices or tablets connected to the same network as the TV so you can share content, you can view the list of allowed devices and connected devices.

- **Access Notification**

Set whether to display a notification when an external device such as a mobile device or tablet attempts to connect to the TV.

- **Device List**

Manage a list of external devices registered to the TV.

Using AirPlay

 >  **Settings** > **General** > **Apple AirPlay Settings**



You can use AirPlay to view content from your iPhone, iPad, or Mac on the TV screen.

Restoring the TV to the factory settings

 >  **Settings** > **General** > **Reset** Try Now

You can restore all TV settings to the factory defaults.

1. Select **Reset**. The security PIN entry window appears.
2. Enter the security PIN, and then select **Yes**. All settings are then reset. The TV turns off and on again automatically and displays the Initial Setup screen.

 If you skipped some steps in the initial setup, run **Set Up TV** ( >  **Source** > up directional button > **TV** > up directional button > **Set Up TV**), and then configure the settings in the steps you skipped.

 For more information on **Reset**, refer to the user manual that came with the TV.

HbbTV

Access services from entertainment providers, online providers and CE manufactures through HbbTV.

 This function may not be supported depending on the model or geographical area.

 Some channels may not include the HbbTV service.

In some countries, **HbbTV** is disabled by default. In this case, HbbTV can be used by installing the HbbTV application (the HbbTV Installer Application) from Samsung [APPS](#).





To set the HbbTV automatic start to on or off, access  >  [Settings](#) > [Broadcasting](#) > [Expert Settings](#) > [HbbTV Settings](#) and set **HbbTV** to on or off. (Depending on the geographical area.)

You can use the following functions:

- **HbbTV**: Enable or disable data services.
- **Do Not Track**: Ask apps and services not to track your browsing activity.
- **Private Browsing**: Enable Private Browsing to stop the browser from saving your Internet history.
- **Delete Browsing Data**: Delete all saved Cookies.

If you want this function enabled or disabled, use the Select button to turn it on or off.



- HbbTV is not available when Timeshift is running or when a recorded video is being played back.
- An application on HbbTV may malfunction temporarily depending on the circumstances of the broadcast station or application provider.
- An application on HbbTV usually operates only when the TV is connected to an external network. The application may malfunction depending on the network conditions.
- When the HbbTV application is installed and the broadcasting programme supports HbbTV, a red button appears on the screen.
- It is possible to use both Digital Teletext and Traditional Teletext in several limited channels by pressing the TTX/MIX button on the remote control in a toggling manner.

 With the Samsung Smart Remote, long press the  or  button for over 1 second or press the  or  button and then select **TTX/MIX** on the pop-up list.

- When you press the TTX/MIX button once in HbbTV mode, digital TTX mode of HbbTV is activated.
- When you press the TTX/MIX button twice in HbbTV mode, Traditional Teletext mode is activated.

Using a TV Viewing Card (“CI or CI+ Card”)

Watches paid channels by inserting your TV Viewing Card (“CI or CI+ Card”) into the COMMON INTERFACE slot.

-  The 2 CI card slots may not be supported depending on the model.
-  Turn the TV off to connect or disconnect a “CI or CI+ Card”.
-  The “CI or CI+ Card” may not supported depending on the model.

Connecting the “CI or CI+ Card” via COMMON INTERFACE slot with the CI CARD Adapter

-  Only for models with Common interface slot.

Attaching the CI CARD Adapter via COMMON INTERFACE slot

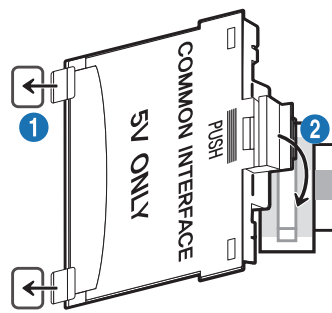

To attach the CI CARD Adapter to the TV, follow these steps:

- 1** Insert the CI CARD Adapter into the two holes on the back of TV.
 -  Please locate the two holes at the back of the TV above the COMMON INTERFACE slot.
- 2** Connect the CI CARD Adapter to the COMMON INTERFACE slot on the back of TV.

Connecting the “CI or CI+ Card”

Connect the “CI or CI+ Card” to the COMMON INTERFACE slot as shown in the image below.

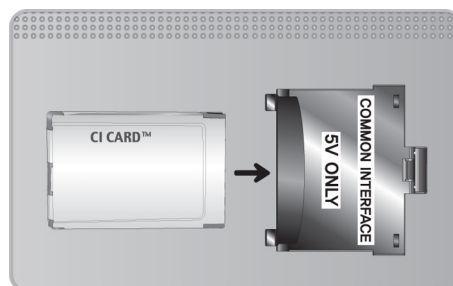

Connecting the “CI or CI+ Card” via COMMON INTERFACE slot

 Only for models with Common interface slot.

Connect the “CI or CI+ Card” to the COMMON INTERFACE slot as shown in the image below.

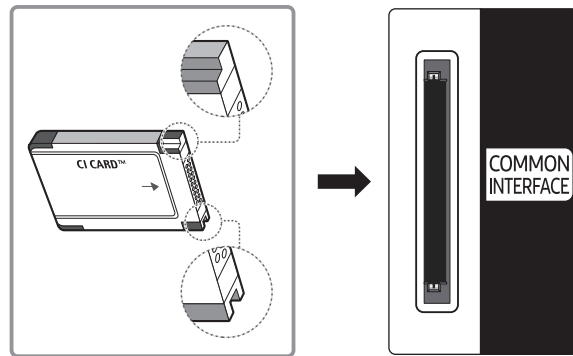

Using the “CI or CI+ Card”

To watch paid channels, the “CI or CI+ CARD” must be inserted.

- Samsung TV follow up CI+ 1.4 standard. When Samsung TV display the pop-up message, it may happen due to CI+ 1.4 Version inconsistency. If you have a problem, please contact Samsung Call Centre.

 Your Samsung TV conforms to the CI+ 1.4 standards.

 Where a CI+ Common Interface module is incompatible with Samsung TV then please remove the module and contact the CI+ operator for assistance.

- If you don't insert the “CI or CI+ CARD”, some channels will display the pop-up message.
- The pairing information will be displayed in about 2-3 minutes. If an error message is displayed, please contact your service provider.
- When the configuration of channel information has finished, the message “Updating Completed” is displayed, indicating the channel list is updated.

 You must obtain a “CI or CI+ CARD” from a local cable service provider.

 When removing the “CI or CI+ CARD”, carefully pull it out with your hands since dropping the “CI or CI+ CARD” may cause damage to it.

 Insert the “CI or CI+ CARD” in the direction marked on the card.

 The location of the COMMON INTERFACE slot may be different depending on the model.









 “CI or CI+ CARD” is not supported in some countries and regions. Check with an authorised dealer to find out if “CI or CI+ CARD” is supported in your locality.

 If you have any problems, please contact a service provider.

 Insert the “CI or CI+ CARD” that supports the current aerial settings. If not, the screen may not look normal.

Teletext Feature

Learn how to use Teletext and run the functions provided by Teletext Service.

-  This function is available only in the channel that supports the teletext service.
-  This function may not be supported depending on the model or geographical area.
-  To enter the Teletext feature,
 - On the Samsung Smart Remote: Press the  or  button and then select **TTX/MIX** on the pop-up list.
 - On the standard remote control: Press the  TTX/MIX button.
-  To exit from the Teletext feature,
 - On the Samsung Smart Remote: Press the **TTX/MIX** button on the pop-up list until a live TV programme appears.
 - On the standard remote control: Press the  TTX/MIX button on the remote control until live TV appears.

The index page of the Teletext service gives you information on how to use the Service. For Teletext information to be displayed correctly, channel reception must be stable. Otherwise, information may be missing or some pages may not be displayed.

-  You can change Teletext pages by select numeric using your remote control.

On the Samsung Smart Remote



TTX/MIX (Full TTX / Double TTX / Mix / Live TV): The teletext mode is activated in the channel that is being watched. Each time you press the TTX/MIX button, the teletext mode changes in the order of **Full TTX → Double TTX → Mix → Live TV**.

- **Full TTX:** The teletext mode appears on the full screen.
- **Double TTX:** The teletext mode appears on the half screen along with the currently viewed channel on the other half.
- **Mix:** The teletext mode appears transparently on the currently viewed channel.
- **Live TV:** It returns to the live TV screen.

Colour buttons (red, green, yellow, blue): If the FASTEXT system is used by the broadcasting company, the different topics on a Teletext page are colour-coded and can be selected by coloured buttons. Press the colour corresponding to the topic of your choice. A new colour coded page appears. Items can be selected in the same way. To display the previous or next page, select corresponding coloured button.

 **Index:** Displays the index (contents) page at any time while you are viewing Teletext.

 **Sub Page:** Displays the available sub-page.

 **List/Flof:** Selects the Teletext mode. If pressed during LIST mode, switches the mode to List save mode. In List save mode, you can save a Teletext page into a list using the  (Store) button.

 **Store:** Stores the Teletext pages.

 **Page Up:** Displays the next Teletext page.

 **Page Down:** Displays the previous Teletext page.

 **Reveal/Conceal:** Displays or hides the hidden text (answers to quiz games, for example). To display the normal screen, press it again.

 **Size:** Displays the teletext on the upper half of the screen in double-size. To move the text to the lower half of the screen, press it again. For normal display, press it once again.

 **Hold:** Holds the display at the current page, in the case that there are several secondary pages that follow automatically. To undo, press it again.

 **Cancel:** Shrinks the Teletext display to overlap with the current broadcast. To undo, press it again.

On the standard remote control

 On the standard remote control, the Teletext function icons are printed on some remote control buttons. To run a Teletext function, find its icon printed on a remote control button, and then press the found button.

 TTX/MIX

Full TTX / Double TTX / Mix / Live TV: The teletext mode is activated in the channel that is being watched. Each time you press the  TTX/MIX button, the teletext mode changes in the order of **Full TTX** → **Double TTX** → **Mix** → **Live TV**.

- **Full TTX:** The teletext mode appears on the full screen.
- **Double TTX:** The teletext mode appears on the half screen along with the currently viewed channel on the other half.
- **Mix:** The teletext mode appears transparently on the currently viewed channel.
- **Live TV:** It returns to the live TV screen.

Colour buttons (red, green, yellow, blue): If the FASTEXT system is used by the broadcasting company, the different topics on a Teletext page are colour-coded and can be selected by coloured buttons. Press the colour corresponding to the topic of your choice. A new colour coded page appears. Items can be selected in the same way. To display the previous or next page, select corresponding coloured button.

 SETTINGS

Index: Displays the index (contents) page at any time while you are viewing Teletext.

 PRE-CH

Sub Page: Displays the available sub-page.

 SOURCE

List/Flof: Selects the Teletext mode. If pressed during LIST mode, switches the mode to List save mode. In List save mode, you can save a Teletext page into a list using the  (Store) button.

 CH LIST

Store: Stores the Teletext pages.

 CH ^

Page Up: Displays the next Teletext page.

 CH v

Page Down: Displays the previous Teletext page.

INFO

Reveal/Conceal: Displays or hides the hidden text (answers to quiz games, for example). To display the normal screen, press it again.

AD/SUBT.

 Depending on the model or geographical area.

Size: Displays the teletext on the upper half of the screen in double-size. To move the text to the lower half of the screen, press it again. For normal display, press it once again.

RETURN

Hold: Holds the display at the current page, in the case that there are several secondary pages that follow automatically. To undo, press it again.

EXIT

Cancel: Shrinks the Teletext display to overlap with the current broadcast. To undo, press it again.

Typical Teletext page

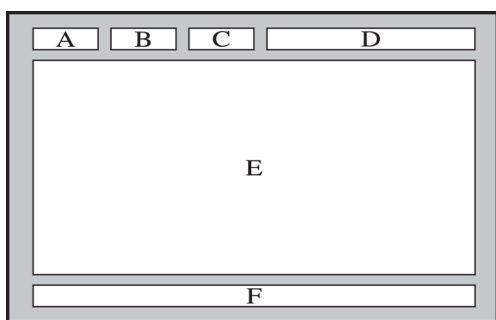

Part	Contents
A	Selected page number.
B	Broadcasting channel identity.
C	Current page number or search indications.
D	Date and time.
E	Text.
F	Status information. FASTEXT information.

Troubleshooting

If you have a problem with your TV, you can access various solutions while watching TV. If your problem is not addressed in the Troubleshooting section, contact the Samsung Call Centre.























Picture Issues











When the TV has trouble with the picture, these steps may help resolve the problem.





















Testing the picture

 >  [Settings](#) > [Support](#) > [Self Diagnosis](#) > [Start Picture Test](#) Try Now

Before you review the list of problems and solutions below, use [Start Picture Test](#) to determine if the problem is caused by the TV. [Start Picture Test](#) displays a high definition picture you can examine for flaws or faults.

The problem	Try this!
Flickering and Dimming	<p>If your Samsung Television is flickering or dimming sporadically, you may need to disable some of the energy efficiency features.</p> <p>Disable Ambient Light Detection, Energy Saving Mode, or Motion Lighting.</p> <ul style="list-style-type: none"> >  Settings > General > Eco Solution > Ambient Light Detection >  Settings > General > Eco Solution > Energy Saving Mode >  Settings > General > Eco Solution > Motion Lighting
Component Connections/ Screen Colour	<p>If the colour on your TV screen is not correct or the black and white colours are off, run Start Picture Test.</p> <ul style="list-style-type: none"> >  Settings > Support > Self Diagnosis > Start Picture Test <p>If the test results indicate that the problem is not caused by the TV, do the following:</p> <p>When using the One Connect, confirm that its video input connectors are connected to the correct external device video output connectors.</p> <p>When using the component cable, confirm that the green (Y), blue (Pb), and red (Pr) jacks are plugged into their proper connectors.</p> <p>For more information about how to connect an external device, run Connection Guide.</p> <ul style="list-style-type: none"> >  Source > Connection Guide
Screen Brightness	<p>If the colours on your Samsung TV are correct but just a little too dark or bright, try adjusting the following settings first.</p> <ul style="list-style-type: none"> >  Settings > Picture > Expert Settings > Backlight >  Settings > Picture > Expert Settings > Contrast >  Settings > Picture > Expert Settings > Brightness >  Settings > Picture > Expert Settings > Sharpness >  Settings > Picture > Expert Settings > Colour >  Settings > Picture > Expert Settings > Tint (G/R)

The problem	Try this!
Blurring, or Juddering	<p>If you notice blurring or juddering on the screen, use the Auto Motion Plus Settings function to resolve the issue.</p> <ul style="list-style-type: none"> •  >  Settings > Picture > Expert Settings > Auto Motion Plus Settings
Unwanted Powering Off	<p>If your TV appears to turn off by itself, try disabling some of the TV's energy efficiency functions.</p> <p>See if Sleep Timer has been enabled. The Sleep Timer automatically turns the TV off after a specified period of time.</p> <ul style="list-style-type: none"> •  >  Settings > General > System Manager > Time > Sleep Timer <p>If the Sleep Timer has not been enabled, see if Auto Power Off or Off Timer has been enabled and disable it.</p> <ul style="list-style-type: none"> •  >  Settings > General > Eco Solution > Auto Power Off •  >  Settings > General > System Manager > Time > Off Timer
Problems Powering On	<p>If you are having problems powering on your TV, there are a number of things to check before calling the service department.</p> <p>Confirm that the TV's power cord is connected correctly at both ends and that the remote control is operating normally.</p> <p>Make sure that the antenna cable or cable TV cable is firmly connected.</p> <p>If you have a cable box or satellite box, confirm that it is plugged in and turned on.</p>
Unable to find a Channel	<p>If your TV is not connected to a cable box or satellite box, run Auto Tuning.</p> <ul style="list-style-type: none"> •  >  Settings > Broadcasting > (Auto Tuning Settings) > Auto Tuning <p> The Auto Tuning Settings may not appear depending on the model or geographical area.</p>
The TV image does not look as good as it did in the store.	<p>Store displays are tuned to a digital UHD channel or HD channel.</p> <p>If you are using analogue cable, upgrade to digital cable.</p> <p>If you use an analogue cable box or satellite box, upgrade to a digital cable box or satellite box and adjust the digital cable box and satellite box's video output resolution to UHD or HD.</p> <p>Be sure to use an HDMI cable to enjoy high quality videos.</p> <p>To connect the TV with your PC, make sure that your PC's graphic card supports UHD resolutions.</p> <p>For more information about the supported UHD resolutions, refer to "Supported Resolutions for UHD Input Signals".</p>
The picture is distorted.	<p>The compression of video content may cause picture distortions, especially in fast moving pictures from sports programmes and action movies.</p> <p>If the signal reception is weak or poor, screen distortion may be visible but it is not a malfunction.</p> <p>Mobile phones used close to the TV (within 1 m) may cause noise on analogue and digital channels.</p>

The problem	Try this!
The colour is wrong or missing.	<p>If you're using a Component connection, make sure that the Component cables are connected to the correct jacks.</p> <p>Incorrect or loose connections may cause colour problems or a blank screen.</p>
The colour is poor or the picture is not bright enough.	<p>Go to Picture and then adjust the Picture Mode, Brightness, Sharpness, and Colour settings.</p> <ul style="list-style-type: none"> •  >  Settings > Picture > Picture Mode •  >  Settings > Picture > Expert Settings > Brightness •  >  Settings > Picture > Expert Settings > Sharpness •  >  Settings > Picture > Expert Settings > Colour <p>See if Energy Saving Mode has been enabled.</p> <ul style="list-style-type: none"> •  >  Settings > General > Eco Solution > Energy Saving Mode <p>Try resetting the picture.</p> <ul style="list-style-type: none"> •  >  Settings > Picture > Expert Settings > Reset Picture
There is a dotted line on the edge of the screen.	<p>Change Picture Size to 16:9 Standard.</p> <ul style="list-style-type: none"> •  >  Settings > Picture > Picture Size Settings > Picture Size > 16:9 Standard
The picture is black and white.	<p>Use a composite cable when you connect AV equipment to the TV.</p> <p>If you are using the composite cable, connect the video cable (Yellow) to the VIDEO (Yellow / Green) input port.</p> <p>Check whether Greyscale is set to On.</p> <ul style="list-style-type: none"> •  >  Settings > General > Accessibility > Greyscale
The picture won't display in full screen.	<p>HD channels will have black bars on either side of the screen when displaying upscaled SD (4:3) content.</p> <p>Black bars will appear at the top and bottom of the screen when you watch movies that have aspect ratios different from your TV.</p> <p>Adjust the picture size options on your external device or set the TV to full screen.</p> <ul style="list-style-type: none"> •  >  Settings > Picture > Picture Size Settings > Picture Size
The Subtitle function in the TV menu is deactivated.	<p>When an external device is connected with an HDMI or Component cable, the Subtitle function is unavailable. Adjust the subtitle setting on the external device.</p>
Subtitles appear on the TV screen.	<p>Turn off the Subtitle function in Subtitle Settings.</p> <ul style="list-style-type: none"> •  >  Settings > General > Accessibility > Subtitle Settings > Subtitle

 If the test picture does not appear or there is noise or distortion, the TV may have a problem. Contact Samsung's Call Centre for assistance.

 If the test picture is displayed properly, there may be a problem with an external device. Please check the connections.

 If the problem persists, check the signal strength or refer to the external device's user manual.







Sound and Noise Issues

When the TV has difficulties with sound, these steps may help resolve the problem.

Testing the sound

 >  [Settings](#) > [Support](#) > [Self Diagnosis](#) > [Start Sound Test](#) Try Now









If the TV plays the [Start Sound Test](#) melody without distortion, there may be a problem with an external device or the broadcast signal's strength.

The problem	Try this!
How can I connect an audio device to the TV?	<p>The connection method may differ depending on the audio device.</p> <p>For more information about how to connect an audio device, run Connection Guide.</p> <ul style="list-style-type: none">•  >  Source > Connection Guide > Audio Device
There is no sound or the sound is too low at maximum volume.	<p>Check the volume control of your TV, and then check the volume control of the external device (cable box or satellite box, DVD, Blu-ray, etc.) connected to your TV.</p>
The picture is good but there is no sound.	<p>Set Sound Output to TV Speaker.</p> <ul style="list-style-type: none">•  >  Settings > Sound > Sound Output <p>If you are using an external device, check the device's audio output option. For example, you may need to change your cable box's audio option to HDMI if the box connected to your TV is using an HDMI cable.</p> <p>To listen to computer sound, connect an external speaker to the computer's audio output connector.</p> <p>If your TV has a headphone jack, make sure there is nothing plugged into it.</p> <p>Reboot the connected device by disconnecting and then reconnecting the device's power cable.</p>
No sound is heard.	<p>Check whether Digital Output Audio Format is set to Dolby Digital+.</p> <p>Set Digital Output Audio Format to Dolby Digital+ only when you play Dolby Digital+ (with Atmos) content.</p> <p>If you are using an AV receiver that does not support Dolby Digital+, you will hear no sound when you select Dolby Digital+.</p> <ul style="list-style-type: none">•  >  Settings > Sound > Expert Settings > Digital Output Audio Format > Dolby Digital+

The problem	Try this!
<p>The speakers are making an odd sound.</p>	<p>Run Start Sound Test.</p> <ul style="list-style-type: none"> • Home > Settings > Support > Self Diagnosis > Start Sound Test <p>Make sure that the audio cable is connected to the correct audio output connector on the external device.</p> <p>For antenna or cable connections, check the signal information. A low signal level may cause sound distortions.</p>
<p>The sound is interrupted.</p>	<p>The sound may frequently be interrupted when a Bluetooth speaker is used. Make sure that the Bluetooth speaker and the wireless access point are on a straight line, and the Bluetooth speaker is placed as close as possible to the TV.</p> <p>To minimise interruptions, we recommend a wireless access point that uses a 5 GHz frequency.</p> <p>If the problem persists, we recommend that you use a wired connection.</p>
<p>Whenever a function is used on the TV or the channel is changed, the TV voices the activity.</p> <p>The TV explains in voice-over the video scenes displayed on the screen.</p>	<p>Turn off the Voice Guide function in Voice Guide Settings.</p> <ul style="list-style-type: none"> • Home > Settings > General > Accessibility > Voice Guide Settings > Voice Guide
<p>The TV audio is not being played through the AV receiver.</p>	<p>Connect an optical cable to the TV and the AV receiver.</p> <p>ARC enables the TV to output digital sound via the HDMI (ARC) port.</p> <p>However, ARC is only available when the TV is connected to an AV receiver that supports ARC.</p>

Channel and Broadcast Issues

When the TV has difficulties receiving broadcasts, these steps may help resolve the problem.

The problem	Try this!
<p>“Weak or No Signal” displayed in TV mode/cannot find channel.</p>	<p>Make sure that the external device is connected securely and turned on. Move to Sources to switch to other input sources.</p> <ul style="list-style-type: none"> •  >  Source > Sources
<p>The TV is not receiving all channels.</p>	<p>Confirm that the coaxial cable is securely connected to the TV.</p> <p>Run Reset or Auto Tuning.</p> <ul style="list-style-type: none"> •  >  Settings > General > Reset •  >  Settings > Broadcasting > (Auto Tuning Settings) > Auto Tuning <p> The Auto Tuning Settings may not appear depending on the model or geographical area.</p>
<p>There are no subtitles with digital channels.</p>	<p>Go to Subtitle Settings and turn on the Subtitle function, and then change the Subtitle Mode.</p> <ul style="list-style-type: none"> •  >  Settings > General > Accessibility > Subtitle Settings <p>Some channels may not have subtitle data.</p>
<p>Broadcasting is deactivated.</p>	<p>Broadcasting is only available when Source is set to TV.</p> <p>Broadcasting cannot be accessed while you watch TV using a cable box or satellite box.</p> <p>Broadcasting cannot be accessed while a recording is in progress or the Timeshift function is running.</p>

External Device Connectivity Issues

When the TV has difficulties connecting to external devices such as a PC, game console, or mobile device, these steps may help resolve the problem.



The problem	Try this!
The "Mode Not Supported" message appears.	Adjust the output resolution of the external device to a resolution supported by the TV.
The video is OK but there is no audio.	<p>If you are using an HDMI connection, check the audio output setting on your PC.</p> <p>If you are using a DVI to HDMI cable, a separate audio cable is required.</p> <p>To listen to the computer sound, connect external speakers to the audio output connection of the computer.</p>
How can I use Screen Mirroring?	<p>To wirelessly connect the TV to your PC, read the instructions at PC > Screen Sharing (Wireless) in Connection Guide, and then try to connect.</p> <ul style="list-style-type: none"> • Home > Source > Connection Guide > PC > Screen Sharing (Wireless) <p>Confirm that the TV and your PC are connected to the same wireless network.</p> <p>To wirelessly connect the TV to your mobile device, read the instructions at Smartphone > Screen Sharing (Smart View) in Connection Guide, and then try to connect.</p> <ul style="list-style-type: none"> • Home > Source > Connection Guide > Smartphone > Screen Sharing (Smart View) <p>If the TV has difficulties connecting to your PC or mobile device due to surrounding radio interferences, change the frequency of the wireless access band, and then try to connect.</p>
No screen appears when connecting the TV to an external device.	<p>For more information about how to connect an external device, run Connection Guide.</p> <ul style="list-style-type: none"> • Home > Source > Connection Guide <p>Make sure that the external device is connected securely and turned on. Move to Sources to switch to other input sources.</p> <ul style="list-style-type: none"> • Home > Source > Sources

Network Issues

When the TV has difficulties connecting to the Internet, these steps may help resolve the problem.









 >  [Settings](#) > [Support](#) > [Self Diagnosis](#) > [Start Smart Hub Connection Test](#) Try Now Try Now



If the TV has trouble with network connection or TV services, check the Smart Hub connection status.

The problem	Try this!
<p>Wireless network connection failed.</p> <p>Unable to connect to a wireless access point.</p>	<p>Make sure that no items that can generate electromagnetic interferences are placed between the TV and the wireless/wired access point.</p> <p>Check if the access point is turned on. If it is on, turn it off, wait 1 or 2 minutes, and then turn it on.</p> <p>Enter the correct password if required.</p> <p>If the wireless connection fails, connect the TV to the access point via a LAN cable.</p> <p>If the TV can connect to the Internet normally via the wired connection, there might be a problem with the access point. In this case, try using a different access point.</p>
<p>Wired network connection failed.</p>	<p>Check if the LAN cable is plugged in on both ends. If it is plugged in, check if the access point is turned on. If it is on, turn it off, wait 1 or 2 minutes, and then turn it on.</p>
<p>Auto IP configuration failed.</p> <p>Unable to connect to the network.</p>	<p>Check if the LAN cable is plugged in on both ends. If it is plugged in, check if the access point is turned on.</p> <p>If the access point is on, turn it off, wait 1 or 2 minutes, and then turn it on.</p> <p>Disconnect and then reconnect the power cable of the access point, or press and hold the power button for 3 seconds.</p>
<p>Connected to a local network, but not to the Internet.</p>	<ol style="list-style-type: none"> 1. Check if the Internet LAN cable is connected to the access point's external LAN port. 2. Check the DNS setting in IP Settings. <ul style="list-style-type: none"> –  >  Settings > General > Network > Network Status > IP Settings
<p>Network setup is completed, but unable to connect to the Internet.</p>	<p>If the problem persists, contact your Internet service provider.</p>

Anynet+ (HDMI-CEC) Issues





When Anynet+ (HDMI-CEC) isn't working, these steps may help resolve the problem.

The problem	Try this!
What is Anynet+?	<p>You can use the TV's remote control to control external devices that support Anynet+ (HDMI-CEC) and that are connected to the TV via an HDMI cable. For example, if a connected external device supports Anynet+, you can have the connected device turn on or off when you turn the TV on or off.</p>
Anynet+ does not work.	<p>Confirm that the device is an Anynet+ device. The Anynet+ system supports Anynet+ devices only.</p> <p>Check if the power cord of the Anynet+ device is properly connected.</p> <p>Check the cable connections of the Anynet+ device.</p> <p>Go to Anynet+ (HDMI-CEC) and see if Anynet+ (HDMI-CEC) has been set to On.</p> <ul style="list-style-type: none"> •  >  Settings > General > External Device Manager > Anynet+ (HDMI-CEC) <p>Anynet+ may not function when some other functions are active, including Channel Search, Smart Hub, Initial Setup, etc.</p> <p>If you have disconnected and then reconnected the HDMI cable, scan for devices again or turn your TV off and on.</p>
I want to start Anynet+. I also want the connected devices to turn on when the TV is turned on.	<p>Move the focus to the Anynet+ device at  >  Source, press the up directional button to move to Anynet+ (HDMI-CEC), and then press the Select button.</p> <p>Check if the Anynet+ device is properly connected to the TV, and then select Anynet+ (HDMI-CEC) menu to see if Anynet+ (HDMI-CEC) is set to On.</p> <ul style="list-style-type: none"> •  >  Settings > General > External Device Manager > Anynet+ (HDMI-CEC)
I want to exit Anynet+. I also do not want the connected devices to turn on and off when the TV is turned on or off.	<p>Turn off the Anynet+ (HDMI-CEC) function.</p> <ul style="list-style-type: none"> •  >  Settings > General > External Device Manager > Anynet+ (HDMI-CEC)
The message "Connecting to Anynet+ device..." or "Disconnecting from Anynet+ device" appears on the screen.	<p>You cannot use the remote control when the TV is configuring Anynet+ or switching to the TV viewing screen.</p> <p>Use the remote control after the TV has completed the Anynet+ configuration or has switched to the TV viewing screen.</p>
The Anynet+ device won't play.	<p>You cannot use the play function when Reset is in progress.</p>

The problem	Try this!
<p>The connected device is not displayed.</p>	<p>Check whether the device supports Anynet+.</p> <p>Check whether the HDMI cable is properly connected.</p> <p>Go to Anynet+ (HDMI-CEC) and see if Anynet+ (HDMI-CEC) has been set to On.</p> <ul style="list-style-type: none"> •  >  Settings > General > External Device Manager > Anynet+ (HDMI-CEC) <p>Scan for Anynet+ devices again.</p> <p>Anynet+ devices must be connected to the TV using an HDMI cable. Make sure the device is connected to your TV with an HDMI cable. Some HDMI cables may not support Anynet+.</p> <p>If the connection is terminated because there has been a power failure or the HDMI cable has been disconnected, please scan for the device again.</p>

Remote Control Issues

When the remote control isn't working, these steps may help resolve the problem.

The problem	Try this!
<p>The remote control does not work.</p>	<p>The connection between the Samsung Smart Remote and the TV may be lost.</p> <p>Point the Samsung Smart Remote at the front of the TV, and then press and hold the  and  buttons simultaneously for 3 seconds or more.</p> <p>Also, if the remote control is not working or slow, the batteries might be low or dead. If this is the case, replace the batteries. Alkaline batteries are recommended for longer battery life.</p>
<p>The remote control batteries run out quickly.</p>	<p>The batteries may be consumed quickly if the remote control is used very frequently or the Voice Wake-up function is turned on.</p> <p>You can extend the battery life by turning off the Voice Wake-up function.</p> <ul style="list-style-type: none"> •  > Explore Now >  Settings > Voice Wake-up

Recording Issues

When Timeshift or Schedule recording aren't working, these steps may help resolve the problem.

The problem	Try this!
The Timeshift or recording function cannot be used.	<p>Check if there is a storage device connected to the TV.</p> <p>Recording will automatically stop if the signal becomes too weak.</p> <p>Check the free space on the storage device.</p> <p>The function will not work if there isn't enough storage space on the storage device.</p> <p>Before using the recording function, be sure to read all precautions. For more information, refer to "Before Using the Recording and Timeshift Functions".</p>
Cannot record videos received from an external device or Samsung TV Plus .	The recording function is only available for digital broadcast channels received by the TV. You cannot record videos received from an external device or Samsung TV Plus .
The "Format Device" message appears when the Timeshift or recording function is used.	<p>To use the recording function, the storage device connected to the TV must have been already formatted.</p> <p>Formatting the storage device deletes all data from it, and the storage device is formatted in NTFS.</p>
The recorded files on the TV are not played back on a PC.	The recorded files on the TV can only be played back on the same TV. Those video files cannot be played back on a PC or other TV.

 This function may not be supported depending on the model or geographical area.

Apps

When apps aren't working, these steps may help resolve the problem.

The problem	Try this!
I launched an app, but it's in English. How can I change the language?	<p>Languages supported by an app may be different from the TV Language set in the menu.</p> <p>The ability to change the language depends on the app's provider.</p>
My application is not working.	<p>The services of your application are not provided by the TV but by the application service provider.</p> <p>Refer to the Help section on the application service provider's website.</p>





Media Files

When files aren't playing, this may help resolve the problem.

The problem	Try this!
Some files are interrupted during playback.	This problem may occur with unsupported files or high-bitrate files. Most files can be played back, but some files may not play smoothly.
Some files can't be played.	Some files that use an unsupported codec may not be played back. Make sure that the codec is supported by the TV. For more information about the supported codecs, refer to " Read Before Playing Photo, Video, or Music Files ".

Voice Recognition Issues







When the voice recognition or Bixby functions aren't working, these steps may help resolve the problem.

The problem	Try this!
Bixby answers automatically.	The TV may recognise an ambient noise or everyday conversation as a call to Bixby. Turn off the Voice Wake-up function or set the sensitivity to Low . <ul style="list-style-type: none"> •  > Explore Now >  Settings > Voice Wake-up
I spoke "Hi, Bixby" but Bixby does not answer.	The Samsung Smart Remote may not recognise your voice when it is far away from you, turned upside down, or located in an environment with loud ambient noise. <ul style="list-style-type: none"> • Use the Samsung Smart Remote less than 2 feet (1.5 m) with the remote control buttons facing upward. (There is a built-in microphone on the front of the Samsung Smart Remote.) • Do not place the Samsung Smart Remote near the TV speaker or an audio speaker. Turn on the Voice Wake-up function. <ul style="list-style-type: none"> •  > Explore Now >  Settings > Voice Wake-up • The Voice Wake-up function may not be supported depending on the model or geographical area.

Other issues

Use these procedures to resolve other issues that may occur in relation to the product.

The problem	Try this!
The TV is hot.	Watching TV for an extended period of time causes the panel to generate heat. The heat from the panel is dissipated through internal vents running along the top of the TV. The bottom, however, may feel hot to the touch after extended use. Children watching TV need constant adult supervision to prevent them from touching the TV. This heat, however, is not a defect and does not affect the TV's functionality.

The problem	Try this!
The TV smells of plastic.	This smell is normal and will dissipate over time.
The settings are lost after 5 minutes or every time the TV is turned off.	<p>If Usage Mode is set to Retail Mode, the TV's audio and video settings are automatically reset every 5 minutes.</p> <p>Change Usage Mode to Home Mode.</p> <ul style="list-style-type: none"> •  >  Settings > General > System Manager > Usage Mode
The TV is tilted to the side.	Remove the base stand from the TV and reassemble it.
The stand is wobbly or crooked.	Make sure the indicator arrows on the stand and stand holder are properly aligned.
PIP is not available.	<p>PIP is available only when an external device is connected with an HDMI or Component cable.</p> <p>Note that the function is unavailable when the Smart Hub is active.</p>
A POP (TV's internal banner ad) appears on the screen.	<p>Change Usage Mode to Home Mode.</p> <ul style="list-style-type: none"> •  >  Settings > General > System Manager > Usage Mode
The TV is making a popping noise.	<p>The expansion and contraction of the TV's outer casing may cause a popping noise. This does not indicate a product malfunction.</p> <p>The TV is safe to use.</p>
The TV is making a humming noise.	<p>Your TV utilises high-speed switching circuits and high levels of electrical current. Depending on the TV's brightness level, the TV may seem slightly noisier than a conventional TV.</p> <p>Your TV has undergone strict quality control procedures that meet our demanding performance and reliability requirements.</p> <p>Some noise coming from the TV is considered normal and is not an acceptable cause for an exchange or refund.</p>
The software update over the Internet has failed.	<p>Check the network connection status.</p> <ul style="list-style-type: none"> •  >  Settings > General > Network > Network Status <p>If the TV is not connected to a network, connect it to a network.</p> <p>The upgrade stops if you already have the latest software version.</p>









Diagnosing TV operational issues

You can diagnose issues with your TV and Smart Hub and run reset functions.

 >  [Settings](#) > [Support](#) > [Self Diagnosis](#) Try Now

You can use the [Picture Test](#) to help diagnose video issues and the [Sound Test](#) to diagnose sound issues. You can also view signal strength information for over-the-air digital signals, test the Smart Hub Internet connection, and run the Smart Hub reset functions.

- [Start Picture Test](#)
- [Start Sound Test](#)
- [Signal Information](#)
- [TV Device Manager](#)
- [Start Smart Hub Connection Test](#)
- [Reset Smart Hub](#)

The problem	Try this!
Cannot select Signal Information in Self Diagnosis .	Verify that the current channel is a digital channel. Signal Information is only available for digital channels. <ul style="list-style-type: none"> •  >  Settings > Support > Self Diagnosis > Signal Information
Reset Smart Hub	Resets all Smart Hub settings to their factory defaults and deletes all information related to Samsung accounts, linked service accounts, Smart Hub service agreements, and Smart Hub applications. <ul style="list-style-type: none"> •  >  Settings > Support > Self Diagnosis > Reset Smart Hub
Reset picture	Resets current picture settings to the default settings. <ul style="list-style-type: none"> •  >  Settings > Picture > Expert Settings > Reset Picture
Reset sound	Resets current sound settings to the default settings. <ul style="list-style-type: none"> •  >  Settings > Sound > Expert Settings > Reset Sound

Getting Support

Get help directly from Samsung if you have a problem with your TV.

Getting support through Remote Management

 >  [Settings](#) > [Support](#) > [Remote Management](#) [Try Now](#)

After consenting to our service agreement, you can use [Remote Management](#) to access Remote Support and have a Samsung service technician diagnose your TV, correct problems, and update your TV's software remotely via the web. You can also turn [Remote Management](#) on and off.

 This function requires an Internet connection.



 You can also start [Remote Management](#) function by pressing and holding the  button for 5 or more seconds.

Finding the contact information for service

 >  [Settings](#) > [Support](#) > [About This TV](#) [Try Now](#)

You can view the address of the Samsung website, the call centre phone number, your TV's model number, your TV's software version, Open Source Licence and other information you may need to get service support from a Samsung call agent or the Samsung website.

 You can also view information by scanning the QR code of your TV.

 You can also start this function by pressing and holding the  button for 5 or more seconds. For the standard remote control, press and hold the  (Play) button for 5 or more seconds. Continue holding the button until the customer information pop-up window appears.

Requesting service

 >  [Settings](#) > [Support](#) > [Request Support](#) [Try Now](#)

You can request service when you encounter a problem with the TV. Select the item matching the problem that you encountered, move the focus to [Next](#), and then press the Select button. Select [Request Now](#) or [Schedule Appointment](#) > [Request](#) > [Send](#). Your service request will be registered. The Samsung Contact Centre will contact you to set up or confirm your service appointment.

 You must agree to the terms and conditions for the service request.

 This function may not be supported depending on the geographical area.

 This function requires an Internet connection.

Precautions and Notes

You can get instructions and information that you must read after installation.



Before Using the Recording and Timeshift Functions





Read these instructions before using Recording and Timeshift.

 This function may not be supported depending on the model or geographical area.

Before using the recording and schedule recording functions

 Recording may not be supported depending on the model or geographical area.

- To set up a Schedule Recording, you must first set the TV's clock. Set the **Clock**.
 -  >  **Settings** > **General** > **System Manager** > **Time** > **Clock**
- You can set up a maximum total of 30 **Schedule Viewing** and **Schedule Recording** entries.
- Recordings are DRM-protected and therefore cannot be played back on a computer or on a different TV. In addition, these files cannot be played back on your TV if its video circuit has been replaced.
- A USB hard drive with a speed of 5,400 rpm or above is recommended. However, RAID-type USB hard drives are not supported.
- USB memory sticks are not supported.
- The total recording capacity may differ with the amount of available hard drive space and the recording quality level.

- **Schedule Recording** requires at least 100 MB of free space on the USB storage device. Recording will stop if the available storage space falls below 50 MB while recording is in progress.
- If the available storage space falls below 500 MB while both the Schedule Recording and Timeshift functions are in progress, only the recording will stop.
- The maximum recording time is 720 minutes.
- Videos are played according to the TV settings.
- If the input signal is changed while recording is in progress, the screen will go blank until the change is made. In this case, recording will resume, but ● will not be available.
- When using the Record or Schedule Recording function, the actual recording may start a second or two later than the specified time.
- If the Schedule Recording function is operating while a recording is being made on an HDMI-CEC external device, the priority is given to the Schedule Recording.
- Connecting a recording device to the TV automatically deletes abnormally saved recorded files.
- If the **Sleep Timer** or **Auto Power Off** has been set, the TV will override these settings, continue to record, and turn off after the recording has ended.
 -  >  **Settings** > **General** > **System Manager** > **Time** > **Sleep Timer**
 -  >  **Settings** > **General** > **Eco Solution** > **Auto Power Off**

Before using the timeshift function

-  Timeshift may not be supported depending on the model or geographical area.
- A USB hard drive with a speed of 5,400 rpm or above is recommended. However, RAID-type USB hard drives are not supported.
- USB memory sticks or flash drives are not supported.
- The total recording capacity may differ with the amount of available hard drive space and the recording quality level.
- If the available storage space falls below 500 MB while both the Schedule Recording and Timeshift functions are in progress, only the recording will stop.
- The maximum amount of time available for the Timeshift function is 90 minutes.
- The Timeshift function is not available for locked channels.
- Time-shifted videos are played according to the TV settings.
- The Timeshift function may be terminated automatically once it reaches its maximum capacity.
- The Timeshift function requires at least 1.5 GB of free space available on the USB storage device.

Supported broadcasting audio options

Check the supported broadcasting audio options.

	Audio Type	Dual Sound	Default
A2 Stereo	Mono	Mono	Automatic change
	Stereo	Stereo, Mono	Automatic change
	Dual	Dual I, Dual II	Dual I
NICAM Stereo	Mono	Mono	Automatic change
	Stereo	Mono, Stereo	Automatic change
	NICAM Dual	Mono, NICAM Dual-1, NICAM Dual-2	NICAM Dual-1

 If the **Stereo** signal is too weak and an automatic switching occurs, select **Mono**.

 Available only for the stereo signals.

 Available only when the input source is set to **TV**.

Read Before Using APPS

Read this information before using APPS.

- If you want to download new apps using [APPS](#), first sign in to your Samsung account.
- Due to the product characteristics featured on Samsung Smart Hub, as well as limitations in available content, certain features, applications, and services may not be available on all devices or in all territories. Visit <http://www.samsung.com> for more information on specific device information and content availability. Services and content availability are subject to change without prior notice.
- Samsung Electronics takes no legal responsibility whatsoever for any interruption of app services caused by the service provider for any reason.
- Application services may be provided in English only and available content may differ with the geographical area.
- For more information about applications, visit the applicable service provider's website.
- An unstable Internet connection may cause delays or interruptions. In addition, applications may terminate automatically depending on the network environment. If this occurs, check your Internet connection and try again.
- Application services and updates may become unavailable.
- Application content is subject to change by the service provider without prior notice.
- Specific services may differ with the version of the application installed on the TV.
- An application's functionality may change in future versions of the application. If this occurs, run the application's tutorial or visit the service provider's website.
- Depending on the service provider's policies, certain applications may not support multitasking.

Read Before Using the Internet Function

Read this information before using the Internet.

- File download is not supported.
 - The **Internet** function may not be able to access certain websites, including websites operated by certain companies.
 - The TV does not support playback of flash videos.
 - E-commerce for online purchases is not supported.
 - ActiveX is not supported.
 - Only a limited number of fonts are supported. Certain symbols and characters may not be displayed properly.
 - The response to remote commands and the resulting on-screen display may be delayed while a web page is loading.
 - Loading a web page may be delayed or suspended completely depending on the status of the participating systems.
 - Copy and paste operations are not supported.
 - When composing an email or a simple message, certain functions such as the font size and colour selection may not be available.
 - There is a limit to the number of bookmarks and the size of the log file that can be saved.
 - The number of windows that can be opened concurrently is limited.
 - Web browsing speed will differ with the network environment.
 - Embedded videos in a web page cannot be played at the same time while the PIP (picture-in-picture) function is operating.
-  This function may not be supported depending on the model or geographical area.
- Browsing history is saved from latest to oldest, with the oldest entries being overwritten first.
 - Depending on the types of video/audio codecs supported, you may not be able to play certain HTML5 video and audio files.
 - Video sources from PC-optimised streaming service providers may not play properly on our proprietary **Internet** browser.

Read before setting up a wireless Internet connection

Precautions for wireless Internet

- This TV supports the IEEE 802.11 a /b /g /n /ac communication protocols. Samsung recommends using IEEE 802.11n. Video files stored on a device connected to the TV via a Home Network may not play back smoothly.
 Some of the IEEE 802.11 communication protocols may not be supported depending on the model or geographical area.
- To use wireless Internet, the TV must be connected to a wireless access point or modem. If the wireless access point supports DHCP, the TV can use a DHCP or static IP address to connect to the wireless network.
- Select a channel that is not currently in use for the wireless access point. If the channel set is currently being used by the wireless access point to communicate with another device, the result is usually interference and/or a communications failure.
- Most wireless networks have an optional security system. To enable a wireless network's security system, you need to create a password using characters and numbers. This password is then needed to connect to a security-enabled access point.

Wireless security protocols

The TV only supports the following wireless network security protocols. The TV cannot connect to non-certified wireless access point.

- Authentication Modes: WEP, WPAPSK, WPA2PSK
- Encryption Types: WEP, TKIP, AES

In compliance with the Wi-Fi certification specifications, Samsung TVs do not support WEP or TKIP security encryption in networks running in the 802.11n mode. If the wireless access point supports WPS (Wi-Fi Protected Setup), you can connect the TV to your network using PBC (Push Button Configuration) or a PIN (Personal Identification Number). WPS automatically configures the SSID and WPA key settings.

Read Before Playing Photo, Video, or Music Files

Read this information before playing media content.

Limitations on use of photo, video, and music files [Try Now](#)

- The TV supports MSC (Mass Storage Class) USB devices only. MSC is a class designation for mass storage devices. Types of MSC devices include external hard drives, flash card readers, and digital cameras. (USB hubs are not supported.) These kinds of devices must be connected directly to the USB port. The TV may not be able to recognise a USB device or read the files on the device if it is connected with a USB extension cable. Do not disconnect USB devices while they are transferring files.
- When connecting an external hard drive, use the USB (HDD 5V1A) port. We recommend that you use an external hard drive with its own power adapter.
- Certain digital cameras and audio devices may not be compatible with the TV.
- If there are multiple USB devices connected to the TV, the TV might not be able to recognise some or all the devices. USB devices that use high-power input should be connect to the USB (HDD 5V1A) port.
- The TV supports the FAT, exFAT, and NTFS file systems.
- In the media contents list, the TV can display up to 1,000 files per folder. If the USB device contains more than 8,000 files and folders, however, some files and folders might not be accessible.
- Certain files, depending on how they are encoded, may not play on the TV.
- Certain files are not supported on all models.
- The DivX and DTS codecs are not supported by the Samsung TV models released in 2019.

Supported subtitles

Subtitle formats

Name	Format
MPEG-4 Timed text	.txt
SAMI	.smi
SubRip	.srt
SubViewer	.sub
Micro DVD	.sub or .txt
SubStation Alpha	.ssa
Advanced SubStation Alpha	.ass
SMPTE-TT Text	.xml

Video formats with subtitles

Name	Container
Xsub	AVI
SubStation Alpha	MKV
Advanced SubStation Alpha	MKV
SubRip	MKV
VobSub	MKV
MPEG-4 Timed text	MP4
TTML in smooth streaming	MP4
SMPTE-TT TEXT	MP4
SMPTE-TT PNG	MP4

Supported image formats and resolutions

File extension	Format	Resolution
*.jpg *.jpeg	JPEG	15360 x 8640
*.png	PNG	4096 x 4096
*.bmp	BMP	4096 x 4096
*.mpo	MPO	15360 x 8640

 The MPO format is supported partly.

Supported music formats and codecs

File extension	Format	Codec	Note
*.mp3	MPEG	MPEG1 Audio Layer 3	
*.m4a *.mpa *.aac	MPEG4	AAC	
*.flac	FLAC	FLAC	Supports up to 2 channels
*.ogg	OGG	Vorbis	Supports up to 2 channels
*.wma	WMA	WMA	WMA is supported up to 10 Pro 5.1 channels. WMA lossless audio is not supported.
*.wav	wav	wav	
*.mid *.midi	midi	midi	Supports type 0 and type 1. Seek is not supported. Supports USB device only.
*.ape	ape	ape	
*.aif *.aiff	AIFF	AIFF	
*.m4a	ALAC	ALAC	

Video codecs supported by RU8 model series or higher

File format	Container	Video codecs	Resolution	Frame rate (fps)	Bitrate (Mbps)	Audio codecs
*.avi *.mkv *.asf *.wmv *.mp4 *.mov *.3gp *.vro *.mpg *.mpeg *.ts *.tp *.trp *.flv *.vob *.svi *.m2ts *.mts	AVI MKV ASF MP4 3GP MOV FLV VRO VOB PS TS SVAF	H.264 BP/MP/HP	4096 x 2160	4096 x 2160: 30 3840 x 2160: 60	60	Dolby Digital LPCM ADPCM(IMA, MS) AAC HE-AAC WMA Dolby Digital+ MPEG(MP3) MPEG-H AC-4 G.711(A-Law, μ-Law) OPUS
		HEVC (H.265 - Main, Main10)		60	80	
		Motion JPEG	3840 x 2160	30	80	
		MVC	1920 x 1080	60	20	
		MPEG4 SP/ASP				
		Window Media Video v9 (VC1)				
		MPEG2				
		MPEG1				
		Microsoft MPEG-4 v1, v2, v3				
		Window Media Video v7 (WMV1), v8 (WMV2)		30		
		H.263 Sorrenson				
		VP6				
*.webm	WebM	VP8		1920 x 1080	60	20
		VP9 (Profile 0, profile 2 supported)	3840 x 2160	3840 x 2160: 60	80	
*.rmvb	RMVB	RV8/9/10 (RV30/40)	1920 x 1080	60	20	RealAudio 6

Video codecs supported by RU7 model series or lower

File format	Container	Video codecs	Resolution	Frame rate (fps)	Bitrate (Mbps)	Audio codecs	
*.avi *.mkv *.asf *.wmv *.mp4 *.mov *.3gp *.vro *.mpg *.mpeg *.ts *.tp *.trp *.flv *.vob *.svi *.m2ts *.mts	AVI MKV ASF MP4 3GP MOV FLV VRO VOB PS TS SVAF	H.264 BP/MP/HP	4096 x 2160	4096 x 2160: 30 3840 x 2160: 60	60	Dolby Digital LPCM ADPCM(IMA, MS) AAC HE-AAC WMA Dolby Digital+ MPEG(MP3) MPEG-H AC-4 G.711(A-Law, μ -Law) OPUS	
		HEVC (H.265 - Main, Main10)	3840 x 2160	60	80		
		Motion JPEG	3840 x 2160	30	80		
		MVC	1920 x 1080	60	20		
		MPEG4 SP/ASP					
		Window Media Video v9 (VC1)					
		MPEG2					
		MPEG1					
		Microsoft MPEG-4 v1, v2, v3					
		Window Media Video v7 (WMV1), v8 (WMV2)					30
		H.263 Sorrenson					
		VP6					
*.webm	WebM	VP8				1920 x 1080	60
		VP9 (Profile 0, profile 2 supported)	3840 x 2160	3840 x 2160: 60	80		
*.rmvb	RMVB	RV8/9/10 (RV30/40)	1920 x 1080	60	20	RealAudio 6	

Other restrictions

- Codecs may not function properly if there is a problem with the content.
- Video content does not play or does not play correctly if there is an error in the content or container.
- Sound or video may not work if they have standard bit rates/frame rates above the TV's compatibility ratings.
- If the Index Table is has an error, the Seek (Jump) function will not work.
- When playing video over a network connection, the video may not play smoothly because of data transmission speeds.
- Some USB/digital camera devices may not be compatible with the TV.
- HEVC codec is only available in MKV / MP4 / TS containers.
- The MVC codec is supported partly.

Video decoders

- H.264 UHD is supported up to Level 5.1, and H.264 FHD is supported up to Level 4.1. (TV does not support FMO / ASO / RS)
- HEVC UHD is supported up to Level 5.1, and HEVC FHD is supported up to Level 4.1.
- VC1 AP L4 is not supported.
- GMC 2 or above is not supported.

Audio decoders

- WMA is supported up to 10 Pro 5.1 channels.
- WMA1, WMA lossless / Voice are not supported.
- QCELP and AMR NB / WB are not supported.
- Vorbis is supported for up to 5.1 channels.
- Dolby Digital+ is supported for up to 5.1 channels.
- The supported sample rates are 8, 11.025, 12, 16, 22.05, 24, 32, 44.1, and 48 KHz, and differ with the codec.

Video codecs supported by Q900RB model series

File format	Container	Video codecs	Resolution	Frame rate (fps)	Bitrate (Mbps)	Audio codecs	
*.avi *.mkv *.asf *.wmv *.mp4 *.mov *.3gp *.vro *.mpg *.mpeg *.ts *.tp *.trp *.flv *.vob *.svi *.m2ts *.mts	AVI MKV ASF MP4 3GP MOV FLV VRO VOB PS TS SVAF	H.264 BP/MP/HP	4096 x 2160	4096 x 2160: 30 3840 x 2160: 60	60	Dolby Digital LPCM ADPCM(IMA, MS) AAC HE-AAC WMA Dolby Digital+ MPEG(MP3) MPEG-H AC-4 G.711(A-Law, μ -Law) OPUS	
		HEVC (H.265 - Main, Main10)	7680 x 4320	60	100		
		Motion JPEG	3840 x 2160	30	80		
		MVC	1920 x 1080	60	20		
		MPEG4 SP/ASP					
		Window Media Video v9 (VC1)					
		MPEG2					
		MPEG1					
		Microsoft MPEG-4 v1, v2, v3					
		Window Media Video v7 (WMV1), v8 (WMV2)					30
		H.263 Sorrenson					
		VP6					
*.webm	WebM	VP8				1920 x 1080	60
		VP9 (Profile 0, profile 2 supported)	3840 x 2160	3840 x 2160: 60	80		
*.rmvb	RMVB	RV8/9/10 (RV30/40)	1920 x 1080	60	20	RealAudio 6	

Other restrictions

- Codecs may not function properly if there is a problem with the content.
- Video content does not play or does not play correctly if there is an error in the content or container.
- Sound or video may not work if they have standard bit rates/frame rates above the TV's compatibility ratings.
- If the Index Table is has an error, the Seek (Jump) function will not work.
- When playing video over a network connection, the video may not play smoothly because of data transmission speeds.
- Some USB/digital camera devices may not be compatible with the TV.
- HEVC codec is only available in MKV / MP4 / TS containers.
- The MVC codec is supported partly.

Video decoders

- H.264 UHD is supported up to Level 5.1, and H.264 FHD is supported up to Level 4.1. (TV does not support FMO / ASO / RS)
- HEVC UHD is supported up to Level 5.1, and HEVC FHD is supported up to Level 4.1.
- HEVC 8K is supported up to Level 6.1.
- VC1 AP L4 is not supported.
- GMC 2 or above is not supported.

Audio decoders

- WMA is supported up to 10 Pro 5.1 channels.
- WMA1, WMA lossless / Voice are not supported.
- QCELP and AMR NB/WB are not supported.
- Vorbis is supported for up to 5.1 channels.
- Dolby Digital+ is supported for up to 5.1 channels.
- The supported sample rates are 8, 11.025, 12, 16, 22.05, 24, 32, 44.1, and 48 KHz, and differ with the codec.

Read After Installing the TV

Read this information after installing the TV.

Picture sizes and input signals

The **Picture Size** is applied to the current source. The applied **Picture Size** will remain in effect whenever you select that source unless you change them.

Input signal	Picture size
Component	16:9 Standard, Custom, 4:3
Digital channel (720p)	16:9 Standard, Custom, 4:3
Digital channel (1080i, 1080p)	16:9 Standard, Custom, 4:3
Digital channel (3840 x 2160p @ 24/30 Hz)	16:9 Standard, Custom
Digital channel (3840 x 2160p @ 50/60 Hz)	16:9 Standard, Custom
Digital channel (4096 x 2160p)	16:9 Standard, Custom
HDMI (720p)	16:9 Standard, Custom, 4:3
HDMI (1080i, 1080p)	16:9 Standard, Custom, 4:3
HDMI (3840 x 2160p)	16:9 Standard, Custom
HDMI (4096 x 2160p)	16:9 Standard, Custom
*HDMI (7680 x 4320p)	16:9 Standard, Custom
USB (720p)	16:9 Standard, Custom, 4:3
USB (1080i/p @ 60 Hz)	16:9 Standard, Custom, 4:3
USB (3840 x 2160p @ 24/30 Hz)	16:9 Standard, Custom
USB (3840 x 2160p @ 60 Hz) USB (4096 x 2160p @ 24/30/60 Hz)	16:9 Standard, Custom
*USB (7680 x 4320p @ 24/30/60 Hz)	16:9 Standard, Custom

 *: This input signal is supported by Q900RB model series.

 The input ports for external devices may differ depending on the model and geographical area.

Installing an anti-theft lock

An anti-theft lock is a physical device that can be used to protect the TV against theft. Look for the lock slot on the back of the TV. The slot has a  icon next to it. To use the lock, wrap the lock cable around an object that is too heavy to carry and then thread it through the TV's lock slot. The lock is sold separately. The method of using an anti-theft lock may differ for each TV model. Refer to the lock's user manual for more information.

 This function may not be supported depending on the model or geographical area.

Supported Resolutions for UHD Input Signals

Check the supported resolution for UHD input signals.

- Resolution: 3840 x 2160p, 4096 x 2160p

If Input Signal Plus is set to Off

Frame rate (fps)	Colour Depth / Chroma Sampling	RGB 4:4:4	YCbCr 4:4:4	YCbCr 4:2:2	YCbCr 4:2:0
50 / 60	8 bit	-	-	-	0

If Input Signal Plus is set to On

- For One Connect unsupported models:

Frame rate (fps)	Colour Depth / Chroma Sampling	RGB 4:4:4	YCbCr 4:4:4	YCbCr 4:2:2	YCbCr 4:2:0
50 / 60	8 bit	0	0	0	0
	10 bit	-	-	0	0
	12 bit	-	-	0	0

- For One Connect supported models:

Frame rate (fps)	Colour Depth / Chroma Sampling	RGB 4:4:4	YCbCr 4:4:4	YCbCr 4:2:2	YCbCr 4:2:0
50 / 60	8 bit	0	0	0	0
	10 bit	*0	*0	0	0
	12 bit	-	-	0	0
120	10 bit	-	-	-	*0



*: These specifications are supported for the HDMI 4 port.

Resolutions for Input Signals supported by Q900RB model series

Check the resolutions for input signals supported by Q900RB model series.

If Input Signal Plus is set to On

- 3840 x 2160

Frame rate (fps)	Colour Depth / Chroma Sampling	RGB 4:4:4	YCbCr 4:4:4	YCbCr 4:2:2	YCbCr 4:2:0
50 / 60	8 bit	0	0	0	0
	10 bit	*0	*0	0	0
	12 bit	-	-	0	0
120	10 bit	*0	*0	*0	*0

 *: These specifications are supported for the HDMI 4 port.

- 7680 x 4320

Frame rate (fps)	Colour Depth / Chroma Sampling	RGB 4:4:4	YCbCr 4:4:4	YCbCr 4:2:2	YCbCr 4:2:0
30	8 bit / 10 bit	*0	*0	*0	*0
60	10 bit	-	-	-	*0

 *: These specifications are supported for the HDMI 4 port. Use an HDMI cable that supports these specifications.

Supported Resolutions for FreeSync

Check the supported resolutions for the FreeSync function.

- Settings of FreeSync mode: **Off** / **Ultimate** (48~120 Hz) / **Basic** (90~120 Hz)

 The supported FreeSync modes may differ depending on the external device.

Resolution (Dots x lines)	Display format	Horizontal frequency (KHz)	Vertical frequency (Hz)	Clock frequency (MHz)	SCAN
1920 x 1080	120 Hz	135.000	120.000	297.000	progressive
2560 x 1440	120 Hz	150.000	120.000	495.000	progressive

 This function may not be supported depending on the model or geographical area.

Read Before Connecting a Computer (Supported Resolutions)

Check the supported resolution for PC input signals.

When you connect your TV to a computer, set the computer's video card to one of the standard resolutions listed in the tables below or on the next pages. The TV will automatically adjust to the resolution you choose. Note that the optimal and recommended resolutions are 3840 x 2160 at 60 Hz (UHD model series) and 7680 x 4320 at 60 Hz (Q900RB model series). Choosing a resolution not included in the tables can result in a blank screen or just the power indicator turning on. Refer to the user manual of your graphics card for compatible resolutions.

 The native resolutions are 3840 x 2160 at 60 Hz (UHD model series) and 7680 x 4320 at 60 Hz (Q900RB model series) with the **Input Signal Plus** set to **On**. The native resolution is 3840 x 2160 at 30 Hz with the **Input Signal Plus** set to **Off**.

IBM

Resolution (Dots x lines)	Display format	Horizontal frequency (KHz)	Vertical frequency (Hz)	Clock frequency (MHz)	Polarity (horizontal / vertical)
720 x 400	70 Hz	31.469	70.087	28.322	- / +

MAC

Resolution (Dots x lines)	Display format	Horizontal frequency (KHz)	Vertical frequency (Hz)	Clock frequency (MHz)	Polarity (horizontal / vertical)
640 x 480	67 Hz	35.000	66.667	30.240	- / -
832 x 624	75 Hz	49.726	74.551	57.284	- / -
1152 x 870	75 Hz	68.681	75.062	100.000	- / -

VESA DMT

Resolution (Dots x lines)	Display format	Horizontal frequency (KHz)	Vertical frequency (Hz)	Clock frequency (MHz)	Polarity (horizontal / vertical)
640 x 480	60 Hz	31.469	59.940	25.175	- / -
640 x 480	72 Hz	37.861	72.809	31.500	- / -
640 x 480	75 Hz	37.500	75.000	31.500	- / -
800 x 600	60 Hz	37.879	60.317	40.000	+ / +
800 x 600	72 Hz	48.077	72.188	50.000	+ / +
800 x 600	75 Hz	46.875	75.000	49.500	+ / +
1024 x 768	60 Hz	48.363	60.004	65.000	- / -
1024 x 768	70 Hz	56.476	70.069	75.000	- / -
1024 x 768	75 Hz	60.023	75.029	78.750	+ / +
1152 x 864	75 Hz	67.500	75.000	108.000	+ / +
1280 x 720	60 Hz	45.000	60.000	74.250	+ / +
1280 x 800	60 Hz	49.702	59.810	83.500	- / +
1280 x 1024	60 Hz	63.981	60.020	108.000	+ / +
1280 x 1024	75 Hz	79.976	75.025	135.000	+ / +
1440 x 900	60 Hz	55.935	59.887	106.500	- / +
1600 x 900	60 Hz	60.000	60.000	108.000	+ / +
1680 x 1050	60 Hz	65.290	59.954	146.250	- / +
1920 x 1080	60 Hz	67.500	60.000	148.500	+ / +

VESA CVT

Resolution (Dots x lines)	Display format	Horizontal frequency (KHz)	Vertical frequency (Hz)	Clock frequency (MHz)	Polarity (horizontal / vertical)
2560 x 1440	60 Hz	88.787	59.951	241.500	+ / -
2560 x 1440	120 Hz	192.996	119.998	497.750	+ / -

 The resolution may not be supported depending on the model.

CTA-861

Resolution (Dots x lines)	Display format	Horizontal frequency (KHz)	Vertical frequency (Hz)	Clock frequency (MHz)	Polarity (horizontal / vertical)
*1920 x 1080	100 Hz	112.500	100.000	297.000	+ / +
*1920 x 1080	120 Hz	135.000	120.003	297.000	+ / +
3840 x 2160	30 Hz	67.500	30.000	297.000	- / -
*3840 x 2160	60 Hz	135.000	60.000	594.000	- / -
*3840 x 2160	100 Hz	225.000	100.000	1188.000	+ / +
*3840 x 2160	120 Hz	270.000	120.000	1188.000	+ / +
*4096 x 2160	100 Hz	225.000	100.000	1188.000	+ / +
*4096 x 2160	120 Hz	270.000	120.000	1188.000	+ / +
*7680 x 4320	50 Hz	220.000	50.000	2376.000	+ / +
*7680 x 4320	60 Hz	264.000	60.000	2376.000	+ / +

 *: The resolution may not be supported depending on the model.

Supported Resolutions for Video Signals

Check the supported resolution for video signals.

CTA-861

Resolution (Dots x lines)	Display format	Horizontal frequency (KHz)	Vertical frequency (Hz)	Clock frequency (MHz)	Polarity (horizontal / vertical)
720 (1440) x 576i	50 Hz	15.625	50.000	27.000	- / -
720 (1440) x 480i	60 Hz	15.734	59.940	27.000	- / -
720 x 576	50 Hz	31.250	50.000	27.000	- / -
720 x 480	60 Hz	31.469	59.940	27.000	- / -
1280 x 720	50 Hz	37.500	50.000	74.250	+ / +
1280 x 720	60 Hz	45.000	60.000	74.250	+ / +
1920 x 1080i	50 Hz	28.125	50.000	74.250	+ / +
1920 x 1080i	60 Hz	33.750	60.000	74.250	+ / +
1920 x 1080	24 Hz	27.000	24.000	74.250	+ / +
1920 x 1080	25 Hz	28.125	25.000	74.250	+ / +
1920 x 1080	30 Hz	33.750	30.000	74.250	+ / +
1920 x 1080	50 Hz	56.250	50.000	148.500	+ / +
*1920 x 1080	100 Hz	112.500	100.000	297.000	+ / +
*1920 x 1080	120 Hz	135.000	120.003	297.000	+ / +
1920 x 1080	60 Hz	67.500	60.000	148.500	+ / +
3840 x 2160	24 Hz	54.000	24.000	297.000	+ / +
3840 x 2160	25 Hz	56.250	25.000	297.000	+ / +
3840 x 2160	30 Hz	67.500	30.000	297.000	+ / +
*3840 x 2160	50 Hz	112.500	50.000	594.000	+ / +
*3840 x 2160	60 Hz	135.000	60.000	594.000	+ / +
*3840 x 2160	100 Hz	225.000	100.000	1188.000	+ / +
*3840 x 2160	120 Hz	270.000	120.000	1188.000	+ / +

Resolution (Dots x lines)	Display format	Horizontal frequency (KHz)	Vertical frequency (Hz)	Clock frequency (MHz)	Polarity (horizontal / vertical)
4096 x 2160	24 Hz	54.000	24.000	297.000	+ / +
4096 x 2160	25 Hz	56.250	25.000	297.000	+ / +
4096 x 2160	30 Hz	67.500	30.000	297.000	+ / +
*4096 x 2160	50 Hz	112.500	50.000	594.000	+ / +
*4096 x 2160	60 Hz	135.000	60.000	594.000	+ / +
*4096 x 2160	100 Hz	225.000	100.000	1188.000	+ / +
*4096 x 2160	120 Hz	270.000	120.000	1188.000	+ / +
*7680 x 4320	50 Hz	220.000	50.000	2376.000	+ / +
*7680 x 4320	60 Hz	264.000	60.000	2376.000	+ / +

 *: The resolution may not be supported depending on the model.

VESA CVT

Resolution (Dots x lines)	Display format	Horizontal frequency (KHz)	Vertical frequency (Hz)	Clock frequency (MHz)	Polarity (horizontal / vertical)
2560 x 1440	60 Hz	88.787	59.951	241.500	+ / -
2560 x 1440	120 Hz	192.996	119.998	497.750	+ / -

 The resolution may not be supported depending on the model.

Read Before Using Bluetooth Devices

Read this information before using a Bluetooth device.

 This function may not be supported depending on the model or geographical area.

Restrictions on using Bluetooth

- You can't use Bluetooth devices and the [Wi-Fi Speaker Surround Setup](#) feature simultaneously.
- Compatibility issues may occur, depending on the Bluetooth device. (A Mobile exclusive headphone may not be available, depending on the environment.)
- Lip-sync errors may occur.
- The TV and Bluetooth device may disconnect, depending on the distance between them.
- A Bluetooth device may hum or malfunction:
 - When a part of your body is in contact with the receiving/transmitting system of the Bluetooth device or the TV.
 - When the device is subject to electrical variation from obstructions caused by a wall, corner, or office partitioning.
 - When the device is exposed to electrical interference from same frequency-band devices including medical equipment, microwave ovens, and wireless LANs.
- If the problem persists, we recommend you use a wired connection.
 - DIGITAL AUDIO OUT (OPTICAL) port
 - HDMI (ARC) port

Licences

Check the licence information and trademarks applied in your TV.



Manufactured under license from Dolby Laboratories. Dolby, Dolby Audio, Pro Logic, and the double-D symbol are trademarks of Dolby Laboratories.



The terms HDMI and HDMI High-Definition Multimedia Interface, and the HDMI Logo are trademarks or registered trademarks of HDMI Licensing LLC in the United States and other countries.

Open Source License Notice

Open Source used in this product can be found on the following webpage. (<http://opensource.samsung.com>) Open Source License Notice is written only English.



Trademark: Rovi and Rovi Guide are trademarks of Rovi Corporation and/or its subsidiaries.

License: The Rovi Guide system is manufactured under licence from Rovi Corporation and/or its subsidiaries.

Patent: The Rovi Guide system is protected by patents and patent applications filed in the US, Europe, and other countries including one or more of the United States patents 6,396,546; 5,940,073; 6,239,794 issued to Rovi Corporation and/or its subsidiaries.

Disclaimer: Rovi Corporation and/or its subsidiaries and related affiliates are not in any way liable for the accuracy or availability of the programme schedule information or other data in the Rovi Guide system and cannot guarantee service availability in your area. In no event shall Rovi Corporation and/or its related affiliates be liable for any damages in connection with the accuracy or availability of the programme schedule information or other data in the Rovi Guide system.



POWERED BY



 This licence may not be supported depending on the model or geographical area.

Accessibility Guidance

Provides a menu and a remote control guide that aid the visually impaired.

Menu Learning Screen

Learn the menus on the TV screen. Once enabled, your TV will tell you the structure and features of the menus you select.

Using the Remote control

You can see the description of the buttons on the Samsung Smart Remote.

 The Samsung Smart Remote may not be supported depending on the model or geographical area.











Orientation of the Samsung Smart Remote



Hold the remote control with the buttons facing towards you. The remote is slightly thinner towards the top and thicker towards the bottom.

Description of the Samsung Smart Remote

 The images, buttons, and functions of the Samsung Smart Remote may differ with the model or geographical area.





From top to bottom and left to right:

- The  or  button is at the top left.
- There is a small LED at the right side of the  or  button, but you cannot find it by touching with hand.
- Below the LED is a round button which is the  button.
- Of the two buttons below the  button on the Samsung Smart Remote that comes with the QLED and SERIF TVs, the left one is the  button and the right one the  button.
- Of the two buttons below the  button on the Samsung Smart Remote that comes with the UHD TV or THE FRAME, the left one is the  button and the right one the  button.

- If you press the  button twice or press the  button while viewing a programme, the ~~Record, Timeshift, Stop~~ (when Record or Timeshift is running), ~~Info~~, red, green, yellow, blue, and ~~Move to the top~~ (or ~~Move to the bottom~~) options appear. 

 Select the [Move to the top](#) button to move the menu to the top.

 This function may not be supported depending on the geographical area.

- Underneath these two buttons are a round button and a large outer circle button. The round button is the Select button, and the large outer circle button consists of 4 directional buttons (up / down / left / right).
- Underneath the directional button are two buttons on the left and right hand sides and another button at the centre. The one on the left is the  button and the one on the right is the  button. The round button in the middle is the  button.
- If you press the  button while watching a TV programme, the screen you are watching stops and a control bar appears. You can select [Rewind](#), [Play](#), [Pause](#), [Fast Forward](#), [Stop Timeshift](#), [Record](#), [Go to Live TV](#), or [Info](#). You can press the up directional button to go to the playback screen and check the time that the actual broadcast programme is running and the timeshift time.

 You can use the [Slow Rewind](#) or [Slow Forward](#) functions when you select the [Pause](#) option.

 To use Record or Timeshift, you must connect a USB device.

 This function may not be supported depending on the model or geographical area.

- Underneath the  button are two thin horizontal buttons. These are more protruded than the other buttons on the remote control. The one on the left is the volume button and the one on the right is the channel button. Push up from beneath or down from above to use these as rocker buttons to change the channel or volume.
 - Briefly press the VOL button to mute the sound.
 - Press and hold the VOL button to open the [Accessibility Shortcuts](#) menu.
 - Briefly press the CH button to open the [Guide](#).
 - Press and hold the CH button to open the [Channel List](#).

 This function may not be supported depending on the model or geographical area.

Using the accessibility menu

View how to running the Accessibility menu functions and description of its functions.

 This function may not be supported depending on the model or geographical area.

Running the Accessibility Shortcuts menu

You can turn on or turn off the accessibility functions such as [Voice Guide](#), [Audio Description](#), [Subtitle](#), [High Contrast](#), [Enlarge](#), [Greyscale](#), [Colour Inversion](#), [Learn TV Remote](#), [Menu Learning Screen](#), [Multi-output Audio](#), [Sign Language Zoom](#), [Slow Button Repeat](#), and you can move to the [Learn TV Remote](#) and [Menu Learning Screen](#) pages.

- Samsung Smart Remote

On the Samsung Smart Remote, there are two thin horizontal rocker buttons next to each other located slightly below the middle of the remote. The one on the left is the volume button. Press and hold the volume button to open the [Accessibility Shortcuts](#) menu.

Even if the [Voice Guide](#) is set to [Off](#) or muted, when you press and hold the volume button, the voice guide for [Accessibility Shortcuts](#) is enabled.

 [Learn TV Remote](#) and [Menu Learning Screen](#) are only available when [Voice Guide](#) is set to [On](#).

- Standard remote control



Press the AD/SUBT. button or press and hold the MUTE button to open the [Accessibility Shortcuts](#) menu.

Running the Accessibility menu functions using the General menu

 >  **Settings** > **General** > **Accessibility**

You can also go to the **Accessibility** menu from the TV settings menu. This provides more options, for example, to change the speed of Voice Guide.



The TV will not verbalise this menu unless **Voice Guide** is already turned on.

1. Press the  button.
2. Press the left directional button until you reach  **Settings**.
3. Press the Select button to open the TV's **Settings** menu.
4. Press the down directional button to reach **General**, and then press the Select button to open this menu.
5. Use the directional buttons to go to the **Accessibility** menu, and then press the Select button to open this menu.
6. The menu will appear with **Voice Guide Settings** as the first selection. Highlight **Voice Guide Settings**, and then press the Select button.
7. A menu appears with the options to change **Voice Guide** and **Volume, Speed, Pitch**.
8. Select the menu using the directional buttons, and then press the Select button.



Running the Accessibility menu functions using Bixby

To use Bixby, the TV must be set up and tuned and must be connected to the Internet. You can connect the TV to the Internet during the initial setup or do it later through the settings menu.

There are many commands you can say to control the TV. These can be used together with **Voice Guide** to give you voice input and voice output. You can use the Samsung Smart Remote but the TV must be connected to the Internet.

To speak a command, press and hold the  button (located near the top of the Samsung Smart Remote, directly below the LED power indicator and above the directional button) and say the command, and then release the  button. The TV will confirm the command.

For example you can:

- Turn Voice Guide on
Press the  button on the Samsung Smart Remote and say "Voice Guide on".
- Turn Audio Description on
Press the  button on the Samsung Smart Remote, and then say "Audio Description on".
- Turn High Contrast on
Press the  button on the Samsung Smart Remote, and then say "High Contrast on".

Learning about the Accessibility menu functions

- **Voice Guide Settings**

This function works on every screen on the TV and when turned on verbally tells you what the TV's current settings are and verbally provides details about the programme you are watching. For example, it tells you the selected volume and the current channel and gives you programme information. It also reads out the programme information from the **Guide** screen.

- **Audio Description Settings**

You can activate an audio guide that provides an audio description of video scenes for the visually impaired. This function is only available with broadcasts that provide this service.

- **High Contrast**

To display all menus with an opaque black background and a white font, providing maximum contrast.

- **Greyscale**

You can change the colour of the TV screen to black and white to sharpen blurred edges caused by colours.

 If **Greyscale** is on, some **Accessibility** menus are not available.

 This function may not be supported depending on the model or geographical area.

- **Colour Inversion**

You can invert the colours of the text and background displayed on the TV screen to make it easier to read the text.

 If **Colour Inversion** is on, some **Accessibility** menus are not available.

 This function may not be supported depending on the model or geographical area.

- **Enlarge**

You can enlarge important elements on the menu such as the names of programmes.

- **Learn TV Remote**

Learn the names and functions of the buttons on remote control. On this screen, pressing the power button (top left button) will turn off the TV, but when any other button is pressed the TV will say the button name and briefly tell what that button does. This teaching mode helps you to learn the location and operation of the buttons on the remote without affecting normal TV operation. Press the button twice to exit **Learn TV Remote**.

- **Menu Learning Screen**

Learn the menus on the TV screen. Once enabled, your TV will tell you the structure and features of the menus you select.

- **Subtitle Settings**

You can view the subtitle in programmes that provide broadcast subtitles.

- **Multi-output Audio**

You can turn on both the TV speaker and Bluetooth headphone designed for the hearing impaired at the same time. The hearing impaired can then set the volume of their Bluetooth headphone higher than the volume of the TV speaker without affecting the volume of the TV speaker, allowing both the hearing impaired and their families to listen to the TV at comfortable sound levels.



When you connect the Bluetooth headphone to the TV, **Multi-output Audio** is activated.



This function may not be supported depending on the model or geographical area.

- **Sign Language Zoom Settings**

You can zoom in the sign language screen when the programme you are watching provides it.

- **Remote Button Repeat Settings**

You can configure the operation speed of the remote control buttons so that they slow down when you continually press and hold them.

Using the TV with Voice Guide on

Turn on Voice Guide that describes the menu options aloud to aid the visually impaired.

Changing channel

You can change the channel in three of ways. Every time you change channels, the new channel details will be announced. The ways to change the channel are below.



- **Channel List** ( > **Live TV** > **Channel List**)

Press the  button. The Smart Hub home screen appears. Use the left or right directional buttons to move to **Live TV**, press the up directional button to move to the top row, press the right directional button to move to **Channel List**, and then press the Select button. When **Channel List** is displayed, use the up or down directional buttons to move to the desired channel, and then press the Select button.

- **CH button**



Of the two buttons that protrude from the centre of the Samsung Smart Remote, the right one is the CH button. Push up or pull down the CH button to change the channel. Press the up or down of CH button on the standard remote control to change the channel.

- **Number button**

Use the  or  button on the Samsung Smart Remote to open the virtual numeric pad, enter a number, and then select **Done**. On the standard remote control, press the numeric buttons to enter a channel number.

Using on-screen number entry via the Samsung Smart Remote

Use the virtual numeric pad to enter numbers e.g. to enter a channel number or to enter a PIN.

Press the  or  button on the Samsung Smart Remote and the virtual numeric pad with 2 rows appears on screen. Voice Guide speaks “virtual numeric pad, 6” which indicates that the number strip is on screen and the focus is on the number 6. This strip has the following buttons:

- On the bottom row: From the far left: TTX, **1**, **2**, **3**, **4**, **5**, **6**, **7**, **8**, **9**, **0**, -(dash), **Delete**, **Move to the top** (or **Move to the bottom**)
- The top row has one option, **Done**.

 This function may not be supported depending on the model or geographical area.

Use the left and right directional buttons to move along the row, and then press the Select button to choose the numeric pad. When you have finished selecting all the numbers you need (for example, 123), press the up directional button to move to the **Done** option, and then press the Select button to finish.

When entering a channel number, you can enter the number, and then select the **Done** option on the top row or you can enter the channel number and wait. After a short while, the channel will change and the virtual number pad will disappear from the screen.

Changing volume

Point the Samsung Smart Remote at the remote control sensor of the TV, and then move the VOL button up or down to adjust the volume on the TV. Every time you change the volume, the new volume level will be announced.

- Samsung Smart Remote
Of the two buttons that protrude from the centre of the Samsung Smart Remote, the left one is the VOL button. Push up or pull down the VOL button to change the volume.
- Standard remote control
Press the VOL button on the standard remote control to adjust the volume.

Using programme information

When watching TV, press the Select button to view programme information which appears at the top of the screen. Voice Guide will say programme subtitles or audio descriptions if they are available. To view more detailed programme information, press and hold the Select button. Voice Guide will say more details such as a synopsis of the programme.

Press the left or right directional button to see what you can watch next on the same channel. Press the up or down directional button to move to other channels and see which programmes are currently being broadcast on them.

Press  to go back or close the programme details.

 This function may not be supported depending on the model or geographical area.

Using the guide

See an overview of each channel's programme lineup.

When you want to know the programme information for each channel while watching a broadcast programme, press the CH button on the Samsung Smart Remote. Use the directional buttons to view the programme information.

 On standard remote control, press the GUIDE button.



 > [Live TV](#) > [Guide](#)

You can see the daily programme schedules for each broadcaster and programme information in the [Guide](#). You can select programmes to schedule for viewing or recording.



You can also open the [Guide](#) using Bixby. Press and hold the  button on your Samsung Smart Remote, and then say "Guide".

 This function may not be supported depending on the model or geographical area.

 The information in the [Guide](#) is for digital channels only. Analogue channels are not supported.



 If the [Clock](#) is not set, the Guide is not provided. Set the [Clock](#) first. ( >  [Settings](#) > [General](#) > [System Manager](#) > [Time](#) > [Clock](#))

If you need to set the clock again, follow the instructions below.

1. Press the  button to open Smart Hub.
2. Press the left directional button to move to  [Settings](#).
3. Press the Select button to open the TV's [Settings](#) menu.
4. Use the up and down directional buttons to move to the [General](#) menu, and then press the Select button.
5. Use the up and down directional buttons to move to the [System Manager](#) menu, and then press the Select button.
6. Select the [Time](#) menu, and then press the Select button.
7. Select the [Clock](#) menu, and then press the Select button.
8. Select the [Clock Mode](#) menu, press the Select button, and then select [Auto](#) or [Manual](#).

 If you select [Manual](#), you can move to the [Date](#) or [Time](#) menu below to set the time.

When you open the **Guide**, a table grid of channels and programmes is displayed. The top row displays **Filter By : All** then the day and times. Each row has a channel name on the left and programmes on that channel on the right.

In the **Guide**, use the up and down directional buttons to move between channels and use the left and right directional buttons move to between programmes at different times within a channel. You can also use the  or  button to enter a channel number and go to that channel directly. You can use the  button to move to the programme currently broadcasting.

When you move the focus to a programme, you will hear the detailed information about the selected programme. When you move the focus to a different channel, you will hear the channel name and number, and the programme details. If you move to a different day, you will hear the day announced for the first programme you reach on that day. The day is not repeated, so if you are not sure what the day is, you can move forwards and backwards 24 hours and then the day will be announced.

To view a programme on now

In the **Guide**, move to the programme currently broadcasting, and then press the Select button to go to live TV on the selected channel and programme.

Other options in the guide

In the **Guide**, move to a broadcast scheduled programme, and then press the Select button. A pop-up menu listing the functions below appears.

Use the up and down directional buttons to move within this menu, and then press the Select button to choose an item. Press  to close the menu and go back to the **Guide**.

 For the programme you are currently watching, press and hold the Select button.

- **Record**

You can record the programme that you are currently watching or a programme on another channel.

 This function may not be supported depending on the model or geographical area.

- **Stop**

You can stop the recording function that is currently running.

- **Edit Recording Time**

You can change the start and end times of scheduled programme recordings.

 This function may not be supported depending on the model or geographical area.

- **Schedule Viewing**

You can schedule the viewing of a broadcast scheduled programme.

- **Schedule Recording**

You can schedule recording of a broadcast scheduled programme.

 This function may not be supported depending on the model or geographical area.

 For more information on [Schedule Recording](#), refer to "[Recording](#)".

- **Cancel Scheduled Viewing / Cancel Scheduled Recording**

You can cancel your scheduled viewings and recordings.

 This function may not be supported depending on the model or geographical area.

- **View Details**

You can see the detailed information on the selected programme. The information may differ with the broadcast signal. If the information is not provided with the programme, nothing appears.

Press the Select button on the [View Details](#) option. This will open the Details pop-up window for that programme which will display a synopsis. The details pop-up window contains detailed information and the [OK](#) option. After reading the detailed information, press the Select button on the remote control to close the pop-up window.

Using Schedule Viewing

Configure the TV to show a specific channel or programme at a specific time and date.

The  icon appears next to programmes that have been configured for a schedule viewing.

 To set up a schedule viewing, you must first set the TV's clock ( >  [Settings](#) > [General](#) > [System Manager](#) > [Time](#) > [Clock](#)).

Setting up a schedule viewing

You can set up a schedule viewing on two screens.

- **The Guide Screen**

On the [Guide](#) screen, select a programme you would like to view, and then press and hold the Select button. Select [Schedule Viewing](#) on the pop-up menu that appears.

- **The Programme Info Screen**

Press the Select button while watching the TV. The Programme Info window appears. Select a broadcast scheduled programme by using the left or right directional buttons, and then the Select button. You can schedule watching the programme by selecting [Schedule Viewing](#).

Cancelling a scheduled viewing

You have two ways to cancel a scheduled viewing.

- **Cancelling a scheduled viewing from the Guide**

In the [Guide](#) ( > [Live TV](#) > [Guide](#)), move to the programme for which you want to cancel scheduled viewing, and press the Select button. Move to [Cancel Scheduled Viewing](#), and then press the Select button. When a pop-up message asking you to cancel the selected schedule viewing appears, select [Yes](#). The selected scheduled viewing is cancelled and the screen returns to the [Guide](#) screen.

- Cancelling a scheduled viewing from Smart Hub
 1. Press the  button to open Smart Hub, and then press the left or right directional button to move to **Live TV**. Press the up directional button to move to the top row, and then press the left or right directional button to move to **Schedule Manager** or **Recordings**.
 2. Press the Select button to open **Schedule Manager** or **Recordings**.
 3. Press the up directional button to move to the **Schedules** menu.
 4. Use the down directional button to move to the list of programmes scheduled to view.
 5. Use the right directional button to move to the **Delete** option, and then press the Select button to delete the selected item.

 The menus may not appear depending on the model or geographical area.



Using the Channel List

See how to list the channels available on your TV.

> **Live TV** > **Channel List**

Using **Channel List**, you can change the channel or check programmes on other digital channels while watching TV.

Press the  button. The Smart Hub home screen appears. Use the left or right directional buttons to move to **Live TV**, press the up directional button to move to the top row, press the right directional button to move to **Channel List**, and then press the Select button. This shows a list of the channels and the programme currently on. The focus will be on the channel you are currently watching, showing channel name, channel number, and programme title.

Use the up and down directional buttons to move within the channel list (or use the CH button to go up and down a page at a time). You can also use the  or  button to enter a channel number and go to that channel directly.

Press the right directional button in the **Channel List** to move to the Category list. Use the up and down directional buttons to move within this list. Press the Select button to choose a category you want from the Category list. The Category list contains **All**, **Samsung TV Plus**, **Favourites** and **Terrestrial, Cable**, or **Satellite**. Use the up and down directional buttons to move to a channel you want to view, and then press the Select button.

- **All**
Displays the channels that have been automatically searched.

 The channels received to the currently selected **Terrestrial, Cable**, or **Satellite** are displayed.

- **Samsung TV Plus**

While the TV is connected to the Internet, you can watch popular programmes or highlights for each theme through a virtual channel at any time. As in a general channel, it provides the daily programme schedules of **Samsung TV Plus**.

- **Favourites**

Displays **Favourites 1** to **Favourites 5**. Use the up and down directional buttons to move between the lists of favourites. Highlight the one you want, and then press the Select button. The channel list will now show only the channels in this list.

- **Channel Type**

Sorts the list so that it includes channels of a selected type. However, **Channel Type** can only be used channels contain the type information.

 This function may not be supported depending on the incoming broadcast signal.

- **Sort**

Sorts the list by **Number** or by **Name**.

 This option is only available on digital channels and may not always be available.

- **Terrestrial, Cable, or Satellite**



Allows you to choose between **Terrestrial**, **Cable**, and **Satellite**.

 This function may not be supported depending on the incoming broadcast signal.

 This function may not be supported depending on the model or geographical area.

Recording

Recording a programme to an external hard drive connected via USB.



-  This function may not be supported depending on the model or geographical area.
-  Read all precautions before using the recording feature. For more information, refer to "[Before Using the Recording and Timeshift Functions](#)".

Using the instant and schedule recording options from the guide screen:



To record a programme that is on now, open the programme guide, move to the programme, and then press and hold the Select button. You will get a pop-up menu. Use the up and down directional buttons to move to **Record**. Press the Select button to record the programme. You will be returned to the programme guide. Recording automatically ends at the time when the programme ends.

To stop recording, press the down directional button while the programme being recorded is displayed. The control bar appears. Move the focus to **Stop Recording**, and then press the Select button. When a popup window appears, select **Stop**.

To record a programme that is on later, move to the required programme in the **Guide**, and then press and hold the Select button. You will get a pop-up menu. Use the up and down directional button to move within this menu. Move to the **Schedule Recording**, and then press and hold the Select button. You will hear a message saying the programme has been set to record and then you will return to the programme guide.

The  icon is placed visually against the programme title to show it is set to record. To find out if a programme is set to record or to cancel a scheduled recording press the Select button on the programme. If it is already set to record then the option on the menu will be **Cancel Scheduled Recording**. You can press the Select button to cancel the scheduled recording or just press  button to go back to the programme guide without cancelling the recording.

Recording the programme you are watching

To display a menu for recording a programme or starting the Timeshift function, press the  button twice or press the  button and then press the Select button while watching the programme. You can select the following functions on the menu:

- **Record**
Immediately starts to record the programme you are watching.
- **Timeshift**
Starts the Timeshift function.
- **Stop**
Stops the recording or the Timeshift function that is running.
- **Info**
Displays the details about the programme you are watching.

Scheduling recording from the programme info window

Press the Select button while viewing a programme to display the programme info window. In the programme info window, use the left and right directional buttons to select a broadcast scheduled programme, and then press the Select button. To schedule a recording for the programme, select **Schedule Recording**.

Changing the recording time

When recording a live programme you can specify how long you want to record for.

Press the down directional button to display the control bar at the bottom. Press the left or right directional buttons to move to **Edit Recording Time**, and then press the Select button. A slider scale appears and you will hear the recording time currently set. Use the left and right directional buttons to change the time, and then press the Select button. You will hear a menu that gives information about the recording time. To return to the programme you are watching, press the  button on the remote.

 The maximum recording time differs depending on the capacity of the USB device.

Viewing recorded programmes

 > [Live TV](#) > [Schedule Manager](#) or [Recordings](#) > [Recordings](#)

Open the Smart Hub by pressing the  button on the remote control. Use the left or right directional button to move the focus to [Live TV](#). Press the up directional button to move to the top row, and then use the left or right directional button to move to [Recordings](#).

To play a programme use the up and down directional buttons to move between programme titles and then you can press the Select button to play the programme or press the right directional button to move to a list of options. Use the up and down directional buttons to move between the options in this list to play the programme, delete it or view the programme details.

Select the [Play](#) option to play the programme. The programme will start. If you have watched part of this programme before, you will get a pop-up menu on screen allowing you to [Play](#) (from start), [Resume](#) (from where you left off) or [Cancel](#). Use the left and right directional buttons to move to the required option and press the Select button.

 This function may not be supported depending on the model or geographical area.

Deleting a recorded programme

To delete a recorded programme go to the list of [Recordings](#). Use the up and down directional buttons to move to the recording you want to delete.

Press the right directional button to move to a list of 3 options. Press the down directional button to move to the [Delete](#) option and press the Select button.











You will be asked if you want to remove the selected item. Press the left directional button to move to the [Delete](#) button and press the Select button to delete the programme title. The programme will be deleted and you will return to the list of [Recordings](#).

Using Smart Hub

Learn how to open Smart Hub to access apps, games, movies, and more.

Smart Hub

After pressing the  button on your remote control, you can surf the web and download apps with Smart Hub.

-  Some Smart Hub services are for pay services.
-  To use Smart Hub, the TV must be connected to the Internet.
-  Some Smart Hub features may not be supported depending on the service provider, language, or geographical area.
-  Smart Hub service outages can be caused by disruptions in your Internet service.
-  To use Smart Hub, you must agree to the Smart Hub service agreement and the collection and use of personal information. Without giving consent, you cannot use the additional features and services. You can view the entire text of the [Terms & Policy](#) by navigating to  >  [Settings](#) > [Support](#) > [Terms & Policy](#).
-  If you want to stop using Smart Hub, you can cancel the agreement. To cancel the Smart Hub service agreement though it is a required one, select [Reset Smart Hub](#) ( >  [Settings](#) > [Support](#) > [Self Diagnosis](#) > [Reset Smart Hub](#)).

Press the  button on your remote. This will bring up a display with 2 rows. Try moving the focus to [Live TV](#) or another item on the bottom row. The options on the top row change depending on the item selected in the bottom row.

The buttons to the right of [Live TV](#) provide quick access to apps such as [Netflix](#) and [Prime Video](#).

Use the left and right directional buttons to move between a menu or apps on a row and the up and down directional buttons to move between rows. Press the Select button to access a menu or apps.



When the Smart Hub home screen appears, use the left or right directional button to move the focus to [Live TV](#) or [Samsung TV Plus](#). Press the up directional button to move to the top row. You will be on the [Guide](#) item. The items in this row may include [Guide](#), [Channel List](#), [Schedule Manager](#), [Recordings](#), and others.

Using the Smart Hub home screen

At the leftmost part of the Smart Hub home screen is the static menu listed below. You can quickly and easily use the listed menu items to access the main TV settings or external devices, search, and apps.

-  **Notification**

You can view a list of notifications for all events that occur on your TV. A notification appears on the screen when a scheduled programme is about to be broadcast or when an event occurs on a registered device.

If you move the focus to **Notification**, and then press the Select button, a notification window appears on the right containing the following functions,  **Delete All** and  **Settings**.

-  **Settings**

When the focus is moved to **Settings**, a list of quick settings icons appears above the top of the menu. You can quickly set frequently used functions by clicking the icons. You can set **e-Manual**, **Intelligent Mode**, **Picture Mode**, **Sound Mode**, **Sound Output**, **Game Mode**, **Audio Language**, **Subtitle**, **PIP**, **Network**, **Picture Size**, **Colour Tone**, **Auto Motion Plus**, **Contrast Enhancer**, **Digital Output Audio Format**, **Colour Space**, and **TV Device Manager**.

 This function may not be supported depending on the model or geographical area.

-  **Source**

You can select an external device connected to the TV.

 For more information, refer to "[Switching between external devices connected to the TV](#)".

-  **Search**

A Virtual keyboard appears on the screen, and you can search for channels, titles of movies, or apps provided by the Smart Hub service.

 To use this feature, the TV must be connected to the Internet.

-  **APPS**



You can enjoy a wide range of content including news, sports, weather, and games by installing the corresponding apps on your TV.

 To use this feature, the TV must be connected to the Internet.

 For more information, refer to "[Using the APPS Service](#)".

-  **Ambient Mode**

You can enhance your living space with decorative content that matches the surroundings or view essential real-time information such as weather, time, and news on the TV screen when you are not watching TV.

To enter **Ambient Mode**, press the  button. To return to the TV mode, press the  button. To shut off the TV, press the  button.

If you press the  button when the TV is turned off, the TV turns on in **Ambient Mode**.

 If you use a remote control other than the Samsung Smart Remote, there may be restrictions to entering **Ambient Mode**.

 Because this function is specific to QLED and SERIF TVs, it may not be supported depending on the model.

 For more information about the **Ambient Mode**, refer to "[Using the Ambient Mode](#)".

-  **Universal Guide**

Universal Guide is an app that allows you to search for and enjoy various content such as TV shows, dramas, and movies in one place. **Universal Guide** can recommend content tailored to your preferences.

 For more information about **Universal Guide**, refer to "[Using the Universal Guide App](#)".

 Images may look blurry depending on the service provider's circumstances.

 This function may not be supported depending on the model or geographical area.

-  **Art**



When you are not watching TV or when the TV is turned off, you can use the Art mode function to edit image content such as artworks or photos or to display the content.

 This function is supported only in THE FRAME model.

 For more information, refer to the provided user manual.

Launching the e-Manual

Open the user manual embedded in your TV.

Press the  button to open Smart Hub, press the left directional button to move to  **Settings**, and then press the Select button.

Use the up and down directional buttons to move to **Support**, and then select **Open e-Manual** to open the e-Manual.



 >  **Settings** > **Support** > **Open e-Manual**

You can view the embedded e-Manual containing information about your TV's key features.

 Alternatively, you can download a copy of the e-Manual from Samsung's website (<http://www.samsung.com>).

 Words in blue (e.g., **Internet**) indicate a menu item.

The e-Manual contains 2 rows of menu icons. Use the up and down directional buttons to move between rows and the left and right directional buttons to move within a row. Press the Select button to open the section you want to read.

The e-Manual contains a section called "Learn TV Remote" in the "Accessibility Guidance" (at the right corner of the screen). This is particularly useful for people who cannot easily see the buttons on the control or who are not clear what each button does. When you are viewing this section of the e-Manual, pressing the buttons on the remote control will not affect the TV. Note that the "Accessibility Guidance" item is only available when **Voice Guide** ( >  **Settings** > **General** > **Accessibility** > **Voice Guide Settings** > **Voice Guide**) is enabled.

Using Bixby

A guide to using Bixby to control your TV.

To use Bixby, your TV must be connected to the Internet and you must use the microphone on your Samsung Smart Remote.

To use Bixby, press and hold the  button on the Samsung Smart Remote, say a command into the microphone on the remote, and then release the button to run Bixby.

 The existing functional specifications may be changed if Bixby is updated.



Running Bixby

Press and hold the  button on the Samsung Smart Remote. Bixby is activated in the listening mode, the Bixby icon appears at the bottom of the TV screen. Say a command, and then release the button. The TV provides feedback on how it understands the command, and then performs the commanded task.

 If the TV does not understand the command, try again with more precise pronunciation.

 This function may not be supported depending on the model or geographical area.

 The supported language may differ depending on the geographical area.

 You can find a detailed description of the voice commands at [Explore Bixby](#). Press the  button. The [Explore Now](#) button appears at the bottom of the screen. Press the Select button to go to the [Explore Bixby](#) screen.