

# SIEMENS

WR47B2CSGB

# Tumble dryer



**EN** User manual and installation instructions



Siemens Home Appliances

Register your appliance on My Siemens and  
discover exclusive services and offers.



**You can find additional information and explanations online.  
Scan the QR code on the title page.**



## Table of contents

<b>1 Safety .....</b>	<b>3</b>	10.1 Preparing the laundry .....	22
1.1 General information .....	3	10.2 Care symbols on the care labels .....	22
1.2 Intended use .....	4	<b>11 Basic operation .....</b>	<b>23</b>
1.3 Restriction on user group .....	4	11.1 Switching on the appliance ..	23
1.4 Safe installation .....	4	11.2 Setting a programme .....	23
1.5 Safe use .....	6	11.3 Saving the programme settings .....	23
1.6 Safe cleaning and maintenance .....	9	11.4 Opening the door .....	23
<b>2 Preventing material damage .....</b>	<b>9</b>	11.5 Loading laundry .....	23
<b>3 Environmental protection and saving energy .....</b>	<b>10</b>	11.6 Starting the programme .....	24
3.1 Disposing of packaging .....	10	11.7 Adding laundry .....	24
3.2 Saving energy .....	10	11.8 Cancelling the programme ...	24
3.3 Energy saving mode .....	10	11.9 Unloading the laundry .....	24
<b>4 Installation and connection .....</b>	<b>11</b>	11.10 Put the appliance into standby mode .....	24
4.1 Unpacking the appliance .....	11	11.11 Fluff filter .....	24
4.2 Contents of package .....	11	11.12 Condensation container .....	26
4.3 Requirements for the installation location .....	11	<b>12 Dryness level .....</b>	<b>26</b>
4.4 Water outlet hose .....	12	12.1 Changing the dryness level ..	27
4.5 Aligning the appliance .....	13	12.2 Adjusting the dryness level ...	27
4.6 Reversing the door .....	13	<b>13 Childproof lock .....</b>	<b>27</b>
4.7 Connecting the appliance to the electricity supply .....	13	13.1 Activating the childproof lock .....	27
<b>5 Familiarising yourself with your appliance .....</b>	<b>14</b>	13.2 Deactivating the childproof lock .....	27
5.1 Appliance .....	14	<b>14 Crease-removal function .....</b>	<b>27</b>
5.2 Control panel .....	15	14.1 Starting a programme with the crease-removal function .....	28
5.3 Operating logic .....	15	14.2 Filling the water tank .....	28
<b>6 Display .....</b>	<b>15</b>	<b>15 Drying basket .....</b>	<b>29</b>
<b>7 Buttons .....</b>	<b>17</b>	15.1 Inserting a drying basket .....	29
<b>8 Programmes .....</b>	<b>19</b>	15.2 Starting a programme with the drying basket .....	29
8.1 Automatic programmes .....	19	15.3 Examples of how to use the drying basket .....	29
8.2 Timed programmes .....	21		
<b>9 Accessories .....</b>	<b>21</b>		
<b>10 Laundry .....</b>	<b>22</b>		

<b>16 Home Connect</b> .....	<b>30</b>	18.3 Running the intensive appliance care programme .....	34
16.1 Setting up Home Connect .....	30	<b>19 Cleaning and servicing</b> .....	<b>34</b>
16.2 Deactivating Wi-Fi on the appliance .....	30	19.1 Moisture sensor .....	34
16.3 Activating Wi-Fi on the appliance .....	30	19.2 Door grille .....	35
16.4 Installing the software update .....	31	<b>20 Troubleshooting</b> .....	<b>35</b>
16.5 Resetting the appliance network settings .....	31	<b>21 Transportation, storage and disposal</b> .....	<b>39</b>
16.6 Remote start .....	31	21.1 Emptying the base unit .....	39
16.7 Intelligent programme recommendation .....	31	21.2 Disposing of old appliance ...	39
16.8 Remote diagnostics .....	31	<b>22 Customer Service</b> .....	<b>40</b>
16.9 Data protection .....	32	22.1 Product number (E-Nr.), production number (FD) and consecutive numbering (Z-Nr.) .....	40
<b>17 Basic settings</b> .....	<b>32</b>	<b>23 Consumption values</b> .....	<b>40</b>
17.1 Overview of the basic settings .....	32	<b>24 Technical data</b> .....	<b>42</b>
17.2 Changing the basic settings .....	33	24.1 Information regarding Free and Open Source Software ..	43
<b>18 Appliance care</b> .....	<b>33</b>	<b>25 Declaration of Conformity</b> .....	<b>44</b>
18.1 Preparing for appliance care .....	33	25.1 Statement of Compliance for Great Britain .....	44
18.2 Running the basic appliance care programme .....	33		

## 1 Safety

Observe the following safety instructions.

### 1.1 General information

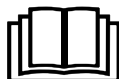

- Read this instruction manual carefully.
- Keep the instruction manual and the product information safe for future reference or for the next owner.
- Do not connect the appliance if it has been damaged in transit.

## 1.2 Intended use

Only use this appliance:

- for drying and freshening up fabrics that are washed with water and suitable for dryers.
- in private households and in enclosed spaces in a domestic environment.
- Up to an altitude of 4000 m above sea level.

## 1.3 Restriction on user group

This appliance may be used by children aged 8 or over and by people who have reduced physical, sensory or mental abilities or inadequate experience and/or knowledge, provided that they are supervised or have been instructed on how to use the appliance safely and have understood the resulting dangers.

Do not let children play with the appliance.

Cleaning and user maintenance must not be performed by children unless they are being supervised.

Keep children under the age of 3 years and pets away from the appliance.

## 1.4 Safe installation

### **WARNING – Risk of electric shock!**

Incorrect installation is dangerous.

- ▶ Connect and operate the appliance only in accordance with the specifications on the rating plate.
- ▶ Connect the appliance to a power supply with alternating current only via a properly installed socket with earthing.
- ▶ The protective conductor system of the domestic electrical installation must be properly installed. The installation must have a sufficiently large cross section.
- ▶ When using a residual current circuit breaker, only use a type with the  mark.
- ▶ Never equip the appliance with an external switching device, e.g. a timer or remote control.
- ▶ Never connect the appliance to a circuit that is regularly switched on and off by the energy supplier.

- ▶ When the appliance is installed, the mains plug of the power cord must be freely accessible. If free access is not possible, an isolating switch must be integrated into the permanent electrical installation according to the installation regulations.
- ▶ When installing the appliance, check that the power cable is not trapped or damaged.

If the insulation of the power cord is damaged, this is dangerous.

- ▶ Never let the power cord come into contact with hot appliance parts or heat sources.
- ▶ Never let the power cord come into contact with sharp points or edges.
- ▶ Never kink, crush or modify the power cord.

### **⚠ WARNING – Risk of fire!**

It is dangerous to use an extended power cord and non-approved adapters.

- ▶ Do not use extension cables or multiple socket strips.
- ▶ Only use adapters and power cords approved by the manufacturer.
- ▶ If the power cord is too short and a longer one is not available, please contact an electrician to have the domestic installation adapted.

### **⚠ WARNING – Risk of injury!**

The heavy weight of the appliance may result in injury when lifted.

- ▶ Do not lift the appliance on your own.
- If this appliance is not correctly installed in a washer-dryer stack, the installed appliance may fall.
- ▶ Only stack the dryer on a washing machine using the connection kit from the dryer manufacturer . No other installation method is permitted.
  - ▶ Do not install the appliance in a washer-dryer stack if the dryer manufacturer does not offer a suitable connection kit.
  - ▶ Do not install appliances from different manufacturers in a washer-dryer stack. Only install appliances with varying depths and widths in a washer-dryer stack if the connection kit allows this.
  - ▶ Do not install a washer-dryer stack on a platform; the appliances may tip over.

**⚠ WARNING – Risk of suffocation!**

Children may put packaging material over their heads or wrap themselves up in it and suffocate.

- ▶ Keep packaging material away from children.
- ▶ Do not let children play with packaging material.

**⚠ CAUTION – Risk of injury!**

The appliance may vibrate or move when in use.

- ▶ Place the appliance on a clean, even, solid surface.
- ▶ Align the appliance using the appliance feet and a spirit level. If hoses and power cords have been laid incorrectly, this causes a tripping hazard.
- ▶ Lay hoses and power cords in such a way that there is no risk of tripping.

If the appliance is moved by holding onto protruding components, such as the appliance door, the parts may break off.

- ▶ Do not move the appliance by holding onto protruding parts.

**⚠ CAUTION – Risk of cutting!**

Touching sharp edges on the appliance may lead to cuts.

- ▶ Do not touch the sharp edges on the appliance.
- ▶ Wear protective gloves when installing and transporting the appliance.

## 1.5 Safe use

**⚠ WARNING – Risk of electric shock!**

If the appliance or the power cord is damaged, this is dangerous.

- ▶ Never operate a damaged appliance.
- ▶ Never pull on the power cord to unplug the appliance. Always unplug the appliance at the mains.
- ▶ If the appliance or the power cord is damaged, immediately unplug the power cord or switch off the fuse in the fuse box.
- ▶ Call customer service. → *Page 40*

An ingress of moisture can cause an electric shock.

- ▶ Only use the appliance in enclosed spaces.
- ▶ Never expose the appliance to intense heat or humidity.
- ▶ Do not use steam- or high-pressure cleaners, hoses or sprays to clean the appliance.

**⚠ WARNING – Risk of harm to health!**

Children can lock themselves in the appliance, thereby putting their lives at risk.

- ▶ Do not install the appliance behind a door as this may obstruct the appliance door or prevent it from opening.
- ▶ With redundant appliances, unplug the power cord. Then cut through the cord and damage the lock on the appliance door beyond repair so that the appliance door will no longer close.

**⚠ WARNING – Risk of suffocation!**

Children may breathe in or swallow small parts, causing them to suffocate.

- ▶ Keep small parts away from children.
- ▶ Do not let children play with small parts.

**⚠ WARNING – Risk of explosion!**

If there is coal dust or flour in the air around the appliance, this may cause an explosion.

- ▶ Keep the area around the appliance clean during operation.

**⚠ WARNING – Risk of poisoning!**

Condensation water from this appliance is not suitable for drinking and may be contaminated with fluff.

- ▶ Do not drink or reuse the condensation water from the appliance.

Detergents and care products may result in poisoning if consumed.

- ▶ If accidentally swallowed, seek medical advice.
- ▶ Keep detergents and care products out of the reach of children.

**⚠ WARNING – Risk of fire!**

The refrigerant R290 in this appliance is environmentally friendly yet combustible and may ignite if it comes into contact with open flames or ignition sources.

- ▶ Keep naked flames and ignition sources away from the appli-

ance.



**⚠ WARNING – Risk of explosion!**

If there is any residual material left in the fluff filter, this may ignite during the drying process.

- ▶ Clean the fluff filter regularly.

Highly flammable objects such as lighters or matches may ignite during the drying process.

- ▶ Remove all highly flammable objects from any pockets in your laundry before the drying process.

Unwashed laundry that has come into contact with solvents, oil, wax, wax remover, paint, grease or stain remover may ignite when drying is in progress.

- ▶ Do not place laundry in this appliance to be dried if the laundry has not been washed first.
- ▶ Rinse the laundry thoroughly with warm water and detergent before drying it in the machine.
- ▶ Do not use the appliance if industrial chemicals have been used to clean the laundry beforehand.

**⚠ WARNING – Risk of fire!**

If drying is interrupted early, the laundry is not cooled sufficiently and may ignite.

- ▶ Do not interrupt the drying programme early.
- ▶ If drying is interrupted early, remove the laundry immediately and spread it out.

**⚠ CAUTION – Risk of injury!**

The covering plate may break if you stand on or climb onto the appliance.

- ▶ Do not stand on or climb onto the appliance.

The appliance may tip over if you sit on or lean against the open door.

- ▶ Do not sit on or lean against the appliance door.
- ▶ Do not place any objects on the appliance door.

Reaching into the drum while it is still turning may cause hand injuries.

- ▶ Wait for the drum to come to a complete stop before reaching inside.



## 1.6 Safe cleaning and maintenance

### ⚠ **WARNING – Risk of electric shock!**

Improper repairs are dangerous.

- ▶ Never make any technical modifications to the appliance or its features.
- ▶ Repairs to the appliance should only be carried out by trained specialist staff.
- ▶ Only use genuine spare parts when repairing the appliance.
- ▶ If the power cord of this appliance is damaged, it must be replaced by the manufacturer, the manufacturer's Customer Service or a similarly qualified person in order to prevent any risk.

An ingress of moisture can cause an electric shock.

- ▶ Before cleaning, pull out the mains plug or switch off the fuse in the fuse box.
- ▶ Do not use steam- or high-pressure cleaners, hoses or sprays to clean the appliance.

### ⚠ **WARNING – Risk of injury!**

The use of non-original spare parts and non-original accessories is dangerous.

- ▶ Only use the manufacturer's original spare parts and original accessories.

### ⚠ **WARNING – Risk of poisoning!**

Poisonous fumes may be given off if you use cleaning agents that contain solvents.

- ▶ Do not use cleaning agents that contain solvents.

---

## 2 Preventing material damage

### **ATTENTION**

The functionality of the appliance may be impaired if you use the wrong quantity of fabric softener, detergent, care product or cleaning agent.

- ▶ Follow the dosage recommendations from the manufacturer.

Exceeding the maximum load capacity impairs the function of the appliance.

- ▶ Observe the maximum load capacity for each programme and do not exceed it.

→ *"Programmes", Page 19*

The function of the appliance may be impaired if the appliance overheats.

- ▶ Keep the ventilation opening on the appliance clear during operation.

- ▶ Make sure that the area is adequately ventilated.

Light objects such as hair and fluff may be sucked in from the ventilation opening on the appliance during operation and impair the function of the appliance.

- ▶ Keep the area around the appliance clean during operation.
- ▶ Keep light objects away from the appliance.

If you operate the appliance without a fluff guard (e.g. fluff filter, fluff collector, filter mat, etc., depending on appliance specifications), or if the fluff guard is incomplete or defective, this may result in damage to the appliance.

- ▶ Do not operate the appliance without a fluff guard, or with a fluff guard that is incomplete or defective.

Foam and foam rubber may deform or melt during the drying process.

- ▶ Do not dry laundry that contains foam or foam rubber.

Unsuitable cleaning products may damage the surfaces of the appliance.

- ▶ Do not use harsh or abrasive detergents.
- ▶ Do not use cleaning products with a high alcohol content.
- ▶ Do not use hard scouring pads or cleaning sponges.
- ▶ Clean the appliance with nothing but water and a soft, damp cloth.
- ▶ Remove all detergent residue, spray residue or other residues immediately if they come into contact with the appliance.

---

## 3 Environmental protection and saving energy

### 3.1 Disposing of packaging

The packaging materials are environmentally compatible and can be recycled.

- ▶ Sort the individual components by type and dispose of them separately.

### 3.2 Saving energy

If you follow these instructions, your appliance will use less power.

- Operate the appliance in a well-ventilated room and keep the ventilation opening on the appliance clear.
- Spin the laundry in the washing machine before drying.
- For each drying process, use the maximum load for the programs. Programmes → *Page 19*
- Do not exceed the programme's maximum load capacity. Programmes → *Page 19*
- After drying, clean the fluff filter. → *"Cleaning the fluff filter", Page 24*
- Deactivate Wi-Fi on the appliance if it is not being used. → *"Deactivating Wi-Fi on the appliance", Page 30*

### 3.3 Energy saving mode

If you do not use the appliance for a brief period, it automatically switches to energy-saving mode. All displays go out and ▷ flashes.

Energy-saving mode ends when you use the appliance again.

If you do not use the appliance for an extended period, it automatically switches to standby mode.

## 4 Installation and connection

### 4.1 Unpacking the appliance

#### ATTENTION

Objects remaining in the drum that are not designed for operation with the appliance may cause material damage and damage to the appliance.

- ▶ Remove these objects, along with all supplied accessories, from the drum before starting the appliance.
- 1. Remove any packaging and protective covers completely from the appliance.  
→ *"Disposing of packaging"*, Page 10
- 2. Check the appliance for visible damage.
- 3. Open the door. → *Page 23*
- 4. Remove any accessories from the drum.
- 5. Close the door.

### 4.2 Contents of package

After unpacking all parts, check for any damage in transit and completeness of the delivery.

#### ATTENTION

If the appliance is operated with incomplete or defective accessories, the appliance may not be able to operate properly, or this may result in material damage or damage to the appliance.

- ▶ Do not operate the appliance with incomplete or defective accessories.
- ▶ Replace the accessories in question before operating the appliance.  
→ *"Accessories"*, Page 21

The delivery consists of the following:

- Tumble dryer
- Accompanying documents
- Water jug → *Page 28*
- Drying basket → *Page 29*

### 4.3 Requirements for the installation location

Observe the instructions for the installation location.

#### ATTENTION

If the appliance is tilted at an angle greater than 40°, residual water may leak out of the appliance and cause material damage.

- ▶ Tilt the appliance carefully.
- ▶ Transport the appliance in an upright position.

If residual water in the appliance freezes, this may cause damage to the appliance.

- ▶ Do not install or operate this appliance anywhere that is liable to experience frost or outdoors.

If the appliance is operated immediately after transportation, the refrigerant contained in the appliance may result in damage to the appliance.

- ▶ Immediately after transporting the appliance, leave it to rest for two hours before putting it into operation.

#### On the floor

Place the appliance on a clean, level and firm surface.

Align the appliance. → *Page 13*

#### In a washer-dryer stack

Only use the original connection set from the dryer manufacturer when setting up this appliance in a washer-dryer stack.

- Connection kit with pull-out work-top → *Page 22*

This appliance must only be stacked on a washing machine from the same manufacturer. The depth and width of this appliance must correspond with the dimensions of the washing machine, unless the connection kit allows for varying dimensions. Do not place the washer-dryer stack on a platform.

### Against a wall

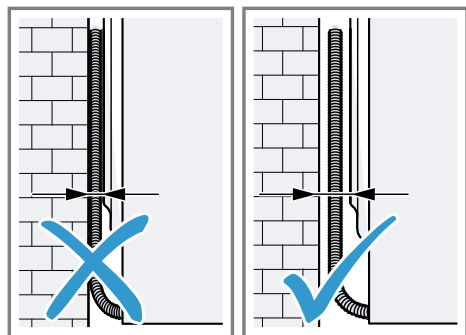

Do not trap the hoses and power cord between the wall and the appliance.

## 4.4 Water outlet hose

Condensation that forms in the appliance as it dries the laundry is collected by default in the condensation container. Use the water outlet hose to drain away excess condensation directly into the waste water system.

### Connecting the water outlet hose

If you do not want to regularly empty the appliance's condensation container, connect the water outlet hose.

#### ATTENTION

When operating the appliance without the water outlet hose being connected properly, liquid may leak out.

- ▶ Before operating the appliance, ensure that the water outlet hose is properly connected.

## Requirements

- The appliance and the accessory have been unpacked. → *Page 11*
  - The appliance is installed at the installation location.
1. Empty the condensation container. → *Page 26*
  2. Insert the condensation container. → *Page 26*
  3. Disconnect the hose clamp on the water outlet hose on the rear of the appliance and pull the water outlet hose out of the condensation container.

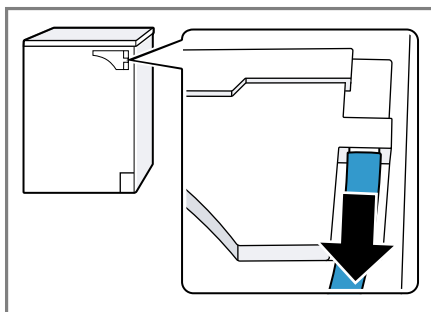

4. Connect the water outlet hose to the water outlet. → *Page 12*

**Tip:** To collect condensation in the condensation container again (e.g. if you change where the appliance is located), carry out these steps in reverse order.

### Water outlet connection types

#### ATTENTION

In the event of a blocked or covered outlet, accumulated wastewater can flow back into the appliance.

- ▶ Before operating the appliance, ensure that the wastewater drains away quickly and eliminate any blockages.

Drainage into a siphon.

Secure the connection point with a (12-22 mm) hose clamp.

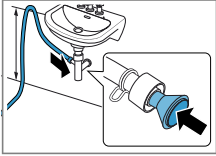

Secure the water outlet hose with a hose guide at a height of at least 80 cm and no more than 100 cm.

**Note:** You can use the Y-distributor → *Page 22* to connect the water outlet hose of an additional appliance, such as a washing machine, to the same siphon outlet.

Drainage into a wash basin.

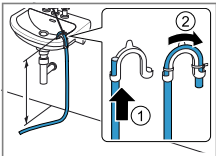

Push the water outlet hose fully through the elbow and secure it using fixing material. Secure the elbow at a height of no more than 100 cm.

Drainage into a gully.

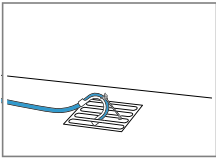

Push the water outlet hose fully through the elbow and secure it using fixing material. Secure the elbow to the gully.

## 4.5 Aligning the appliance

In order to reduce vibrations and noises, align the appliance correctly.

- ▶ To align the appliance, turn the appliance feet. Check that the appliance is level using a spirit level.

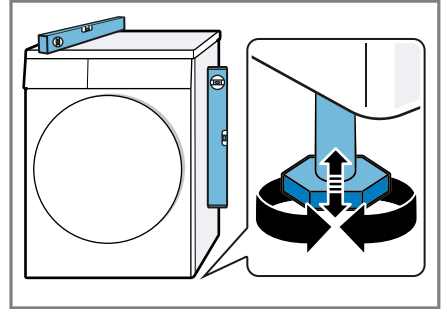

All appliance feet must stand firmly on the ground.

## 4.6 Reversing the door

**Note:** You can find more information about changing the door direction online. Scan the QR code on the title page.

## 4.7 Connecting the appliance to the electricity supply

1. Insert the mains plug of the appliance's power cable in a socket nearby.  
The connection details of the appliance can be found under Technical data → *Page 42*.
2. Check the mains plug is inserted properly.
  - ✓ The appliance is now ready for use.

## 5 Familiarising yourself with your appliance

### 5.1 Appliance

You can find an overview of the parts of your appliance here.

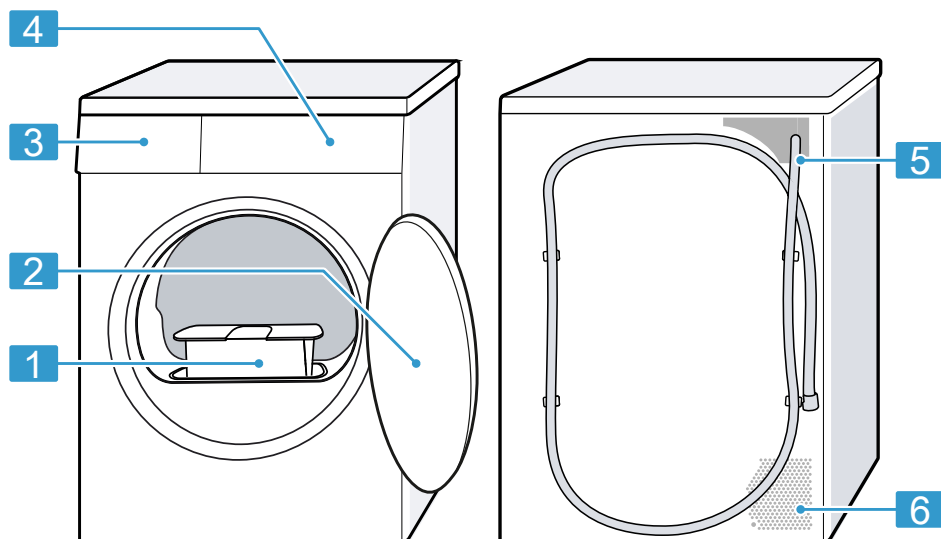

On certain models, specific details such as the colour and shape may differ from those pictured.

---

**1** Fluff filter → *Page 24*

---

**2** Door → *Page 23*

---

**3** Condensation container  
→ *Page 26*

---

---

**4** Control panel → *Page 15*

---

**5** Water outlet hose → *Page 12*

---

**6** Ventilation opening

---

## 5.2 Control panel

You can use the control panel to configure all functions of your appliance and to obtain information about the operating status.

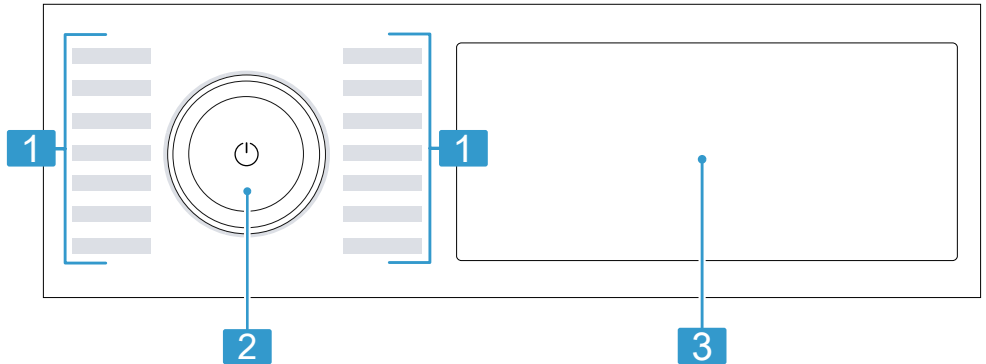

**1** Programmes → *Page 19*

**2** Programme selector  
→ *Page 23*

**3** Buttons → *Page 17* and display  
→ *Page 15*

### ATTENTION

Pressing on the display with force may cause damage.

- ▶ Do not apply heavy pressure on the display.
- ▶ Do not press on the display using pointed or sharp objects.

## 5.3 Operating logic

Some areas of the display are buttons and respond to touch. You can activate, deactivate or change settings by pressing the buttons. The activated settings are highlighted in colour on the display.

### Changing a setting value

If you activate certain settings, the display shows selection buttons and you can change the setting value.

- ▶ Press the selection buttons  
→ *Page 18*.  
The display shows the setting value.

## 6 Display

The display shows the current settings, options or relevant information. Depending on the programme status, the display shows some information in the **88:88** area, e.g. **E n d**.

**Note:** Additional functions may be available as a result of software updates.  
→ *Page 31*

If a software update is available, you can find further information in the Home Connect app.

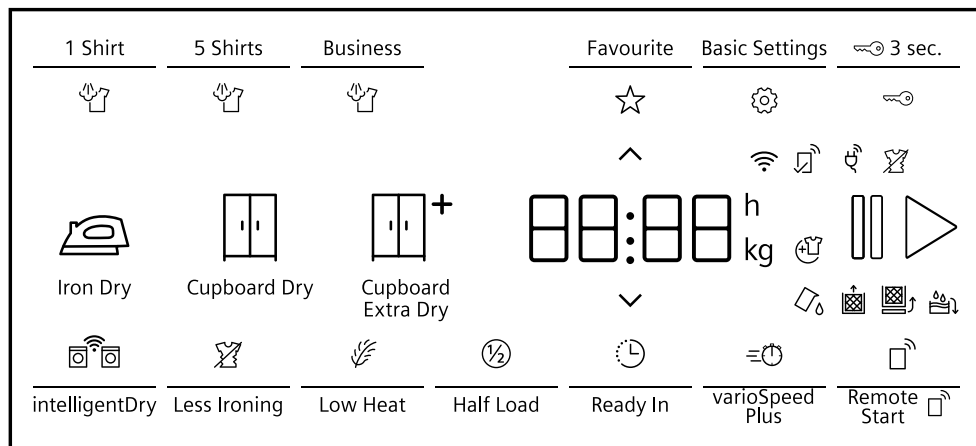











Example: Display

Indicator	Description
0:40 <sup>1</sup>	Expected programme duration or programme time remaining in hours and minutes.
9.0 <sup>1</sup>	Recommendation for the maximum load capacity for the selected program in kg.
🕒 10h <sup>1</sup>	Programme end time → <i>Page 19</i>
⏸	Shortened programme duration is activated. → <i>Page 18</i>
★	Save a programme. → <i>"Buttons", Page 18</i>
🔒	<ul style="list-style-type: none"> <li>■ Lights up: The childproof lock is activated.</li> <li>■ Flashes: The childproof lock is activated and the appliance has been operated. → <i>Page 27</i></li> </ul>
🔪	The dryness level is activated. → <i>Page 26</i>
🗄	The dryness level is activated. → <i>Page 26</i>
🗄+	The dryness level is activated. → <i>Page 26</i>
🌀	The crease-reduction function is activated. → <i>"Buttons", Page 18</i>
🌿	Gentle drying is activated for delicate fabrics. → <i>Page 18</i>
🕒	Half load is activated. → <i>Page 19</i>
🕒	You can remove or add laundry, and interrupt the current programme. → <i>Page 24</i>

<sup>1</sup> Example



















Indicator	Description
	Empty and insert the condensation container. → <i>Page 26</i>
	Clean the fluff filter → <i>Page 24</i> .
CArE	Run the basic appliance care programme. → <i>Page 33</i>
	Fill the water tank for the crease-removal function. → <i>Page 28</i>
Hot	The cooling process cools the laundry independently of the programme status for a few minutes while the drum is rotating, in order to avoid damage to the laundry. The cooling process can be cancelled by opening the door. <b>Note:</b> Do not change the set programme.
	Change the basic settings. → <i>Page 33</i>
	Intelligent programme recommendation is activated. → <i>Page 19</i>
	<ul style="list-style-type: none"> <li>■ Lights up: The appliance is connected to your home network via Wi-Fi.</li> <li>■ Flashes: The appliance is trying to connect to your home network via Wi-Fi.</li> </ul>
	Remote start is activated. → <i>Page 19</i>
	Settings that are not available on the appliance have been set via the Home Connect app. You can find more information in the Home Connect app.
	Programme status: Crease-reduction function
	Programme status: Pause
End	Programme status: Programme end

## 7 Buttons

**Note:** Additional functions may be available as a result of software updates.  
→ *Page 31*

If a software update is available, you can find further information in the Home Connect app.

Button	Description
	Start, cancel or pause the programme. If  is displayed, you can pause the programme. If  is displayed, you can start the programme.
	Switch on the appliance or put it in standby mode.

Button	Description
	If the control panel does not respond, press and hold  for approximately 5 seconds to restart the appliance. → <i>Page 36</i>
 3 sec.	Activate or deactivate the childproof lock. → <i>Page 27</i>
 	Changing settings. → <i>Page 15</i>
Basic Settings	Call up the basic settings. → <i>Page 32</i>
Favourite	Press the button for approx. 3 seconds to save your customised programme settings. → <i>Page 23</i> If you briefly press the button, you set your saved programme with individual programme settings.
Cupboard Extra Dry 	Change the dryness level. → <i>Page 26</i>
Cupboard Dry 	Change the dryness level. → <i>Page 26</i>
Iron Dry 	Change the dryness level. → <i>Page 26</i>
5 Shirts 	Adjust the smartFinish  programme. Observe the programme description. → <i>Page 19</i> Suitable for dry shirts and blouses that have not been worn for long or at all. Suitable for 2 to 5 items of laundry.
Business 	Adjust the smartFinish  programme. Observe the programme description. → <i>Page 19</i> Suitable for dry suits or skirts that have not been worn for long or at all and that are labelled "Dry clean only". Suitable for one suit or two items of laundry.
1 Shirt 	Adjust the smartFinish  programme. Observe the programme description. → <i>Page 19</i> Suitable for dry shirts and blouses that have not been worn for long or at all. Suitable for one item of laundry.
Less Ironing	Activate or deactivate the crease-reduction function. Once the programme has ended, the drum moves the laundry at regular intervals for 120 minutes to prevent creasing.
varioSpeed Plus	Activate or deactivate a shorter programme duration. <b>Note:</b> Energy consumption and noise emissions increase. This does not impair the drying result.
Low Heat	Activate or deactivate gentle drying. The temperature is reduced for delicate fabrics, e.g. polyacrylic or elastane.

Button	Description
	The programme duration is extended.
Ready In	Set the programme end time. The programme duration is already included in the set number of hours. Once the programme has started, the programme duration is displayed.
Half Load	Dry individual items of laundry or small loads of laundry.
intelligentDry	Activate or deactivate intelligent programme recommendation. → <i>Page 31</i>
Remote Start 	If you press the button briefly, you can activate or deactivate remote start. → <i>Page 31</i> If you press and hold the button for approx. 3 seconds, the Home Connect settings open. → <i>Page 30</i>

## 8 Programmes

You can dry your fabrics using either an automatic programme or a timed programme.

### Notes

- The laundry's care labels provide you with additional information about programme selection.  
→ *"Care symbols on the care labels", Page 22*

- Additional functions may be available as a result of software updates. → *Page 31*  
If a software update is available, you can find further information in the Home Connect app.



### 8.1 Automatic programmes

Automatic programmes are programmes in which humidity sensors measure the residual moisture in the laundry during the drying cycle. The programme only ends once the set dryness level is reached.

Each automatic programme has a dryness level → *Page 26*. The dryness level defines how dry or damp the laundry is after the programme ends.

**Tip:** Select the dryness level according to the type of fabric or the desired drying result.

Programme	Description	Max. load (kg)
Cottons	Dry hard-wearing, heat-resistant fabrics made of cotton or linen.	9.0
Eco	Dry hard-wearing, heat-resistant fabrics made of cotton or linen. Energy-saving programme.	9.0

Programme	Description	Max. load (kg)
Easy Care	Dry items made of synthetic materials or blended fabrics.	3.5
Mixed Fabrics	Dry items made of cotton and synthetics.	3.0
Bed linen	Dry duvet covers, pillowcases and sheets made of cotton. <b>Note:</b> The drum movement is optimised for drying large items of laundry.	3.5
Lingerie	Dry delicate underwear made of lace, Ly-cra, satin or blended fabrics.	2.0
Outdoor	Dry weatherproof and outdoor clothing with a membrane coating and water-repellent fabrics.	1.5
Shirts	Suitable for shirts and blouses made of cotton, linen, synthetics or blended fabrics. <b>Note:</b> For optimal drying results, dry a maximum of 5 shirts or 5 blouses at the same time. Once the laundry is dry, iron it or hang it up. The residual moisture is then distributed evenly.	1.5
Rapid 40'	Dry items made of synthetics and light cotton.	1.0
Towels	Dry hard-wearing, heat-resistant towels and dressing gowns made of cotton or linen.	6.0
smartFinish 	Reduce creasing and airborne odours. → <i>Page 27</i> To adjust the programme with crease-removal function, press the corresponding button. → <i>Page 17</i> <b>Notes</b> <ul style="list-style-type: none"> <li>▪ To prevent creasing, remove the laundry after the programme ends.</li> <li>▪ The laundry is not cleaned.</li> </ul>	-
App programs → 	Select additional programmes directly via the Home Connect app. A description of the programmes can be found in the Home Connect app.	-

Programme	Description	Max. load (kg)
	<b>Note:</b> Your appliance must be connected to your home network and registered in your Home Connect app. → <i>Page 30</i>	

## 8.2 Timed programmes

Timed programmes are programmes with a defined or adjustable programme duration. The programme ends once this time has elapsed, even if the laundry is still not dry, for example. Timed programmes are suitable for drying individual items of laundry or thin fabrics.

Programme	Description	Max. load (kg)
Wool	Dry machine-washable or hand-washable items made of wool. <b>Note:</b> Remove the items immediately once the programme has ended.	1.0
Time Progr. Warm	Dry all types of fabric except for wool and silk. Suitable for pre-dried or slightly damp laundry and for drying off multi-layered, thick laundry. <b>Note:</b> This programme is also suitable for drying using the drying basket. → <i>Page 29</i>	3.0
App programs →☰	Select additional programmes directly via the Home Connect app. A description of the programmes can be found in the Home Connect app. <b>Note:</b> Your appliance must be connected to your home network and registered in your Home Connect app. → <i>Page 30</i>	–

## 9 Accessories

Use original accessories. These have been made especially for your appliance.

**Tip:** Some accessories are available in other colours. Contact customer service. → *Page 40*

	Use	Order number
Connection kit with pull-out worktop	To save space, stack the appliance on a suitable washing machine from the same manufacturer. The pull-out worktop makes it easier to load and unload the appliance.	WZ28000
Drying basket	Dry or air sports shoes or soft toys.	WZ20610
Y-distributor	Connect the water outlet hose of an additional appliance to the same siphon outlet.	15000490
Appliance care product	Spare part for the intensive appliance care function.	00312474
Platform	Install the appliance at a raised height so that it can be easily loaded and unloaded.	WZDP30D

## 10 Laundry

### 10.1 Preparing the laundry

#### ATTENTION

Objects remaining in the laundry may damage the laundry and the drum.

- ▶ Remove all items from any pockets in your laundry before using the appliance.

#### Note



The appliance and fabrics are protected when you prepare your laundry.

- Brush off sand and soil
- Sort the laundry according to colour and textiles and observe the care labels
- Close all zips, hook and loop fasteners, hooks and eyes
- Remove curtain fittings and lead strips

- Load the laundry unfolded into the drum
- Spin the laundry before drying

### 10.2 Care symbols on the care labels

#### Drying care symbols

Symbol	Fabrics
	Items made from cotton and linen, e.g. towels, bed linen, underwear
	Items made from synthetic, blended or delicate fabrics, e.g. functional garments, shirts
	Do not tumble dry items made from silk, nylon, air-impermeable and rubber-

Symbol	Fabrics
	coated fabrics, synthetic curtains

## 11 Basic operation

### 11.1 Switching on the appliance

**Note:** If you switch the appliance on the first time after you have connected it to the electrical system, the switch-on process takes up to one minute.

**Requirement:** The appliance has been correctly installed and connected. → *Page 11*

- ▶ Press .

The switch-on process takes a few seconds.

**Note:** The lighting for the drum goes out automatically.

### 11.2 Setting a programme

1. Turn the programme selector and set the required programme.  
→ *Page 19*
- ✓ The display shows the programme settings.
2. Adjust the programme settings.  
→ *Page 17*

Observe the information about operating logic → *Page 15*.

The programme settings are not saved permanently for the programme.

### 11.3 Saving the programme settings

You can save your individual programme settings as favourites.

**Requirement:** A programme is set.  
→ *Page 23*

- ▶ Press and hold **Favourite** for approx. 3 seconds.  
Press **Favourite** to call up the saved programme.  
**Note:** To overwrite the saved programme, repeat the steps above.

### 11.4 Opening the door

1. Grip under the door handle and pull on the door.

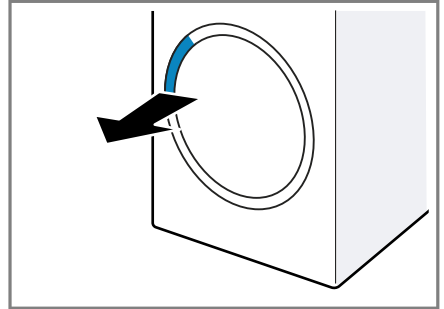

2. Open the door.

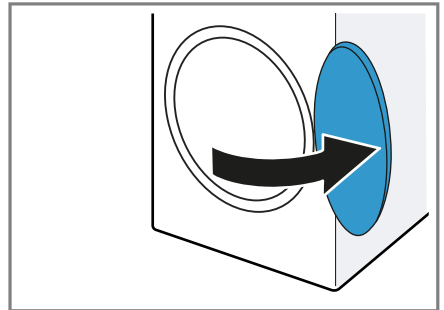

### 11.5 Loading laundry

**Note:** To prevent creasing, note the maximum load for the programmes.  
→ *Page 19*

#### Requirements

- The laundry is prepared and sorted. → *Page 22*
  - The drum is empty.
1. Open the door. → *Page 23*

## en Basic operation

2. Place the laundry in the drum.
3. Close the door.  
Ensure that there is no laundry trapped in the door.

## 11.6 Starting the programme

### Requirements

- A programme is set. → *Page 23*
- The door is closed.
- ▶ Press .
- ✓ The display shows the programme duration or the programme end time.
- ✓ After the programme has ended, the display shows: "End".

**Note:** When "Hot" is shown on the display, the appliance cools the laundry.

When "Hot" goes out, the laundry has cooled down.

## 11.7 Adding laundry

After the programme starts, you can remove or add laundry at any time.

1. Press .
- The cooling process starts automatically after approximately 30 seconds and cools down the laundry while the drum is rotating. If you want to avoid or cancel the cooling process, open the door.  
→ *Page 17*
2. Open the door. → *Page 23*
3. Add or remove laundry.
4. Close the door.
5. Start the programme. → *Page 24*

## 11.8 Cancelling the programme

1. Press .
2. Open the door. → *Page 23*
3. Remove the laundry. → *Page 24*

## 11.9 Unloading the laundry

1. Open the door. → *Page 23*
2. Remove the laundry from the drum.

## 11.10 Put the appliance into standby mode

- ▶ Press .

## 11.11 Fluff filter

During drying, fluff from the laundry is collected in the fluff filter. The fluff filter protects the appliance from fluff.

### Cleaning the fluff filter

If the drying programme has finished or the display shows a notification while the appliance is in operation, clean the fluff filter after the programme end.

**Note:** If you do not clean the appliance as described, the appliance's functionality may be impaired.

### Requirements

- The display shows the following after drying: "End"
  - or the display shows the following during operation: .
1. Open the door. → *Page 23*
  2. Remove the two-part fluff filter.

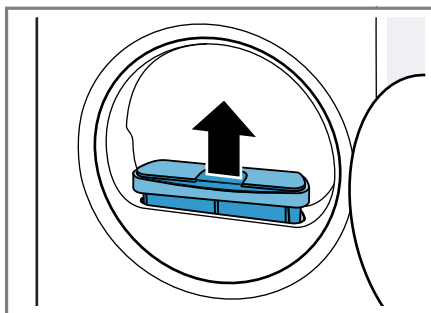



3. Remove the fluff from the recess.

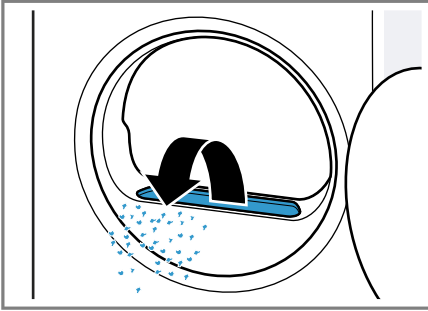

Ensure that no fluff falls into the air channel.

4. Push the centre tab of the fluff filter slightly outwards ① and separate the two-part fluff filter ②.

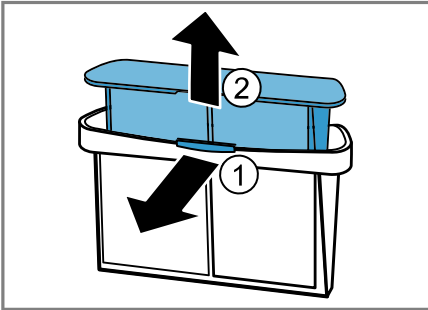

5. Open the two fluff filters ① and remove the fluff ②.

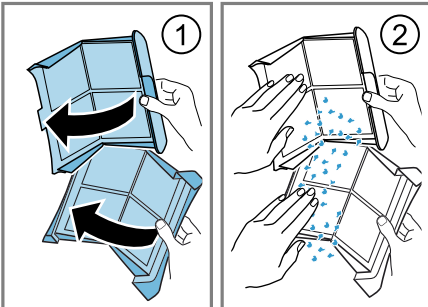

Dispose of the fluff with the household waste in order to prevent the water from being contaminated with microplastics.

6. Clean the two fluff filters thoroughly under warm, running water and then dry them off.

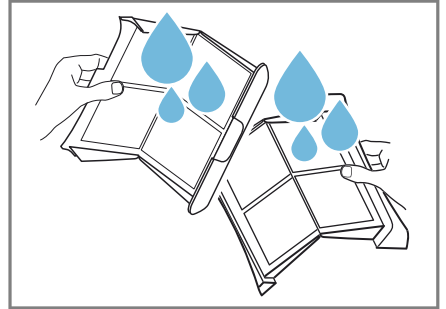

**Note:** Collect the cleaning water in a container, e.g. a bucket. After cleaning, pour the contents of the container through a filter, e.g. a coffee filter.

Dispose of the coffee filter with the household waste in order to prevent the water from being contaminated with microplastics.

7. Close the two fluff filters and put them together until the tab clicks into place.

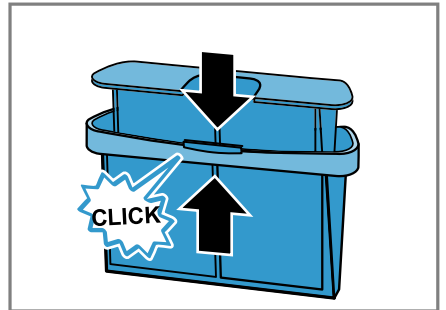

en Dryness level

8. Insert the two-part fluff filter.

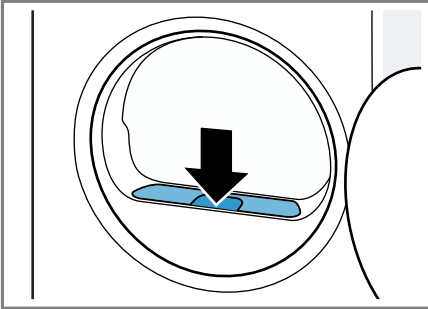

9. Close the door.

### 11.12 Condensation container

Condensation that forms in the appliance as it dries the laundry is collected by default in the condensation container.

#### Emptying the condensation container

If the drying programme has finished or the display shows a notification that the drying programme is paused, empty the condensation container.

#### Requirements

- The display shows the following after drying: "End"
- or the display shows the following while operation is paused: 

1. Pull out the condensation container, keeping it level.

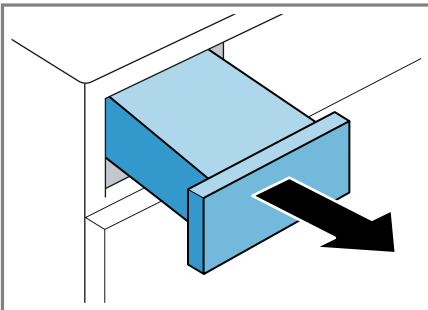

2. Empty the condensation container.

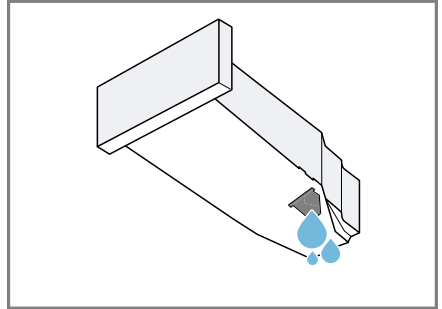

Make sure that you insert the condensation container before operating the appliance. → *Page 26*

3. If the drying programme is paused, start the programme. → *Page 24*

#### Inserting the condensation container

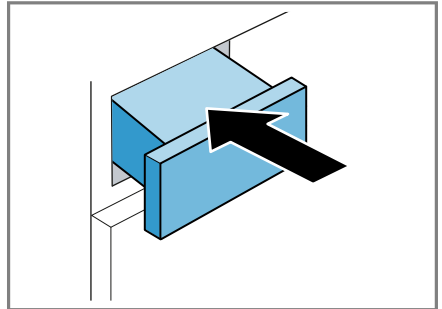

- ▶ Push the condensation container in as far as it will go.



## 12 Dryness level



Each automatic programme has a specified dryness level. The dryness level defines how dry or damp your laundry is after the programme ends.

Dryness level	Description
	For multi-layered, thick laundry that does not dry readily.

Dryness level	Description
	For normal, single-layered laundry.
	For normal, single-layered laundry. The laundry is still slightly damp after the programme ends. To prevent creasing after drying, iron the laundry or hang it up.

## 12.1 Changing the dryness level



For some automatic programmes, you can change the dryness level so that your laundry will be drier or more damp.



1. Set an automatic programme.  
→ *Page 19*
- ✓ The display shows the specified dryness level.
2. Press **Cupboard Dry** , **Cupboard Extra Dry** \* or **Iron Dry** .

## 12.2 Adjusting the dryness level

If the laundry feels too damp after it has been dried to a particular dryness level, you can adjust the dryness level.

**Note:** You can also adjust the dryness level in the basic settings.



1. Set an automatic programme.  
→ *Page 19*
- ✓ The display shows the specified dryness level.
2. Press and hold **Cupboard Dry** , **Cupboard Extra Dry** \* or **Iron Dry**  for approx. 3 seconds.
- ✓ The display shows "0", "1", "2" or "3".

3. Press  or  to adjust the dryness level from "0" (dry) to "3" (driest).
4. Press and hold the selected drying target for approx. 3 seconds to return to the automatic programme.

## 13 Childproof lock



Secure your appliance against being operated unintentionally using the controls.

### 13.1 Activating the childproof lock

- ▶ Press and hold  **3 sec.** for approx. 3 seconds.
- ✓ The display shows .
- ✓ The control elements are locked.
- ✓ The childproof lock also remains activated when the appliance is in standby mode and in the event of a power cut.

### 13.2 Deactivating the childproof lock

**Requirement:** To deactivate the childproof lock, the appliance must be switched on.

- ▶ Press and hold  **3 sec.** for approx. 3 seconds.
- ✓  goes out on the display.

## 14 Crease-removal function

In order to reduce creasing and air-borne odours, such as cigarette smoke, you can use a programme with a crease-removal function for any dry laundry that has not been worn for long or at all.

## 14.1 Starting a programme with the crease-removal function

**Note:** Wash items of laundry that have traces of sweat, perfume or deodorant before wearing them again. Do not use dryer cleaning sets. Do not use a programme with the crease-removal function for the following fabrics:

- Wool, leather and viscose
- Fabrics with parts made from metal, wood or plastic
- Waxed jackets and oilskin jackets

**Requirement:** The laundry is placed in the appliance. → *Page 23*

1. Set a programme with crease-removal function. → *Page 19*
2. If required, adjust the set programme with crease-removal function. → *Page 17*

3. Start the programme. → *Page 24*  
If the water tank is empty, the display shows:   
→ "*Filling the water tank*",  
*Page 28*

The average programme duration of the crease-removal function is approx. 45 minutes and may be longer or shorter depending on the ambient temperature.

- ✓ After the programme has ended, the display shows: "End".
4. Remove the laundry. → *Page 24*  
The results of the crease-removal function may vary depending on the type of fabric, the amount of laundry and the selected programme.  
Remove the laundry immediately after the programme has ended to prevent creasing.
  5. Hang up the items of laundry and pull them into shape.

## 14.2 Filling the water tank

Your appliance removes the creases from rarely worn clothing using cold mains water. If the display shows a notification while the appliance is in operation, fill the water tank.

### ATTENTION

Operating the appliance with water that is dirty or too hot may result in damage to the appliance.

- ▶ Only fill the water tank with cold drinking water.
- ▶ Never use condensed water, distilled water, additives or descaler for the crease-removal function.

### Requirements

- A programme with the crease-removal function has been started. → *Page 28*
  - The display shows: .
  - The condensation container → *Page 26* is removed from the appliance.
1. Add approx. 180 ml cold mains water through the front opening, using the water jug provided.

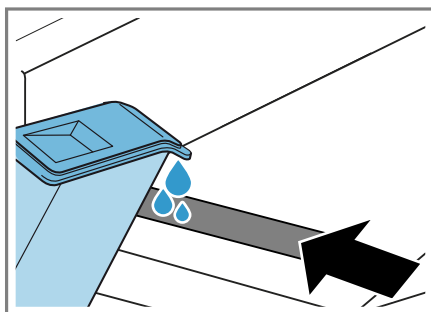

Observe the mark for filling the water tank next to the front opening. If  does not go out on the display, align the appliance correctly. → "*Aligning the appliance*",  
*Page 13*

- ✓  goes out on the display.

2. Insert the condensation container.  
→ *Page 26*
3. Start the programme. → *Page 24*

## 15 Drying basket

Use the drying basket to gently dry soft toys or sports shoes in a stationary position.

### 15.1 Inserting a drying basket

1. Open the door. → *Page 23*  
Ensure that the drum is empty.
2. Move the drying basket horizontally and with the feet last through the door opening.
3. Insert the feet of the drying basket into the holes of the door opening.

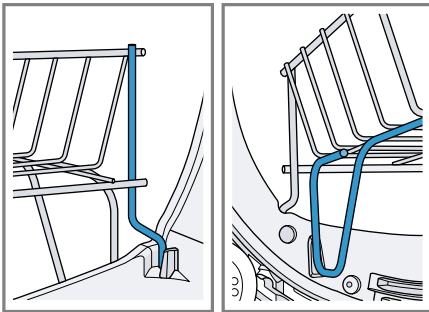

### 15.2 Starting a programme with the drying basket

**Requirement:** The drying basket has been inserted. → *Page 29*

1. Place the shoes or the soft toy in the drying basket. → *Page 29*
2. Close the door.
3. Set the **Time Progr. Warm** programme or chose a suitable programme in the Home Connect app.
4. If required, adjust the duration of the programme.
5. Start the programme. → *Page 24*
6. Remove the drying basket once the programme has ended.

### 15.3 Examples of how to use the drying basket

This information is intended to help you when using the drying basket.

#### Drying sports shoes

**Note:** Do not dry leather shoes or shoes with leather parts.

1. Lift the tongues of the shoes.
2. Remove the insoles or heel cushions.
3. Place a rolled-up hand towel in the drying basket to create an inclined surface.
4. Place the shoes on the towel with the heels facing down.

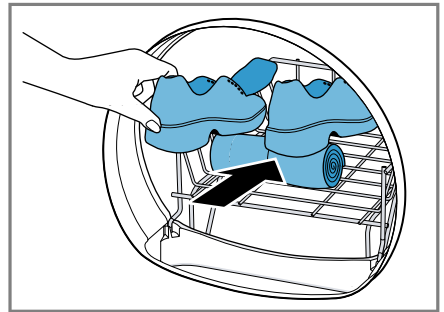

#### Drying soft toys

- ▶ Place the soft toy in the drying basket.

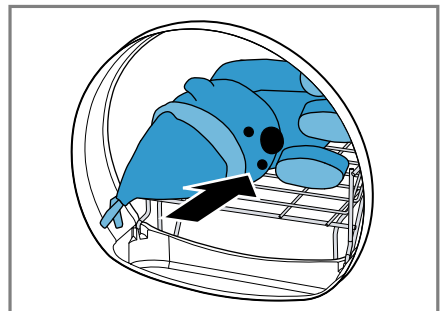

If you place numerous or small soft toys in the drying basket, make sure they do not fall out.

## 16 Home Connect

This appliance is network-capable. Connecting your appliance to a mobile device lets you control its functions via the Home Connect app, adjust its basic settings and monitor its operating status.

The Home Connect services are not available in every country. The availability of the Home Connect function depends on the availability of the Home Connect services in your country. You can find information about this at: [www.home-connect.com](http://www.home-connect.com).

The Home Connect app guides you through the entire login process. Follow the instructions, noting the information in the Home Connect app.

### Notes

- Please note the safety precautions in this instruction manual and make sure that they are also observed when operating the appliance via the Home Connect app.  
→ "Safety", Page 3
- Operating the appliance on the appliance itself always takes priority. During this time it is not possible to operate the appliance using the Home Connect app.

### 16.1 Setting up Home Connect

**Requirement:** The appliance is receiving signals from the WLAN home network (Wi-Fi) at its installation location.

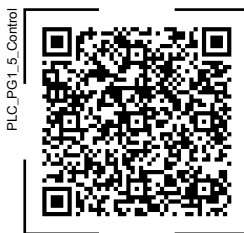

1. Scan the following QR code.



You can install the Home Connect app and connect your appliance via the QR code.



2. Follow the instructions in the Home Connect app.

### 16.2 Deactivating Wi-Fi on the appliance

1. Press and hold **Remote Start**  for approx. 3 seconds.
2. Press **Remote Start**  repeatedly until the display shows "on".
3. Press  to deactivate the Wi-Fi.  
✓ The display shows "oFF".

**Note:** To exit the Home Connect settings, press and hold **Remote Start**  for approx. 3 seconds.

### 16.3 Activating Wi-Fi on the appliance

1. Press and hold **Remote Start**  for approx. 3 seconds.
2. Press **Remote Start**  repeatedly until the display shows "oFF".
3. Press  to activate the Wi-Fi.  
✓ The display shows "on".

### Notes



- If the Wi-Fi is activated, the display alternately shows "on" and the signal strength of the Wi-Fi connection.
- To exit the Home Connect settings, press and hold **Remote Start**  for approx. 3 seconds.

## 16.4 Installing the software update

**Note:** If a software update is available, a message appears in the Home Connect app.

- ▶ To install the software update, follow the instructions in the Home Connect app.
- ✓ The control panel is partially locked during the installation.
- ✓ In the event of a malfunction, installation may take up to 40 minutes. Do not reset the network settings or the appliance to the factory settings.

## 16.5 Resetting the appliance network settings



1. Press and hold **Remote Start**  for approx. 3 seconds.
  2. Press **Remote Start**  repeatedly until the display shows "rES".
  3. Press and hold ▶ for approx. 3 seconds.
- ✓ The network settings are reset.

## 16.6 Remote start

Enable the appliance for remote start via the Home Connect app.



### Note

Remote start will be deactivated in the following circumstances:



- The appliance door is opened.
- ▶ is pressed.
- **Remote Start**  is pressed.
- Following a power cut.

## Activating remote start

### Requirements

- The appliance door is closed.
- The refresher tank is not empty.
- ▶ Press **Remote Start** .
- ✓  lights up and the appliance is enabled for remote start via the Home Connect app.

## Deactivating remote start

- ▶ Press **Remote Start** .
- ✓  goes out.

## 16.7 Intelligent programme recommendation

When you activate the intelligent programme recommendation, your appliance recommends a suitable programme for drying the laundry once you have washed your laundry in the washing machine.

### Intelligent programme recommendation

#### Requirements

- Your washing machine has the Home Connect function.
- Your washing machine and your dryer must be connected to your home network and registered in your Home Connect app.

#### 1. Press **intelligentDry**.

- ✓ The appliance detects a suitable programme. To cancel the process, set a different programme or switch the appliance to standby mode.
- ✓ If the appliance finds a suitable programme, the display for the programme lights up and the programme information is displayed.
- ✓ If the appliance does not find a suitable programme, a signal tone sounds and the display shows "- -".

#### 2. Press .

## 16.8 Remote diagnostics

Customer Service can use Remote Diagnostics to access your appliance if you contact them, have your appliance connected to the Home Connect server and if Remote Diagnostics is available in the country in which you are using the appliance.

**Tip:** For further information and details about the availability of Remote Diagnostics in your country, please visit the service/support section of your local website: [www.home-connect.com](http://www.home-connect.com).

## 16.9 Data protection

Please see the information on data protection.

The first time your appliance is registered on a home network connected to the Internet, your appliance will transmit the following types of data to the Home Connect server (initial registration):

- Unique appliance identification (consisting of appliance codes as well as the MAC address of the installed Wi-Fi communication module).
- Security certificate of the Wi-Fi communication module (to ensure a secure data connection).
- The current software and hardware version of your appliance.
- Status of any previous resetting to factory settings.

This initial registration prepares the Home Connect functions for use and is only required when you want to use the Home Connect functions for the first time.

**Note:** Please note that the Home Connect functions can only be utilised with the Home Connect app. Information on data protection can be retrieved in the Home Connect app.

## 17 Basic settings

You can configure the basic settings for your appliance to meet your needs.

**Note:** You can also adjust the basic settings in the Home Connect app.

### 17.1 Overview of the basic settings

**Note:** Additional functions may be available as a result of software updates. → *Page 31*

If a software update is available, you can find further information in the Home Connect app.

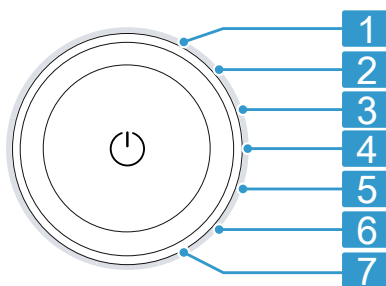

Programme selector with programme positions

- 
- |          |  |
|----------|--|
| <b>1</b> | Set the volume of the signal at the end of the programme:<br>0 (off) to 4 (very loud)                    |
| <hr/>    |  |
| <b>2</b> | Set the volume of the signal tone emitted when the buttons are pressed:<br>0 (off) to 4 (very loud)      |
| <hr/>    |  |
| <b>3</b> | Set the display brightness:<br>1 (low) to 4 (very high)  |
| <hr/>    |  |
| <b>4</b> | Adjust the dryness level<br>→ <i>Page 26</i> :<br>0 (dry) to 3 (driest)                                  |
| <hr/>    |  |
| <b>5</b> | Start the basic (CP1) or intensive (CP2) appliance care programme.<br>→ <i>"Appliance care", Page 33</i> |
-



**6** Display the number of started programmes (PC).

**7** Restore the appliance to the factory settings (rES).

## 17.2 Changing the basic settings

- To call up the basic settings, press **Basic Settings**.
- Use the programme selector to select the required basic setting.  
→ *Page 32*
- Adjust the basic setting:
  - ▶ To change the value, press  $\wedge$  or  $\vee$ .
  - ▶ To reset the appliance to the factory settings, press and hold  $\text{||} \triangleright$  for approx. 3 seconds.
- To exit the basic settings, press **Basic Settings**.

## 18 Appliance care

The appliance offers cleaning programmes for basic and intensive appliance care.

To rectify malfunctions, you can run the basic appliance care programme when the display shows "CArE".

**Note:** The basic appliance care programme runs for approximately 40 minutes.

To remove any stubborn dirt deposits in the appliance and odours after a downtime of more than one month, you can run the intensive appliance care programme.

### Notes

- The intensive appliance care programme runs for approximately 2 hours 30 minutes and must not be cancelled.
- When you run the intensive appliance care programme, you need

the original appliance care product  
→ *Page 22*.

## 18.1 Preparing for appliance care

**Requirement:** The drum is empty.

- Put the appliance into standby mode.  
→ *Page 24*
- Empty the condensation container.  
→ *Page 26*
- Switch on the appliance.
- Run the **Time Progr. Warm** programme without laundry for 30 minutes.
- Empty the condensation container.  
→ *Page 26*

## 18.2 Running the basic appliance care programme

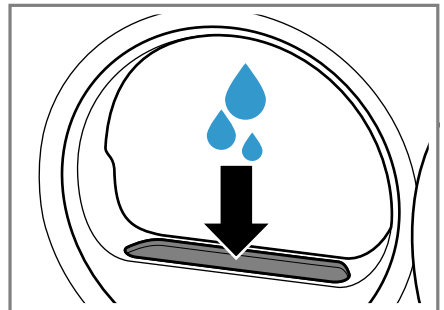

**Requirement:** The appliance care is prepared.  
→ *Page 33*

- Remove and clean the fluff filter, and put it to one side.  
→ *Page 24*
- Pour approx. 1.6 litres of mains water into the appliance through the recess of the fluff filter.



- Insert the fluff filter.
- Close the door.
- Press **Basic Settings**.
- Set the programme selector to position 5.  
→ *Page 32*
- ✓ "CP1" and the programme duration alternate on the display.
- ✓ When enough water has been filled in, a signal tone sounds.



## en Cleaning and servicing

7. Press  .
- ✓ The appliance care programme starts and a signal tone sounds.
- ✓ "End" appears on the display and a signal tone sounds once the appliance care programme has ended.
8. If you collect the condensation water in the condensation container, empty the condensation container → *Page 26*.
9. Put the appliance into standby mode. → *Page 24*

### 18.3 Running the intensive appliance care programme

#### Starting the intensive appliance care programme



**Requirement:** The appliance care is prepared. → *Page 33*

1. Remove and clean the fluff filter, and put it to one side. → *Page 24*
2. Pour a bottle of the appliance care product and approx. 1.5 litres of mains water into the appliance through the recess of the fluff filter.
3. Insert the fluff filter.
4. Close the door.
5. Press **Basic Settings** .
6. Set the programme selector to position 5. → *Page 32*
  - ✓ "CP1" and the programme duration alternate on the display.
7. Press .
- ✓ "CP2" and the programme duration alternate on the display.
- ✓ When enough water has been filled in, a signal tone sounds.
8. Press  .
- ✓ The appliance care programme starts and a signal tone sounds.
- ✓ After around 1 hour 50 minutes, the appliance pauses the appliance care programme and the re-

maintaining programme duration flashes on the display.

9. If you collect the condensation water in the condensation container, empty the condensation container → *Page 26*.

#### Continuing the intensive appliance care programme

1. Remove and clean the fluff filter, and put it to one side. → *Page 24*
2. Pour approx. 1.6 litres of mains water into the appliance through the recess of the fluff filter.
  - ✓ When enough water has been filled in, a signal tone sounds.
3. Insert the fluff filter.
4. Close the door.
5. Press  .
- ✓ The appliance care programme continues.
- ✓ "End" appears on the display and a signal tone sounds once the appliance care programme has ended.
6. If you collect the condensation water in the condensation container, empty the condensation container → *Page 26*.
7. Put the appliance into standby mode. → *Page 24*

---

## 19 Cleaning and servicing

### 19.1 Moisture sensor

The moisture sensor in this appliance measures how damp the laundry is during the drying cycle. The appliance changes the duration of the automatic programme depending on the residual moisture in the laundry.

### Cleaning the moisture sensor

Over time, residue from limescale, detergents and care products can build up on the moisture sensor. Clean the moisture sensor regularly.

#### ATTENTION

Hard or rough objects may damage the moisture sensor.

- ▶ Do not use hard or rough objects, abrasive cleaning products or steel wool for cleaning.

**Note:** If you do not clean the appliance as described, the appliance's functionality may be impaired.

1. Open the door.
2. Clean the moisture sensor with a sponge.

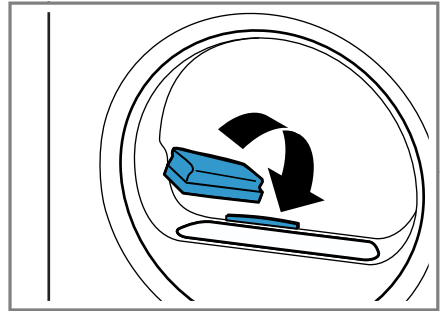

### 19.2 Door grille

The door grille on the inside of the door helps the air flow during the drying process.

#### Cleaning the door grille

Fluff can collect in the door grille after some time. This does not have any effect on energy consumption. Clean the door grille if there is any visible dirt.

- ▶ Clean the door grille with a damp cloth.

---

## 20 Troubleshooting







You can rectify minor faults on your appliance yourself. Read the troubleshooting information before contacting after-sales service. This will avoid unnecessary costs.

### ⚠ WARNING

#### Risk of electric shock!

Improper repairs are dangerous.

- ▶ Never make any technical modifications to the appliance or its features.
- ▶ Repairs to the appliance should only be carried out by trained specialist staff.
- ▶ Only use genuine spare parts when repairing the appliance.
- ▶ If the power cord of this appliance is damaged, it must be replaced by the manufacturer, the manufacturer's Customer Service or a similarly qualified person in order to prevent any risk.

Fault	Cause and troubleshooting
The display goes out and  flashes.	Energy-saving mode is active ▶ Press  .
All other error codes.	Malfunction <ol style="list-style-type: none"> <li>1. To restart the appliance, press and hold  for approximately 5 seconds.</li> <li>2. If the fault occurs again, disconnect the appliance from the power supply for at least 30 seconds. Unplug the appliance from the mains or switch off the circuit breaker in the fuse box.</li> <li>3. If the fault persists, call customer service. → <i>Page 40</i> Please specify the exact error message when calling. If possible, document the fault with photos and videos.</li> </ol>
"Hot" and the drum rotates.	Not a fault. The cooling process is active. No action required. <b>Note:</b> Do not change the programme during the cooling process. The cooling process takes up to 10 minutes.
 and programme terminated.	The condensation container is full. ▶ Empty the condensation container. → <i>Page 26</i> The water outlet hose is not connected correctly, or is kinked or trapped. ▶ Check the installation of the water outlet hose. → <i>Page 12</i> Water outlet hose is blocked. ▶ Rinse the water outlet hose with tap water.
"CArE"	The basic appliance care programme should be run. ▶ Run the basic appliance care programme → <i>Page 33</i> .
	Fluff filter is soiled. ▶ Clean the fluff filter. → <i>Page 24</i>
	The water tank for the crease-removal function is empty. ▶ Fill the water tank. → <i>Page 28</i>
The display and buttons do not respond.	Software fault. <ol style="list-style-type: none"> <li>1. To restart the appliance, press and hold  for approximately 5 seconds.</li> <li>2. If the fault occurs again, disconnect the appliance from the power supply for at least 30 seconds. Unplug the appliance from the mains or switch off the circuit breaker in the fuse box.</li> </ol>

Fault	Cause and troubleshooting
Home Connect is not working properly.	Different causes are possible. <ol style="list-style-type: none"> <li>1. Reset the appliance network settings. → <i>Page 31</i></li> <li>2. Set up Home Connect again. → <i>Page 30</i></li> </ol> ▶ Go to <a href="http://www.home-connect.com">www.home-connect.com</a> .
Water overflows when filling the water tank.	The water tank is completely full. No action required. <p><b>Note:</b> The overflowing water is harmless. Do not pour any more water into the water tank.</p>
	The water tank filter is soiled. ▶ Clean the water tank filter.
The programme does not start.	Childproof lock is activated. ▶ Deactivate the childproof lock. → <i>Page 27</i>
	<b>Ready In</b> is activated. ▶ Check whether <b>Ready In</b> is activated. → <i>Page 19</i>
The length of the programme changes during the drying cycle.	Not a fault. The programme sequence is optimised electronically. No action required.
The drying time is too long.	Fluff filter is soiled. ▶ Clean the fluff filter. → <i>Page 24</i>
	The ambient temperature is lower than 15 °C or higher than 30 °C. ▶ Ensure that the ambient temperature is between 15 °C and 30 °C.
	The air circulation at the appliance's installation location is insufficient. ▶ Ventilate the appliance's installation location.
	Insufficient condensation for the automatic self-cleaning function when permanently drying small loads of laundry or when permanently using the crease-removal function. ▶ Regularly dry a load weighing more than 3 kg of damp laundry until the programme ends.
	The appliance's ventilation opening is blocked. ▶ Ensure that the ventilation opening of the appliance is kept clear.
	Heat exchanger is soiled. ▶ Run the basic appliance care programme → <i>Page 33</i> .
Drum movement direction changes during drying.	Not a fault. The laundry is better distributed for optimum drying results. No action required.

<b>Fault</b>	<b>Cause and troubleshooting</b>
The crease-removal function takes too long.	A low ambient temperature extends the duration of the crease-removal function. No action required.
Humming, whirring or pumping noises.	Not a fault. The compressor, compressor ventilation or condensation pump is active. No action required.
The laundry is too damp.	The selected programme is unsuitable for the type of fabric. ▶ Set a time programme for subsequent drying. → <i>Page 21</i>
	The load is too large. ▶ Observe the programme's maximum load capacity. → <i>Page 19</i>
	After the end of the programme, warm laundry feels damper than it actually is. <b>1.</b> Remove the laundry from the drum as soon as the drying programme has finished. <b>2.</b> Spread the items of laundry for cooling.
	The selected dryness level is unsuitable. ▶ Change the dryness level. → <i>Page 27</i>
	The dryness level is not adjusted. ▶ Adjust the dryness level. → <i>Page 27</i>
Creasing.	The load is too small. ▶ Set a time programme for subsequent drying. → <i>Page 21</i>
	The moisture sensor is dirty. ▶ Clean the moisture sensor. → <i>Page 35</i>
	The appliance has interrupted the drying process due to the condensation container being full. ▶ Empty the condensation container. → <i>Page 26</i>
	The selected programme is unsuitable for the type of fabric. ▶ Set a suitable programme. → <i>Page 19</i>
	The load is unsuitable. ▶ Observe the programme's maximum load capacity. → <i>Page 19</i> ▶ Prepare the laundry. → <i>Page 22</i>
	The laundry lies in the drum for too long after drying. <b>1.</b> Remove the laundry from the drum as soon as the drying programme has finished. <b>2.</b> Spread the items of laundry for cooling.

<b>Fault</b>	<b>Cause and troubleshooting</b>
Creasing.	Easy Care fabrics have been dried for too long. ▶ Change or adjust the dryness level. → <i>Page 26</i>
	The crease-reduction function is not activated. ▶ Activate the crease-reduction function. → <i>Page 17</i>
Water is leaking from the appliance.	Appliance is not correctly aligned. ▶ Align the appliance. → <i>Page 13</i>
	Water outlet hose is not connected correctly. ▶ Check the installation of the water outlet hose. → <i>Page 12</i>
Odours have formed in the appliance.	Stubborn dirt in the appliance or an extended appliance downtime of more than one month. ▶ Run the intensive appliance care programme. → <i>Page 33</i>

## 21 Transportation, storage and disposal

### 21.1 Emptying the base unit

Remove residual water from the base unit before transporting.

1. Empty the condensation container.  
→ *Page 26*
2. Run the **Time Progr. Warm** programme without laundry for 30 minutes.
3. Empty the condensation container.  
→ *Page 26*

### 21.2 Disposing of old appliance

Valuable raw materials can be re-used by recycling.

#### **WARNING**

##### **Risk of harm to health!**

Children can lock themselves in the appliance, thereby putting their lives at risk.

- ▶ Do not install the appliance behind a door as this may obstruct the appliance door or prevent it from opening.

- ▶ With redundant appliances, unplug the power cord. Then cut through the cord and damage the lock on the appliance door beyond repair so that the appliance door will no longer close.

#### **WARNING**

##### **Risk of fire!**

The refrigerant R290 used in this appliance is environmentally friendly. It is however flammable and may ignite if appliances are not disposed of properly.

- ▶ Dispose of the appliance properly.
- ▶ Do not damage the tubing of the refrigerant circuit.

1. Unplug the appliance from the mains.
2. Cut through the power cord.
3. Dispose of the appliance in an environmentally friendly manner. Information about current disposal methods are available from your specialist dealer or local authority.



This appliance is labelled in accordance with European Directive

2012/19/EU concerning used electrical and electronic appliances (waste electrical and electronic equipment - WEEE). The guideline determines the framework for the return and recycling of used appliances as applicable throughout the EU.

---

## 22 Customer Service

Function-relevant genuine spare parts according to the corresponding Eco-design Order can be obtained from Customer Service for a period of at least 10 years from the date on which your appliance was placed on the market within the European Economic Area.

**Note:** Under the terms of the manufacturer's warranty the use of Customer Service is free of charge.

Detailed information about the warranty period and the warranty conditions in your country is available via the QR code on the enclosed document on service contacts and war-

ranty conditions, from our customer service or on our website.

If you contact Customer Service, you will require the product number (E-Nr.), the production number (FD) and the consecutive numbering (Z-Nr.) of your appliance.

You can find the contact details for our customer service via the QR code on the enclosed document on service contacts and warranty conditions or on our website.

### 22.1 Product number (E-Nr.), production number (FD) and consecutive numbering (Z-Nr.)

You can find the product number (E-Nr.), the production number (FD) and the consecutive numbering (Z-Nr.) on the appliance's rating plate.

Depending on the model, the rating plate is located:

- On the inside of the door.
- On the inside of the maintenance flap.
- On the rear of the appliance.

Make a note of your appliance's details and the Customer Service telephone number to find them again quickly.

---

## 23 Consumption values

The **Eco** programme is suitable for drying cotton laundry with a normal dampness level, and is the most efficient programme for drying damp cotton laundry in terms of combined energy consumption. This programme serves to assess compliance with Regulations (EU) 2023/2533 and (EU) 2023/2534. The consumption values for this programme that are declared on the energy label refer to a moisture content of the laundry of 60%.













The values specified for other programmes are indicative only and were determined in accordance with the applicable standard EN61121.

The actual values may deviate from the indicated values depending on the type of fabric, composition of laundry to be dried, residual moisture in the fabric, set















degree of dryness, amount of laundry being loaded, environmental conditions and the activation of additional functions.

The expected programme duration/"Ready in" time that is shown on the appliance display when selecting the programme is based on the spin speed in the washing machine of 1000 rpm when the appliance is delivered.

<b>Programme</b>	<b>Final moisture level (%)</b>	<b>Load (kg)</b>	<b>Spin speed (rpm)</b>	<b>Initial moisture level (%)</b>	<b>Programme duration (h:min)</b>	<b>Energy consumption (kWh/cycle)</b>
Cottons + Cupboard Extra Dry 	-3.0	9.0	1400	50	4:55	1.30
Cottons + Cupboard Extra Dry 	-3.0	4.5	1400	50	2:49	0.68
Cottons + Cupboard Extra Dry 	-3.0	9.0	1000	60	5:18	1.46
Cottons + Cupboard Extra Dry 	-3.0	4.5	1000	60	3:01	0.76
Cottons + Cupboard Extra Dry 	-3.0	9.0	800	70	5:42	1.63
Cottons + Cupboard Extra Dry 	-3.0	4.5	800	70	3:14	0.84
Cottons + Cupboard Dry 	-1.5	9.0	1400	50	4:28	1.18
Cottons + Cupboard Dry 	-1.5	4.5	1400	50	2:45	0.63
Cottons + Cupboard Dry 	-1.5	9.0	1000	60	4:51	1.34
Cottons + Cupboard Dry 	-1.5	4.5	1000	60	2:57	0.71
Cottons + Cupboard Dry 	-1.5	9.0	800	70	5:14	1.50
Cottons + Cupboard Dry 	-1.5	4.5	800	70	3:09	0.79
Eco	0.0	9.0	1400	50	3:58	1.08
Eco	0.0	4.5	1400	50	3:09	0.56
Eco <sup>1</sup>	0.0	9.0	1000	60	4:25	1.25

<sup>1</sup> The acoustical noise emissions during the drying cycle are 57 dB.

Programme	Final moisture level (%)	Load (kg)	Spin speed (rpm)	Initial moisture level (%)	Programme duration (h:min)	Energy consumption (kWh/cycle)
Eco	0.0	4.5	1000	60	3:15	0.65
Eco	0.0	9.0	800	70	4:52	1.43
Eco	0.0	4.5	800	70	3:22	0.74
Cottons + Iron Dry 	12.0	9.0	1400	50	2:50	0.72
Cottons + Iron Dry 	12.0	4.5	1400	50	1:49	0.41
Cottons + Iron Dry 	12.0	9.0	1000	60	3:13	0.88
Cottons + Iron Dry 	12.0	4.5	1000	60	2:02	0.49
Cottons + Iron Dry 	12.0	9.0	800	70	3:37	1.05
Cottons + Iron Dry 	12.0	4.5	800	70	2:14	0.57
Easy Care + Cupboard Extra Dry 	0.0	3.5	800	40	1:37	0.37
Easy Care + Cupboard Extra Dry 	0.0	3.5	600	50	1:53	0.44
Easy Care + Cupboard Dry 	2.0	3.5	800	40	1:21	0.30
Easy Care + Cupboard Dry 	2.0	3.5	600	50	1:37	0.38
Easy Care + Iron Dry 	12.0	3.5	800	40	1:05	0.22
Easy Care + Iron Dry 	12.0	3.5	600	50	1:21	0.29
Lingerie	0.0	2.0	-	-	1:26	0.33

## 24 Technical data

Appliance height 84.2 cm

Appliance width 59.8 cm

Appliance depth 62.7 cm

Appliance depth with door closed 67.5 cm

Appliance depth with door open 111.9 cm

Weight 56.0 kg

Maximum load	9.0 kg
Mains voltage	220-240 V, 50 Hz
⇌ Minimum installation protection	10 A
Nominal power	850 W
Power consumption	<ul style="list-style-type: none"> <li>■ Standby mode: 0.30 W</li> </ul>
Ambient temperature	<ul style="list-style-type: none"> <li>■ Minimum: 5 °C</li> <li>■ Maximum: 35 °C</li> </ul>
Length of the power cord	180 cm

This product contains light sources from energy efficiency class F. These light sources are available as a spare part and must only be replaced by trained specialist staff.

More information about your model can be found online at <https://eprel.ec.europa.eu/qr/2274428><sup>1</sup>.

This web address is linked to the official EU EPREL product database.

## 24.1 Information regarding Free and Open Source Software

This product includes software components that are licensed by the copyright holders as free or open source software.

The applicable licence information is stored on your home appliance. You can also access the applicable licence information via your Home Connect app: "Profile -> Legal information -> Licence Information".<sup>2</sup> You can download the licence information on the brand product web-

site. (Please search on the product website for your appliance model and additional documents). Alternatively, you can request the relevant information from [oss-request@bshg.com](mailto:oss-request@bshg.com) or BSH Hausgeräte GmbH, Carl-Wery-Str. 34, 81739 Munich, Germany.

The source code will be made available to you on request.

Please send your request to [oss-request@bshg.com](mailto:oss-request@bshg.com) or BSH Hausgeräte GmbH, Carl-Wery-Str.34, 81739 Munich, Germany.

Subject: „OSSREQUEST“

The cost of performing your request will be charged to you. This offer is valid for three years from the date of purchase or at least as long as we offer support and spare parts for the relevant appliance.

<sup>1</sup> Only applies to countries in the European Economic Area. This website address is available from 1st July 2025.

<sup>2</sup> Depending on the appliance specifications

## 25 Declaration of Conformity

BSH Hausgeräte GmbH hereby declares that the appliance with Home Connect functionality conforms to the essential requirements and other relevant provisions of Directive 2014/53/EU.

A detailed RED Declaration of Conformity can be found online at [siemens-home.bsh-group.com](http://siemens-home.bsh-group.com) among the additional documents on the product page for your appliance.



Hereby, BSH Hausgeräte GmbH declares that the appliance with Home Connect functionality is in compliance with relevant statutory requirements.<sup>1</sup>

A detailed Declaration of Conformity can be found online at [siemens-home.bsh-group.com/uk/](http://siemens-home.bsh-group.com/uk/) among the additional documents on the product page for your appliance.<sup>1</sup>



2.4 GHz band (2400–2483.5 MHz): Max. 100 mW

5-GHz band (5150–5350 MHz + 5470–5725 MHz): max. 150 mW

	BE	BG	CZ	DK	DE	EE	IE	EL	ES
	FR	HR	IT	CY	LI	LV	LT	LU	HU
	MT	NL	AT	PL	PT	RO	SI	SK	FI
	SE	NO	CH	TR	IS	UK (NI)			

5 GHz WLAN (Wi-Fi): For indoor use only.

AL	BA	MD	ME	MK	RS	UK	UA
----	----	----	----	----	----	----	----

5 GHz WLAN (Wi-Fi): For indoor use only.

### 25.1 Statement of Compliance for Great Britain

The full Statement of Compliance according to the Product Security and Telecommunications Infrastructure (Security Requirements for Relevant Connectable Products) Regulations 2023 can be found online at [www.siemens-home.bsh-group.com/uk/home](http://www.siemens-home.bsh-group.com/uk/home) among the additional documents on the product page for your appliance.

### Product type

This statement of compliance covers the products described in this information for use whose model identifier group is seen on the title page. The full model identifier is made up of the characters before the slash in the product number (E no.) which can be found on the rating plate. Alternatively, you can also find the model identifier in the first line of the UK Energy Label.

<sup>1</sup> Only applies to Great Britain

**Name and address of manufacturer**

BSH Hausgeräte GmbH, Carl-Wery-Strasse 34, 81739 München, Germany

This statement of compliance is prepared by the manufacturer.

The manufacturer, BSH Hausgeräte GmbH deems that it has complied with

- provision 5.1-1 of ETSI EN 303 645 v2.1.1 and, where relevant, provision 5.1-2 of ETSI EN 303 645 v2.1.1;
- provision 5.2-1 of ETSI EN 303 645 v2.1.1;
- provision 5.3-13 of ETSI EN 303 645 v2.1.1.

**Support period**

BSH Hausgeräte GmbH will provide security updates that are necessary to maintain the main functions free of charge until at least 28/02/2034.



A series of horizontal lines spanning the width of the page, providing a template for writing. The lines are evenly spaced and extend across the entire width of the page, starting from the top line and continuing down to the bottom line.



EN Manufactured by BSH Hausgeräte GmbH under the trademark licence of Siemens AG

Valid within Great Britain:  
Imported to Great Britain by  
BSH Home Appliances Ltd.  
Grand Union House  
Old Wolverton Road  
Wolverton, Milton Keynes  
MK12 5PT  
United Kingdom

**BSH Hausgeräte GmbH**  
Carl-Wery-Straße 34  
81739 München, GERMANY  
[siemens-home.bsh-group.com](http://siemens-home.bsh-group.com)



**9002023896** (050902)  
en