

AquaFloe Iris 8mm Sliding Shower Door

Instruction Manual

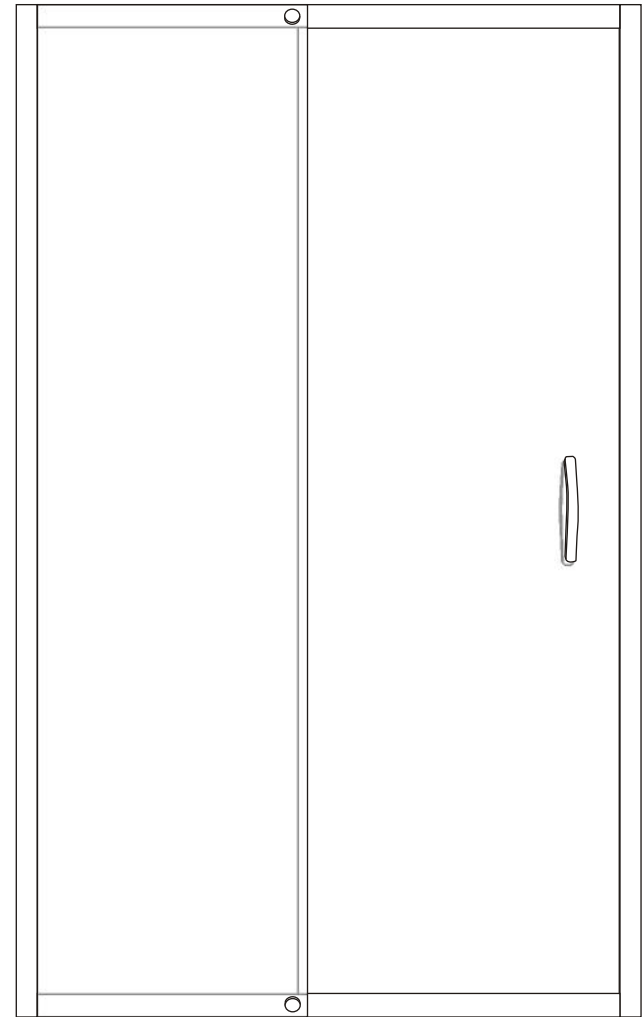





Important Reminder

1. Please install the shower enclosure according to the instruction , otherwise, it will affect the operational performance.
2. After opening the carton, please check the parts according to the part list.
3. Please handle the glass parts carefully to avoid impact
4. If installing on a tray, follow correct method of installation by installing the tray and tile down onto this.
5. After installation , do not use for 24hours.



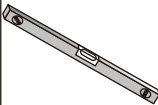

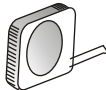

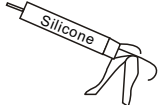
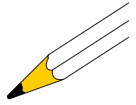



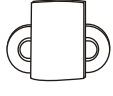
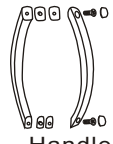

Notice

1. Do not climb or hang heavy things on the shower enclosure.
2. Do not knock and impact the glass.
3. Caution slippery on the inside of the shower enclosure.
4. Ordinary liquid detergent should be used with a soft cloth for cleaning.
5. Apply silicone to prevent water leakage.
6. Keep the tray clean, remove hair and debris to prevent blockages

Tools:

			
Spirit Level	Drill	Tape measure	Cross screw driver
			
Scissors	Silicone Gun	Pencil	

Part list

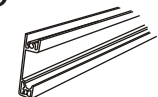
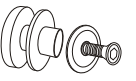
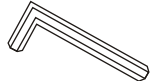
A  Screws ST4X25 X8	B  ST4X20 Small round head screw X8	C  Screws ST4X10 X8	D  Wall plug X8
E  Bottom spring roller X2	F  Top roller X2	G  Handle X1	H  Drill bit 3mm X1
I  Rubber Seal X2	J  Magnetic Seal X1	K  Wall Profile X2	L  Door profile X1
M  Fixed Glass Panels X1	N  Sliding Door X1	O  Top&bottom rail X2	P  Glass fixture sets X2
Q  Allen Key X1			

Part O -Top & Bottom rail length

- 1100 Enclosure - 977mm
- 1200 Enclosure - 1077mm
- 1400 Enclosure - 1277mm
- 1500 Enclosure - 1377mm
- 1600 Enclosure - 1477mm
- 1700 Enclosure - 1577mm

STEP1: Wall profiles assembling

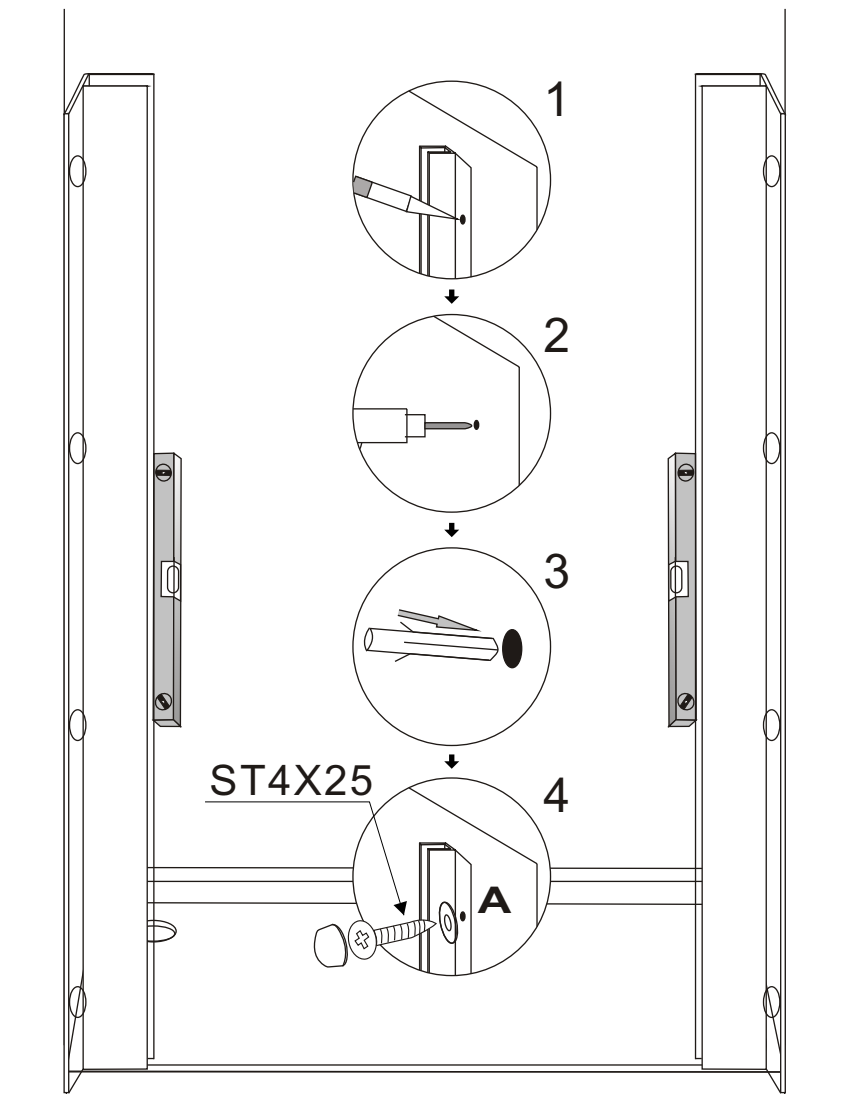

Place the wall channels against the wall and using a spirit level ensure these are vertical.

Mark the drill holes through the wall channel.

Drill holes by a suitable drill bit and screw the wall channel on the sliding door side to the wall first. Put the screw caps on accordingly.

STEP2:

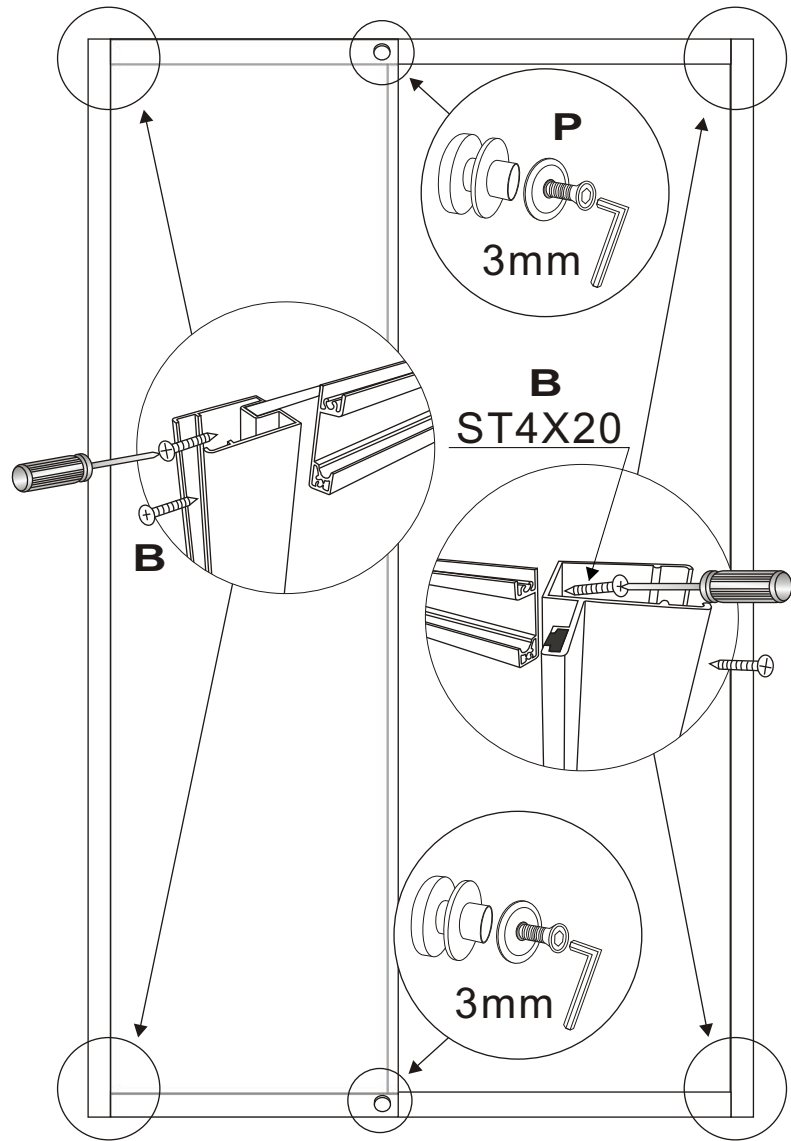

-Connect the top and bottom rail to the upright profile with fixed glass as well as the door profile.
Screw the fixed glass to the top and bottom rail by glass fixture.

STEP3:

Fixed glass panels Assembling

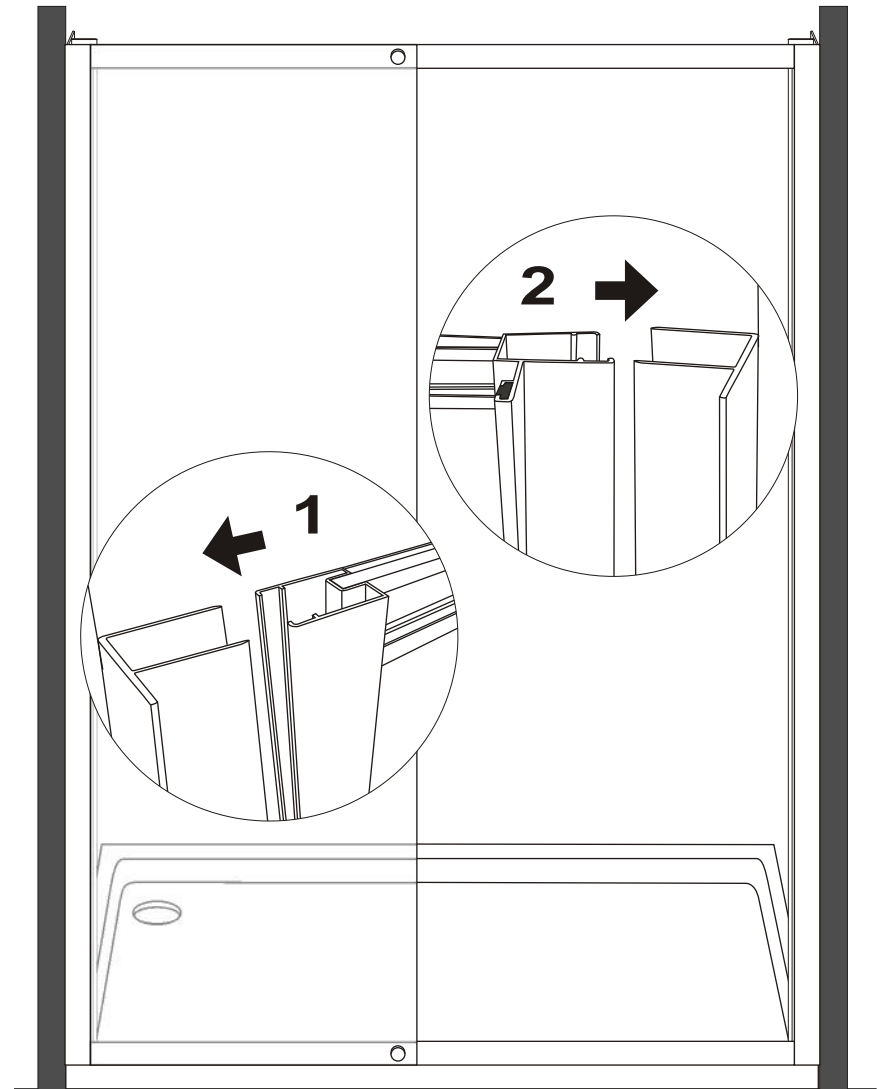

-Insert the whole frame into the wall profile on the fixed glass side first. Then insert the whole frame into the wall profile screwed on the wall on the sliding door side.

STEP4:

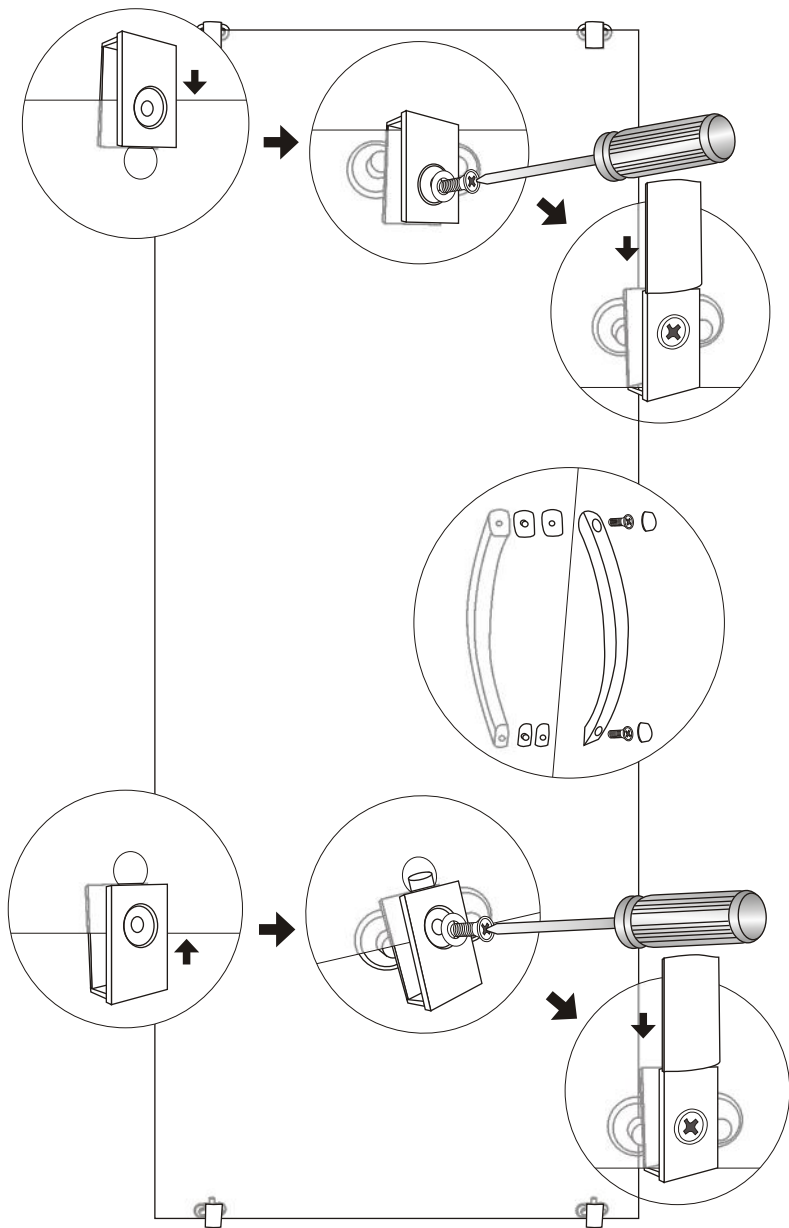

STEP5:

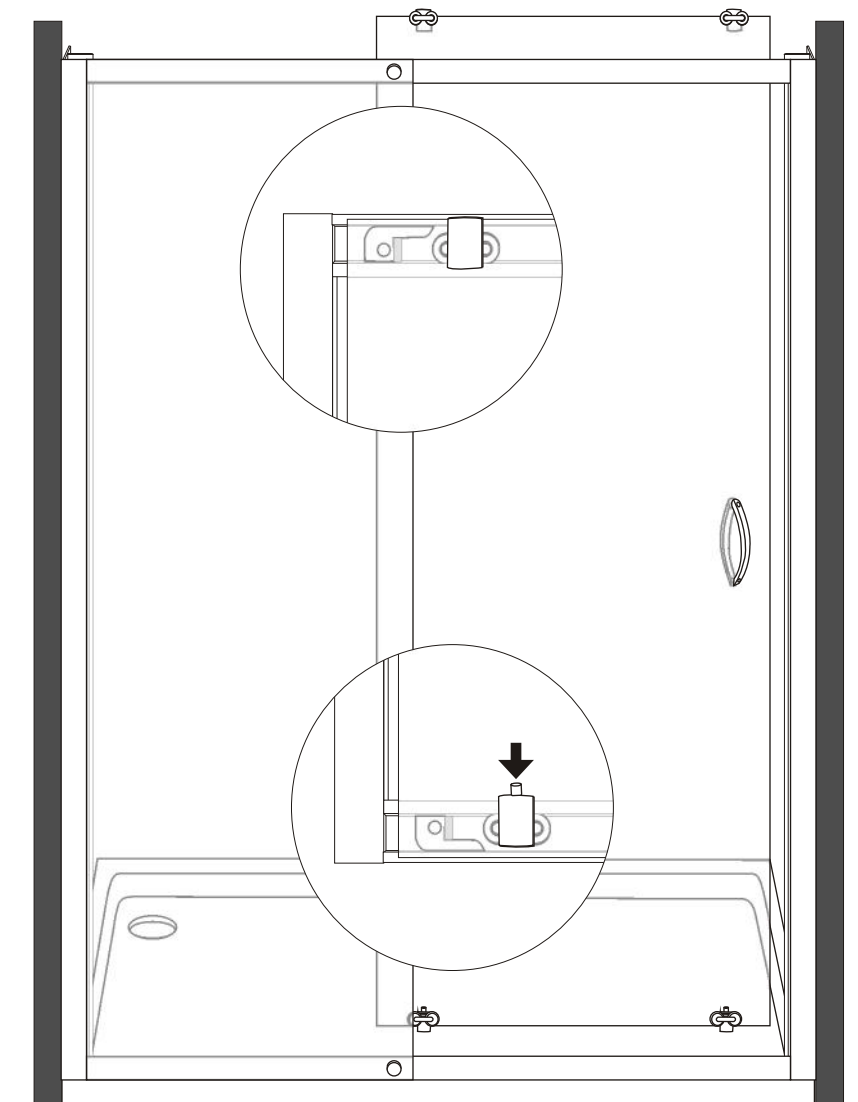

-Push the button and push the bottom spring roller into the bottom rail.

STEP6:

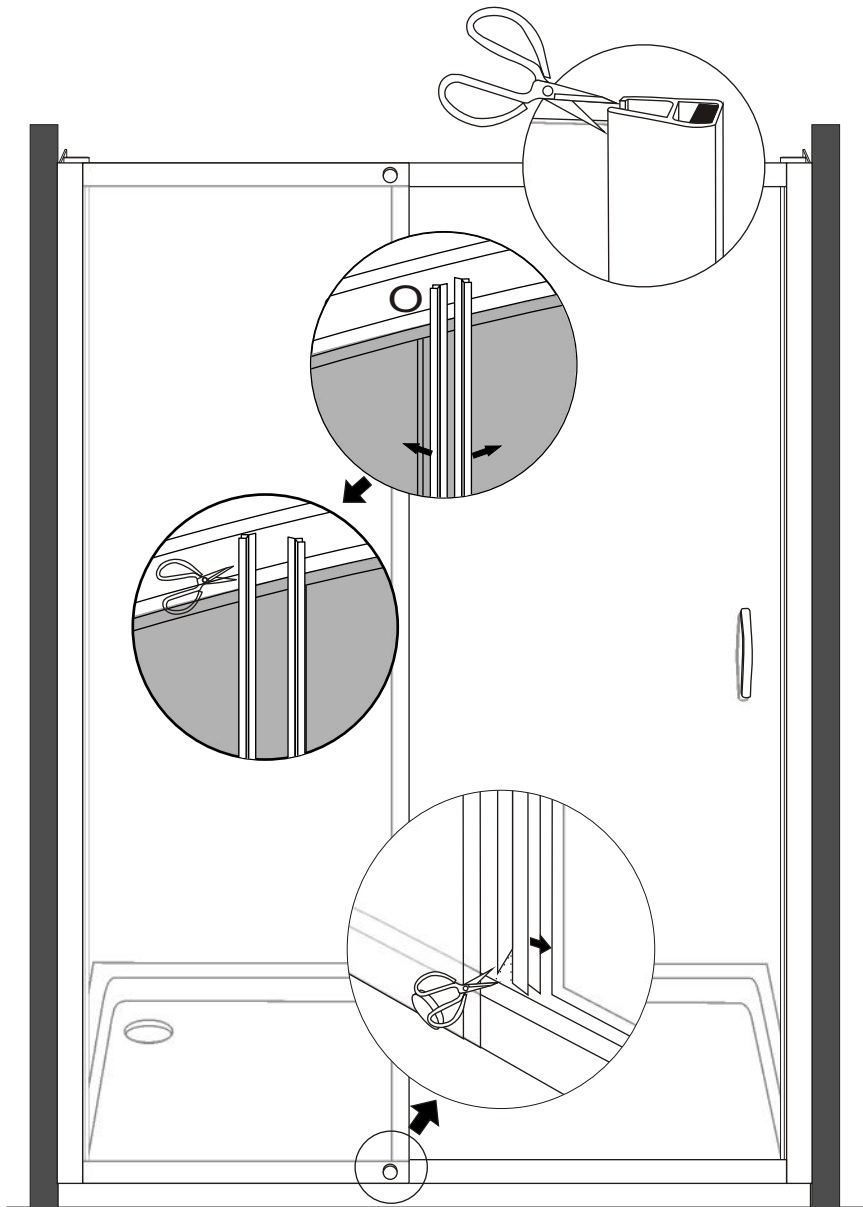

STEP7:

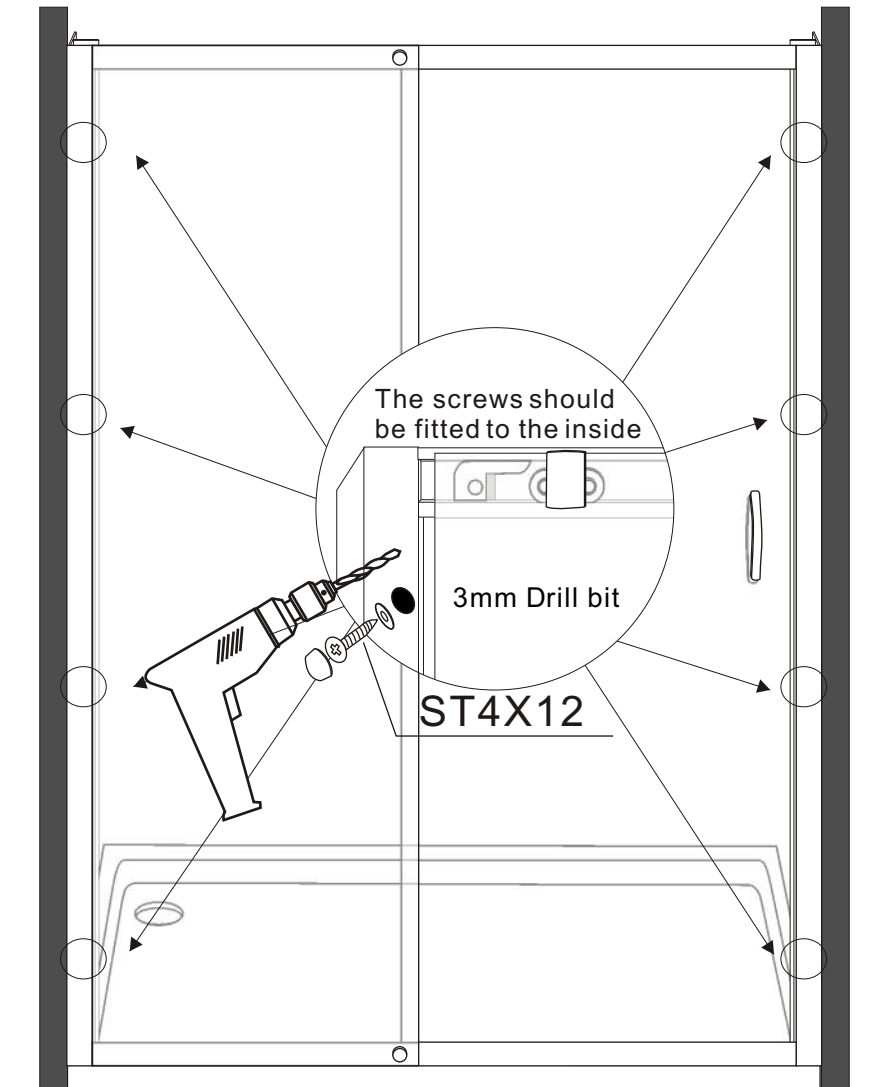

- The holes are not pre-drilled on the wall profile.
- Drill holes on each side, using 3mm drill bit.
- Then screw the wall profile to the fixed glass profile and door profile.

Silicone Application

STEP8(1):

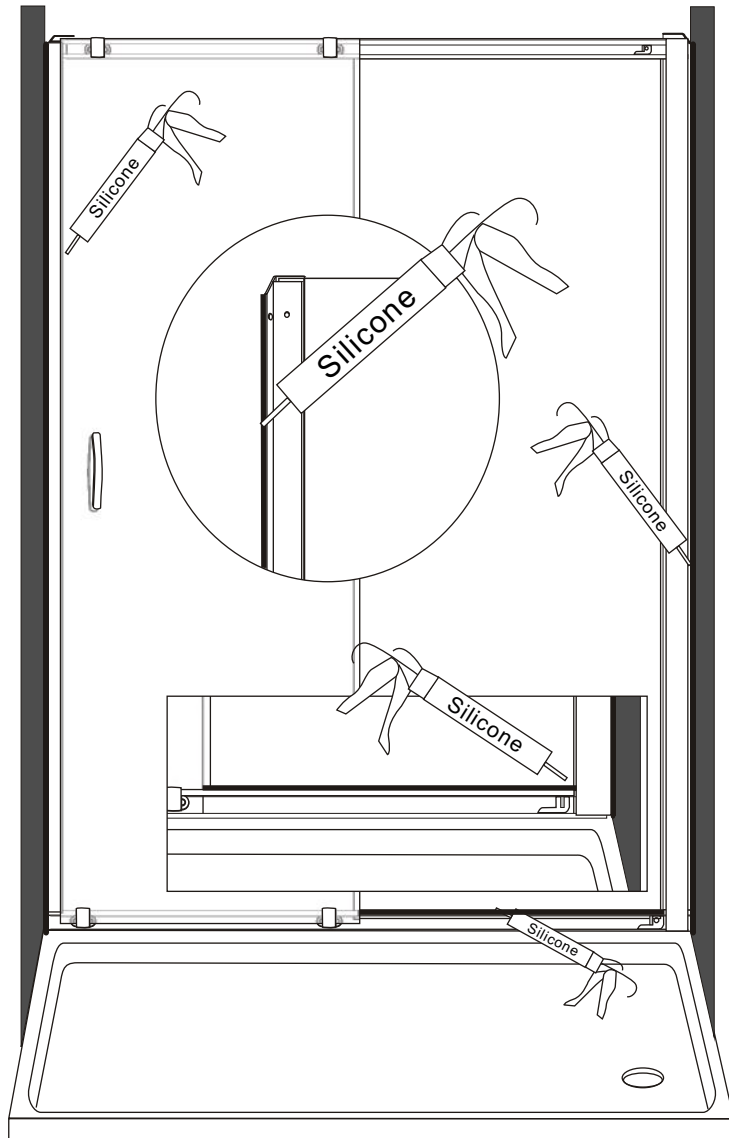

-Apply silicone sealant to all joints between wall profile, fixed glass panel, bottom aluminium alloy rail.

STEP8(2):

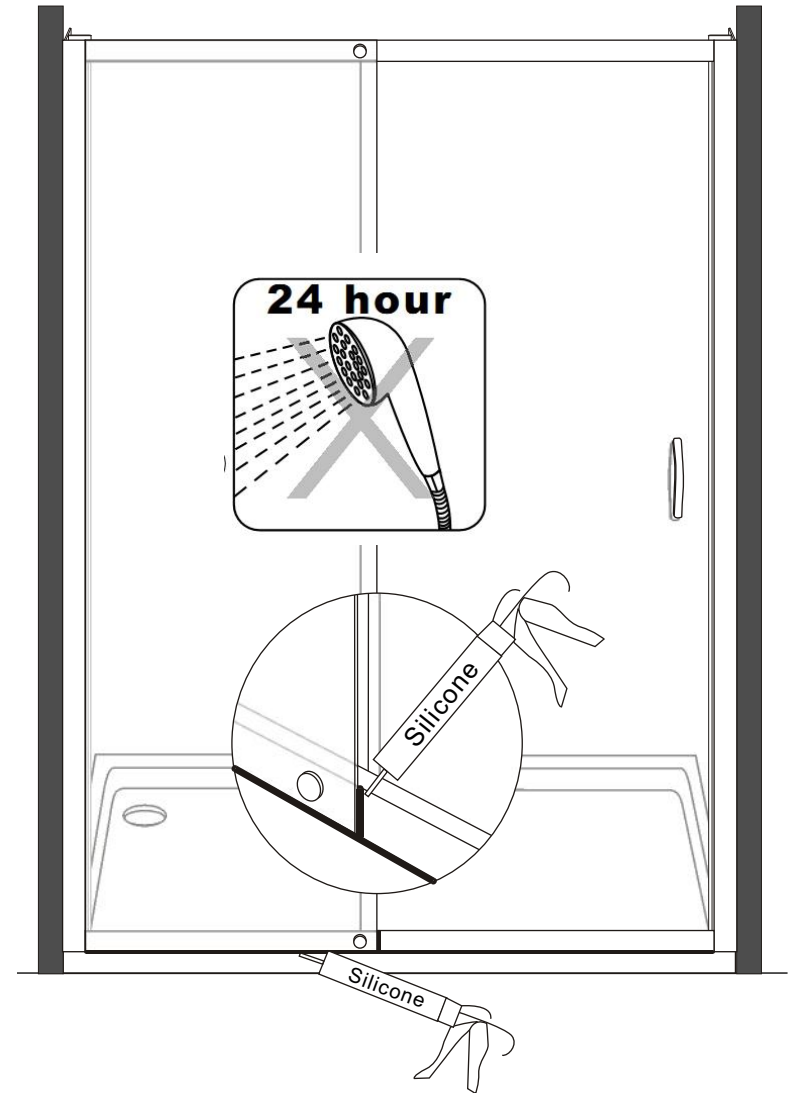

-Apply silicone sealant to all joints between fixed glass panel, bottom aluminium alloy rail and tray.
-Do not use the enclosure for 24 hours, to allow the silicone to dry completely.