

Bath Installation Instructions

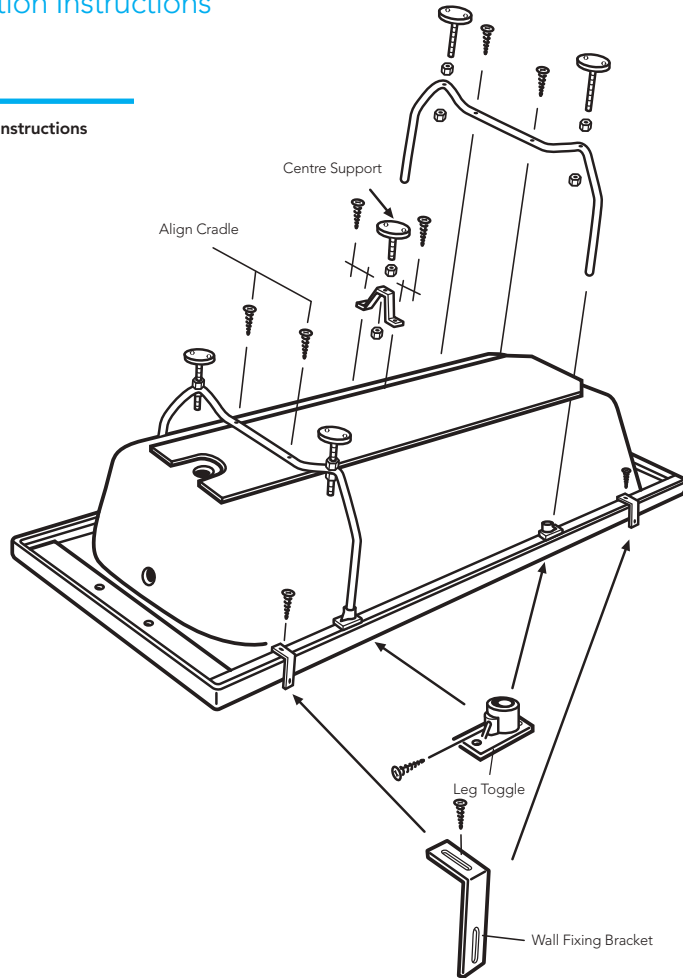

Bath fitting instructions



1. Remove all packaging including the polyethylene film, which covers the entire bath.
2. Check that colour match is acceptable and that there is no damage on the bath that may have occurred during transit. This can only be done if the film is removed completely.
3. Remove the two tubular cradle legs from the bath frame (keep the screws for instruction 5).
4. If required using the 23mm fixing screws attach the black housing socket to the bath frame.
5. Align the cradle and hand screw directly into the baseboard using the 32mm (1 ¼") screws from instructions 3. **YOU MUST CHECK THE SCREW LENGTH** – Should the bath have an 'H' frame fitted to the baseboard align and secure cradle to it. If the cradle stands proud of the baseboard it can be shortened using a hacksaw.
6. Once the cradles have been secured to the baseboard of the bath secure them into the legs toggles with the self tapping screw provided making sure the self tapping screw pierces the steel leg. This will be easier if pre-drilled with a 3.2mm bit.
7. Secure the adjustable M10 feet to the cradles using M10 nuts provided.
8. Secure the adjustable centre support using screw and nuts provided to the centre of the baseboard (or 'H' frame).
9. With the bath in the upright position set top face level using threaded adjustment of feet and lock-nuts. When a panel is to be fitted set bath height to height of panel.
10. **CHECK THAT THE BATH RIM IS LEVEL.**
11. Before the final fixing of the bath, fit tap and waste fittings using a suitable sealing compound. When complete place bath into position, re-check levels and make any final adjustments necessary. Finally secure the feet to the floor and the wall brackets to the wall. Movement may occur if not fitted correctly.

Quality Acrylic Baths
Manufactured in the UK

Bath Installation Instructions

- Prior to fitting your bath, carefully remove all the packaging and film from the bath and examine the bath for damage and suitability of colour match.
- Check the panel fit and match prior to installation.
- Note instruction 10 before final fixing.
- Any refixing costs or claims for wrong colour match, and/or any other faults will not be accepted after fixing.

No claims for the above will be accepted once the bath is fitted

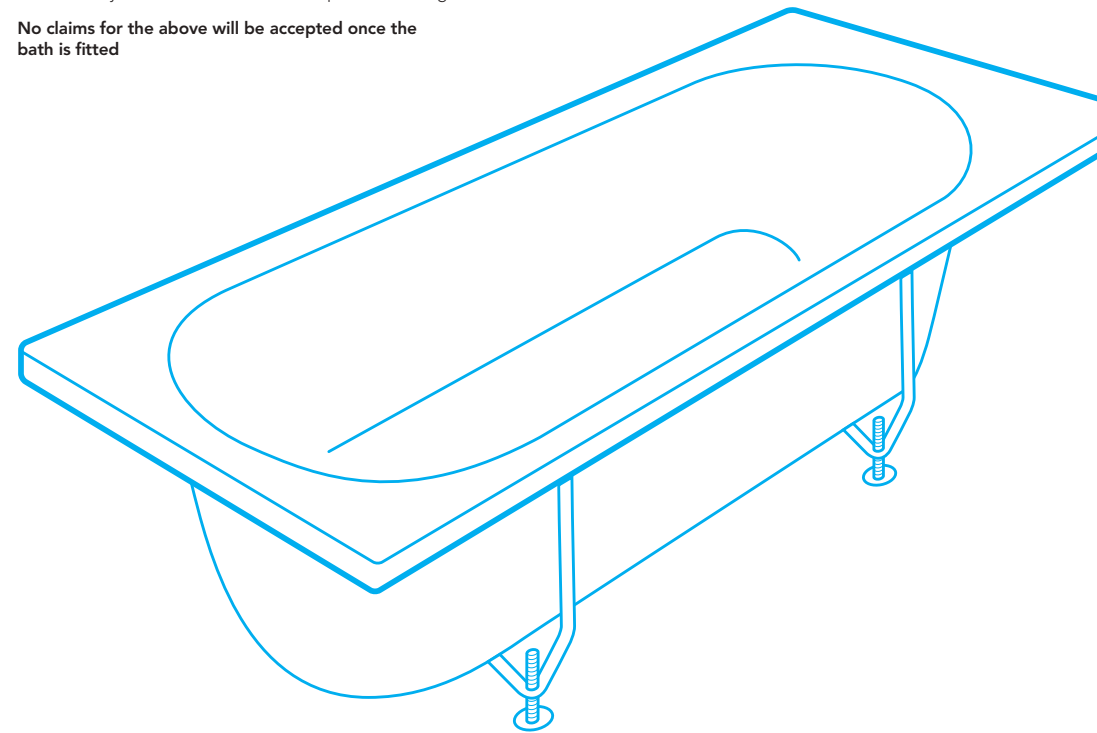

25
Year
Guarantee

Bath

Installation Instructions

Before you start

- Before fixing remove ALL protective covering and examine carefully. The polythene film must be removed in full and the bath checked for any visible damage.
- Unpack and check the product is complete and undamaged.
- Have the correct tools available.

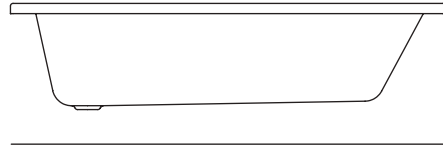







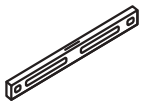

Safety

- Handle bath with care.
- This Product is heavy and requires two people to carry.
- When drilling walls, check first for hidden pipes and cables.
- Use safety eyewear when drilling.
- Keep small parts away from children.



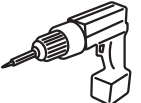







Tools required

Please remove all protective covering and examine carefully. Please notify the retailer immediately of any damage or faults. The manufacturer cannot be held responsible for any installation costs that may arise from damaged or faulty product being installed. The guarantee does NOT cover impact related damage. Please dispose all packaging with due regard to the environment.

<p>Spirit level</p> 	<p>Screwdriver</p> 	<p>Tape measure</p> 
<p>Pencil</p> 	<p>Junior hacksaw</p> 	<p>Silicon gun & sealant</p> 
<p>Power drill</p> 	<p>Drill bit*</p>  3mm dia. HSS	

* Ensure drill bit used is suitable for wall surface

Parts provided

<p>Pair of tubular cradles</p>  <p>x1</p>	<p>Cradle housing socket</p>  <p>x4</p>	<p>M10 Feet</p>  <p>x4</p>
<p>M8 Foot</p>  <p>x1</p>	<p>Centre foot bracket</p>  <p>x1</p>	<p>M10 Nuts</p>  <p>x8</p>
<p>M8 Nuts</p>  <p>x2</p>	<p>Wall brackets</p>  <p>x2</p>	<p>Transport screws/ Cradle securing screws (32mm)</p>  <p>x4</p>
<p>Fixing screws (23mm) To attach cradle sockets (If required see instruction 4)</p>  <p>x8</p>	<p>No.8 Domed self-tapping screws (16mm) To secure: - Centre foot bracket - Wall bracket - Cradle to socket</p>  <p>x8</p>	

We have taken great care to ensure that this product reaches you in perfect condition. However should any parts be damaged or missing please contact your point of purchase. This does not affect your statutory rights. In addition if you require replacement parts your point of purchase will be happy to assist.

STANDARD BATH PANEL FITTING INSTRUCTION

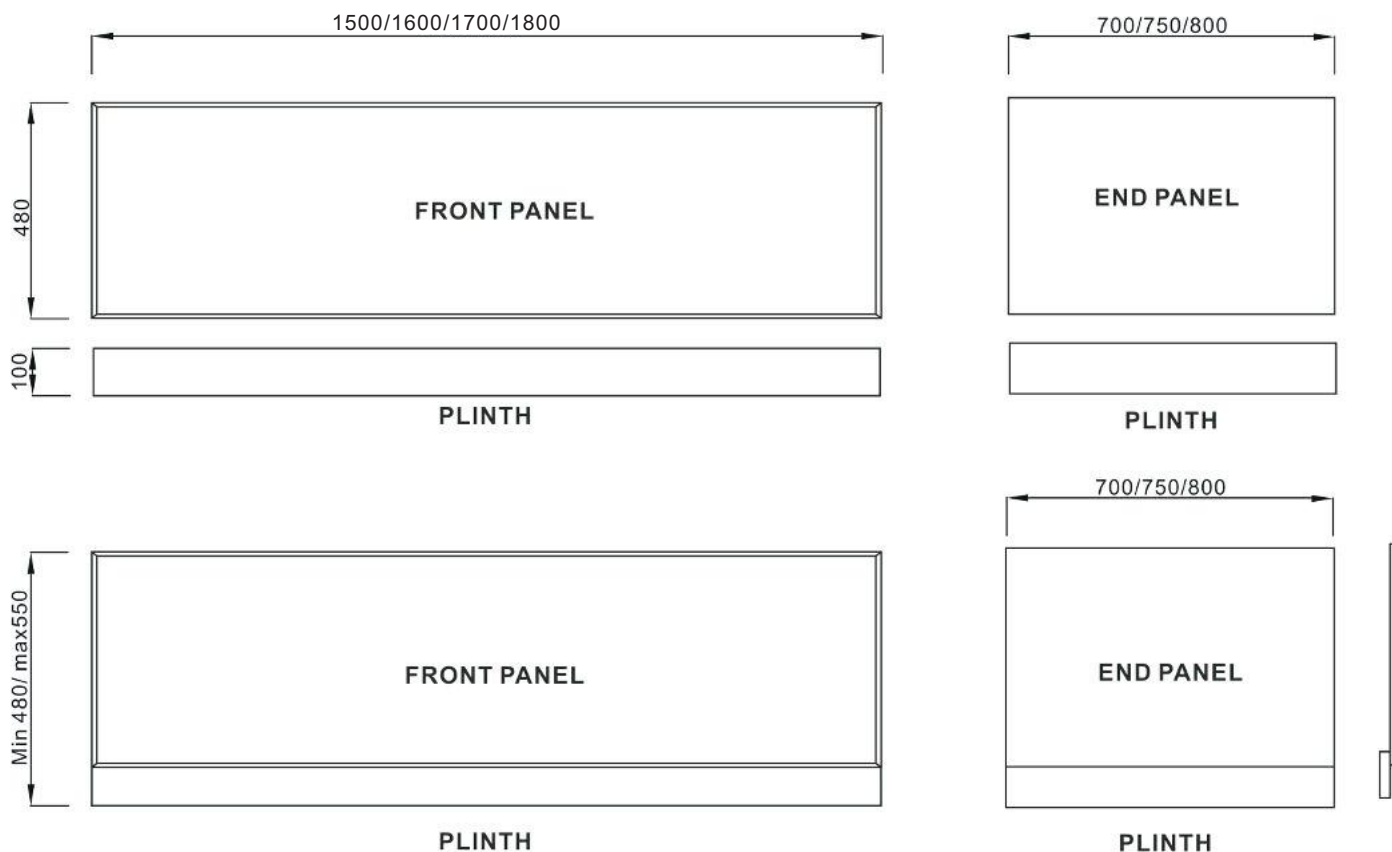

1. MEASURE FROM THE UNDERSIDE OF THE BATH RIM TO THE FLOOR TO ESTABLISH THE HEIGHT OF THE BATH PANEL REQUIRED.

2. DRILL EQUALLY SPACED HOLES ALONG THE PLINTH AND SCREW TO THE BOTTOM EDGE OF THE MAIN PANEL AT THE DESIRED HEIGHT.

3. IT IS ADVISABLE THAT YOU BUILD A FRAME OR FIT BATTENS ALONG THE FLOOR AND DOWN THE WALL SIDES TO SUPPORT THE PANEL.

4. WHEN AN END PANEL IS USED, IT IS NECESSARY TO TRIM THE PANEL & PLINTH TO LENGTH. ANY TRIMMING SHOULD BE DONE AT THE WALL END TO ENSURE THAT THE FINISHED EDGE IS AT THE VISIBLE CORNER. THE FRONT AND END PANELS ARE FASTENED TOGETHER USING THE SCREWS & CORNER BRACKETS PROVIDED.

5. ANY CUT OR TRIMMED EDGES MUST BE SEALED AGAINST WATER INGRESS. IT IS ALSO ADVISABLE TO SEAL ALL THE OUTER EDGES OF THE PANELS AND IN PARTICULAR THE UNDERSIDE OF THE BATH LIP WHERE THE PANEL MEETS.

SQUARE SHOWER BATH PANEL ASSEMBLY INSTRUCTIONS

1. Push the Cams into the pre-drilled holes in the back of panels A,B,C and D as shown below.
2. Screw into place the Cam pins as shown.
3. Push and glue in place the wooden dowels.
4. Glue all edges that are to be butted together, being careful not to get any adhesive on the decorative surfaces. Push the panels together one at a time and tighten by turning the Cams in a clockwise direction.
(any excess adhesive must be removed immediately with a damp cloth)
5. Fit the Corner Post between panels B and C. This can be fitted after the Bath has been installed if required.
6. Instruction shows the panel assembly for a L/H shower bath. For a R/H version assemble the panels in reverse.

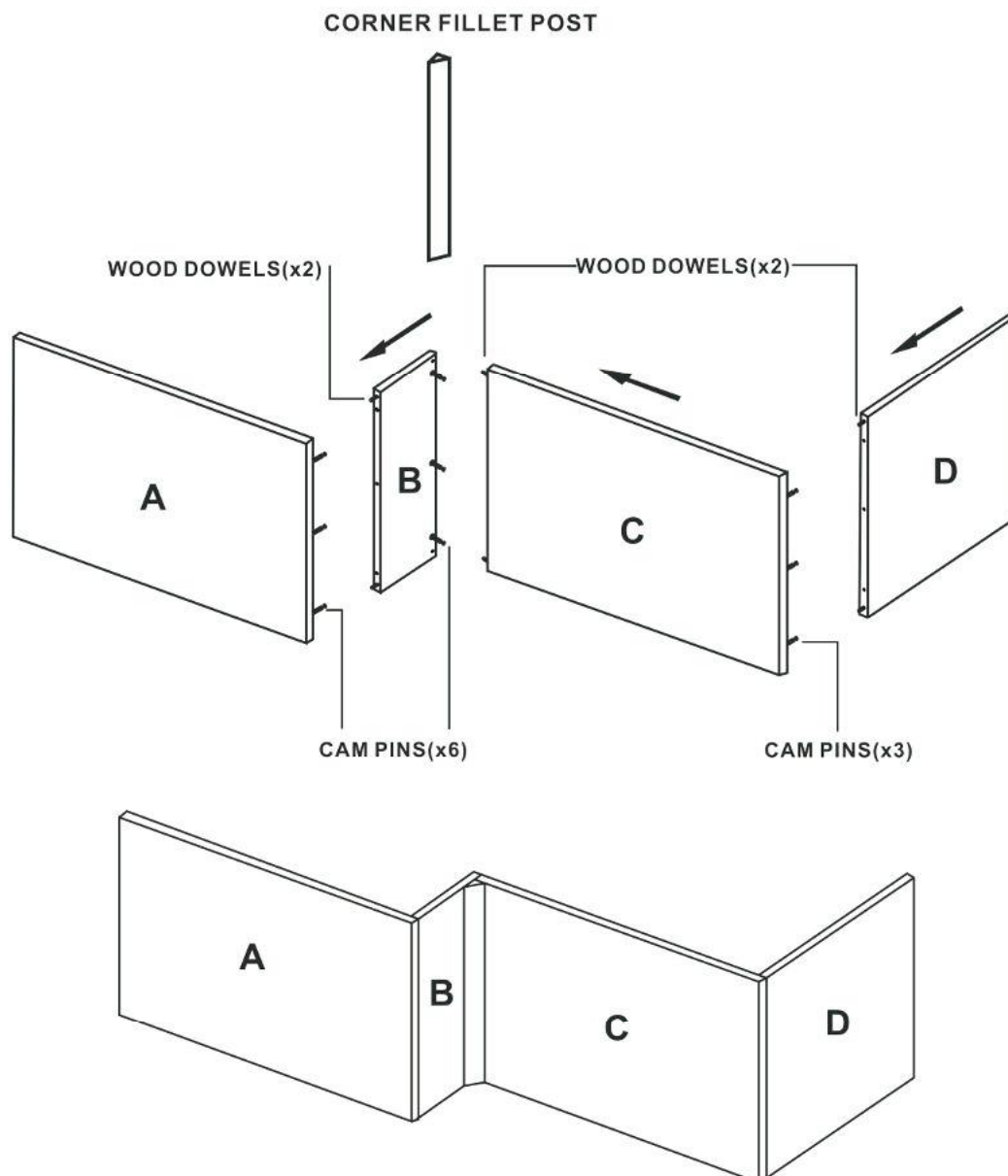

STANDARD BATH PANEL FITTING INSTRUCTION

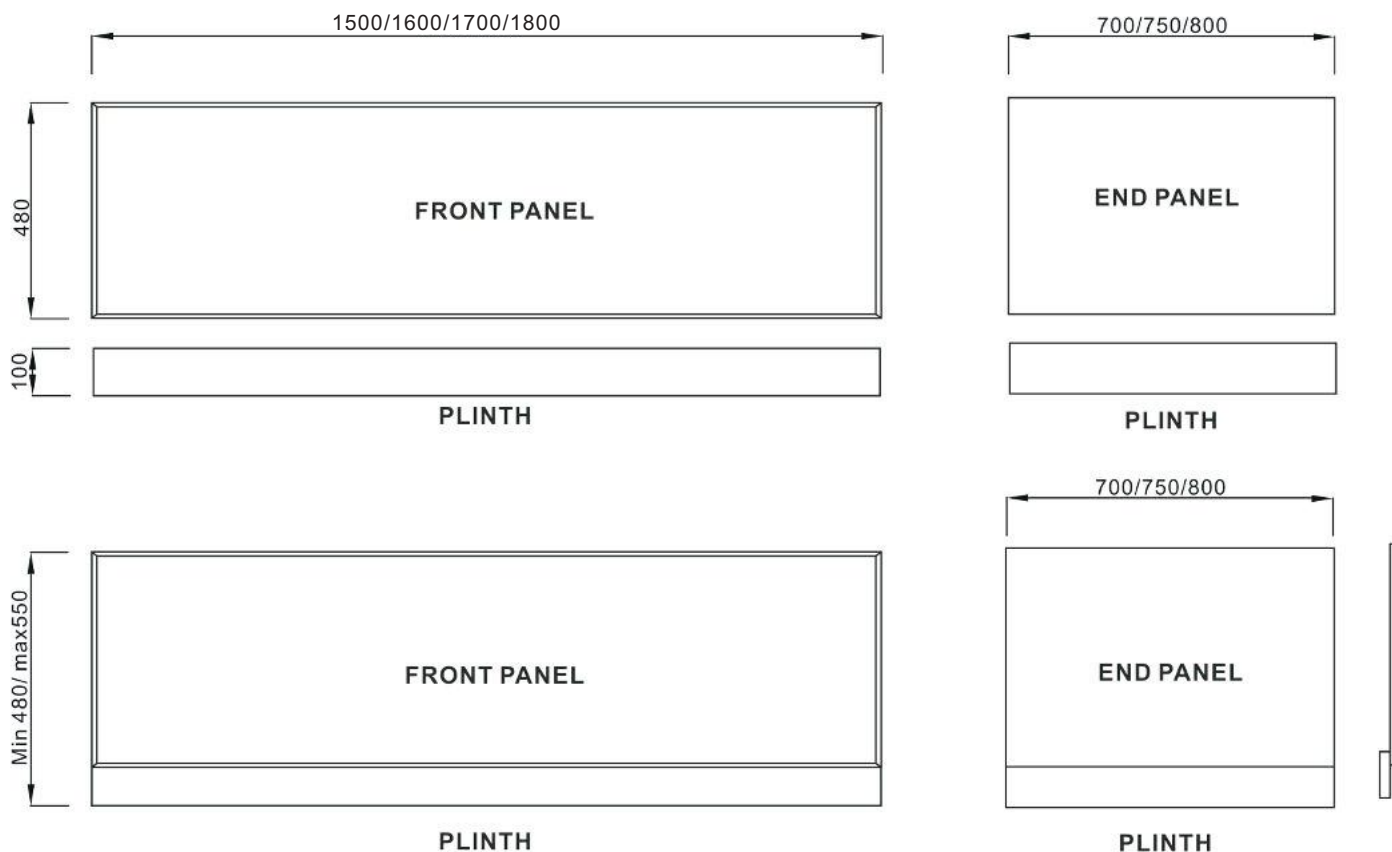

1. MEASURE FROM THE UNDERSIDE OF THE BATH RIM TO THE FLOOR TO ESTABLISH THE HEIGHT OF THE BATH PANEL REQUIRED.

2. DRILL EQUALLY SPACED HOLES ALONG THE PLINTH AND SCREW TO THE BOTTOM EDGE OF THE MAIN PANEL AT THE DESIRED HEIGHT.

3. IT IS ADVISABLE THAT YOU BUILD A FRAME OR FIT BATTENS ALONG THE FLOOR AND DOWN THE WALL SIDES TO SUPPORT THE PANEL.

4. WHEN AN END PANEL IS USED, IT IS NECESSARY TO TRIM THE PANEL & PLINTH TO LENGTH. ANY TRIMMING SHOULD BE DONE AT THE WALL END TO ENSURE THAT THE FINISHED EDGE IS AT THE VISIBLE CORNER. THE FRONT AND END PANELS ARE FASTENED TOGETHER USING THE SCREWS & CORNER BRACKETS PROVIDED.

5. ANY CUT OR TRIMMED EDGES MUST BE SEALED AGAINST WATER INGRESS. IT IS ALSO ADVISABLE TO SEAL ALL THE OUTER EDGES OF THE PANELS AND IN PARTICULAR THE UNDERSIDE OF THE BATH LIP WHERE THE PANEL MEETS.

SQUARE SHOWER BATH PANEL ASSEMBLY INSTRUCTIONS

1. Push the Cams into the pre-drilled holes in the back of panels A,B,C and D as shown below.
2. Screw into place the Cam pins as shown.
3. Push and glue in place the wooden dowels.
4. Glue all edges that are to be butted together, being careful not to get any adhesive on the decorative surfaces. Push the panels together one at a time and tighten by turning the Cams in a clockwise direction.
(any excess adhesive must be removed immediately with a damp cloth)
5. Fit the Corner Post between panels B and C. This can be fitted after the Bath has been installed if required.
6. Instruction shows the panel assembly for a L/H shower bath. For a R/H version assemble the panels in reverse.

