

## General Information

Please inspect the product immediately upon receipt for transit damage, missing packs or parts or damage.

Damages reported outside the time period advised during your purchase will not be accepted.

Please handle the product with care, avoiding knocks to the glass.

## Aftercare Instructions

After use, your shower screen should be cleaned with a clean damp cloth.

No abrasive cleaning agents or materials can be used, use of these will invalidate your guarantee.

### Tools Required

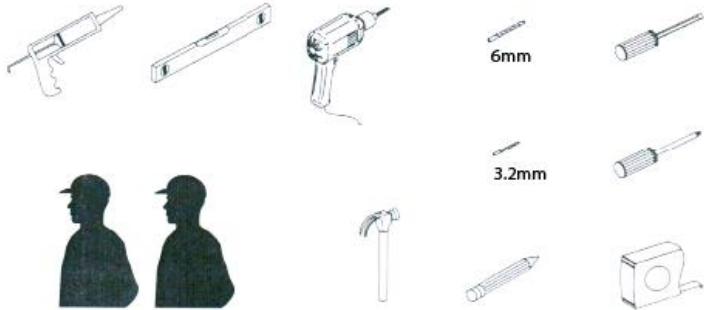

This product is heavy and may require two people to install.



Telephone : **0844 484 7678**

# Sliding Door Enclosure

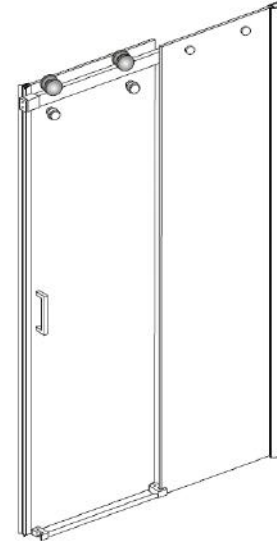

Please retain this manual after installation for future reference and maintenance.

Images are for installation purposes only.

### IMPORTANT

Handle with care, impact can damage both the glass and frame



Check for pipes and wires prior to drilling

Use of safety equipment is advised

Two people may be required for parts of the installation

## Parts

Part No	Description	Qty
1	Top horizontal rail	1
2	Installation guide	1
3	Door Handles	1 (2 piece)
4	Glass door guide	2
	Guide screw (M4 x 25)	2
	Screw plug	2
	Screw cap	2
5	Fixed glass fixing part	2 (2 piece)
6	Rail brackets	2
	Wall screws (M4x 35)	4
	Wall plugs	4
7	Rollers and anti-collision component	2
8	Wall channel screws (M4 x 35)	4
	Wall channel plugs	4
9	Profile screws (M4 x 10)	3
	Profile screw caps	3
10	Door/fixing panel vertical seal	2
	Door vertical seal	1
	Door horizontal seal	1
11	Chrome seal strip	1
12	Wall channel	1
13	Fixed glass panel inc chrome profile	1
14	Glass door	1

















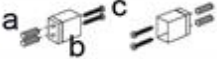

### **IMPORTANT - Please check the opening size prior to any installation**

1000 Enclosure fits into a space 960 - 980mm

1200 Enclosure fits into a space 1160 - 1180mm

1400 Enclosure fits into a space 1360 - 1380mm

## Box Contents

1 →		
2 →		
3 →		
4 →		
5 →		
6 →		
7 →		
8 →		
9 →		
10 →		 
11 →		
12 →		
13 →		
14 →		

## Assembly Diagram

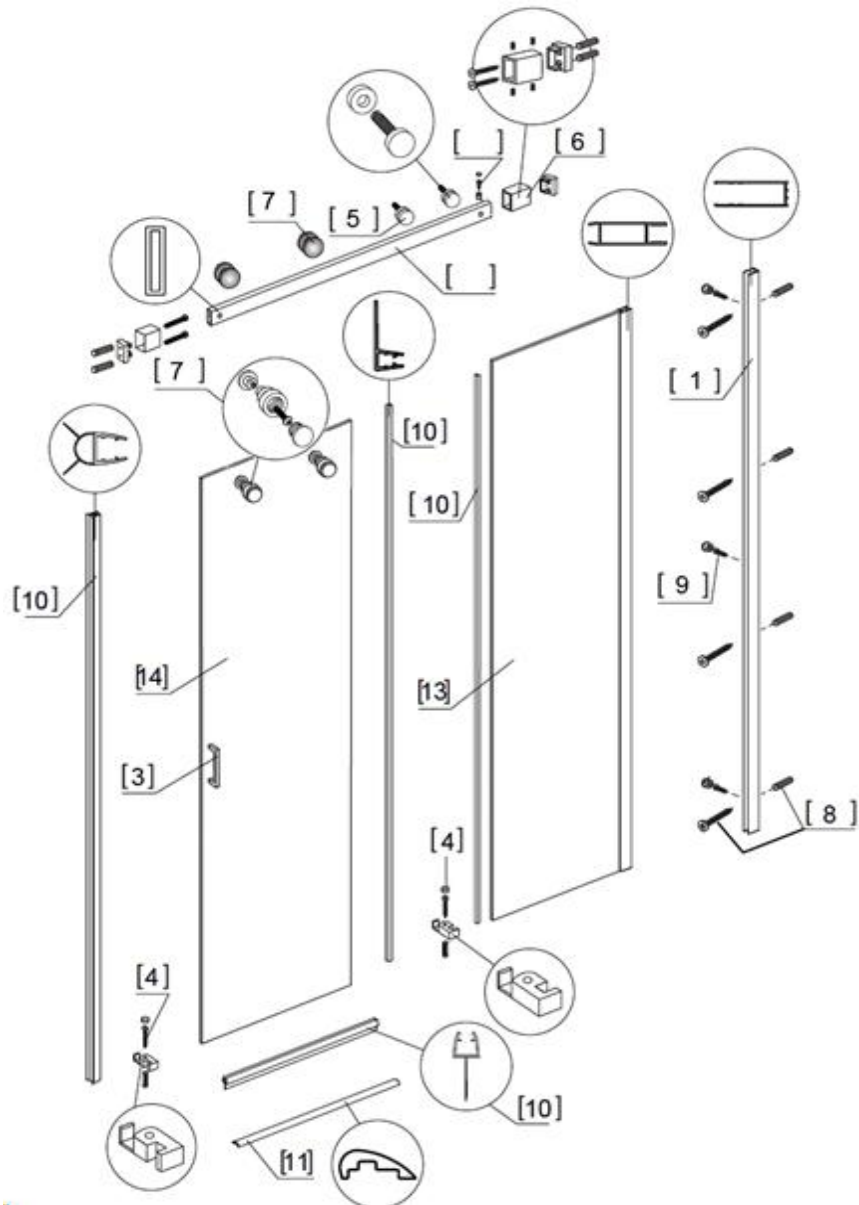

## Installation - Step 1

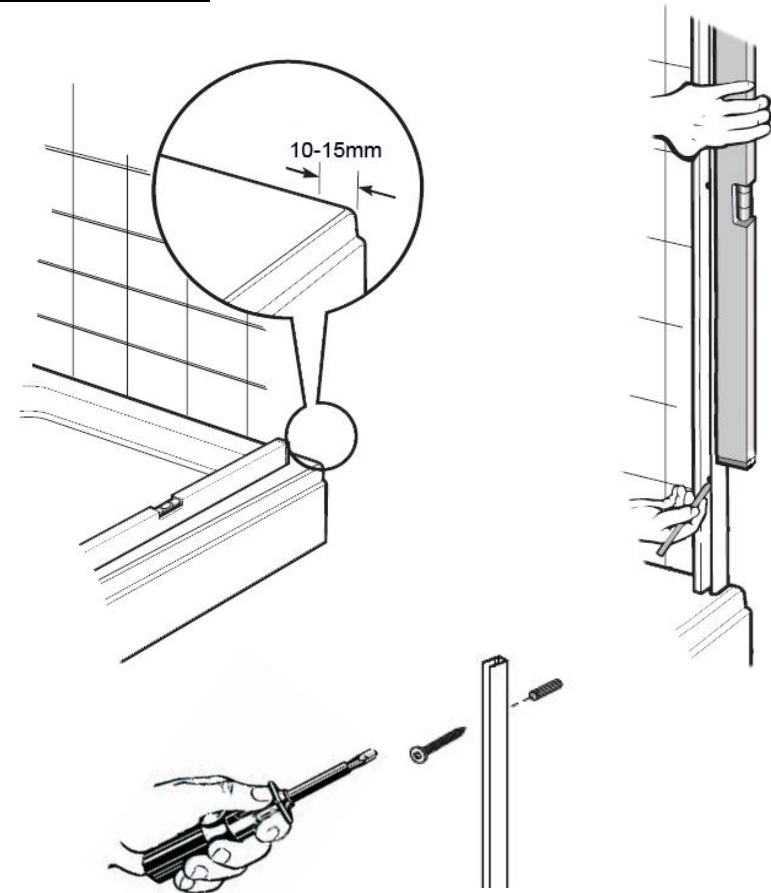

- The tray should be installed, tied down onto and sealed.
- Position the wall channel (12) onto the tray, we recommend 10-15mm in from the edge.
- Ensure the wall channel is vertical using a spirit level
- Mark the drill hole positions on the wall
- Before drilling ensure no pipes or wires will be damaged.
- Remove the wall channel, insert the wall plugs and screw wall channel to wall

## Installation - Step 2 (Fixed panel)

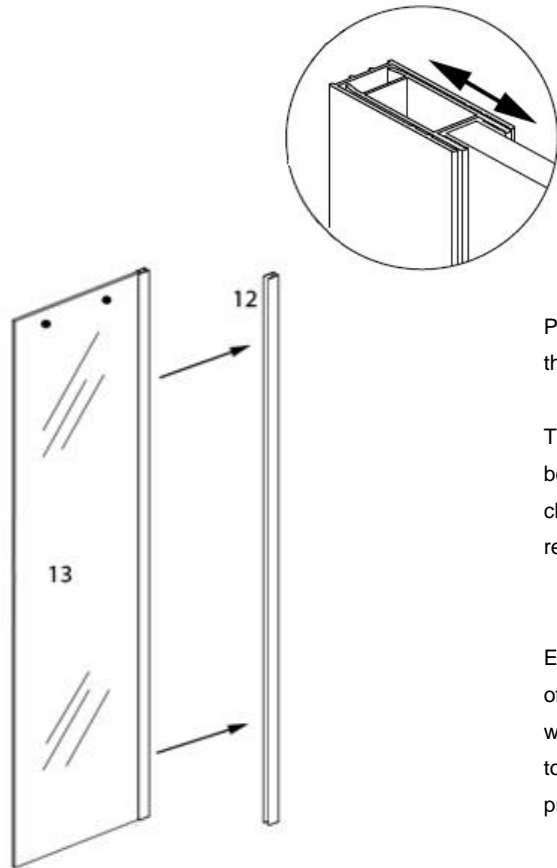

Push the glass panel (13) into the secured wall channel (12).

This is adjustable and can be located within the wall channel to achieve the required dimension.

Ensure that a sufficient amount of profile remains within the wall channel to secure these together with the screws provided.

## Installation - Step 3



Push the end brackets (6) into rail (1) at both ends

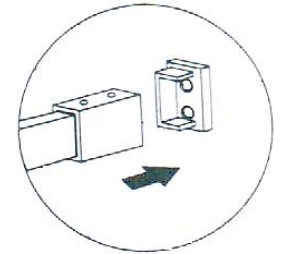

Offer the rail (1) up to the fixed screen (13) and align the holes in the rail with the holes in the screen and fit the fixing part (5) through the glass, do not tighten fully.

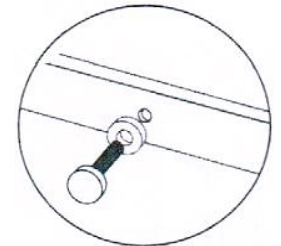

Mark the position of the bracket on the wall  
Ensuring the rail is level.  
Remove the rail from the glass panel and remove the brackets.

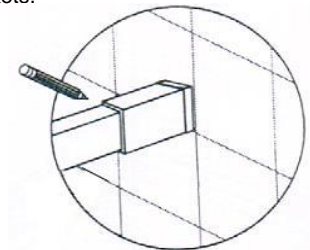

## Installation - Step 4



Hold the brackets (contained in part 6) against the mark on the wall and mark the drill holes.

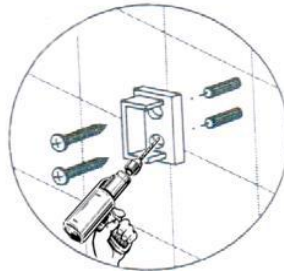

Remove the bracket and drill the holes

Insert the plugs.

Place the wall bracket over the holes and secure using the screws provided.

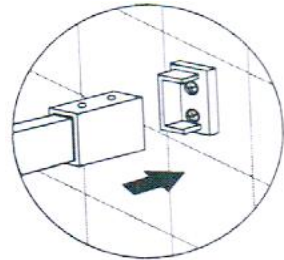

Slide the rail bracket onto the rail at each end and push these onto the wall brackets secured to the wall.

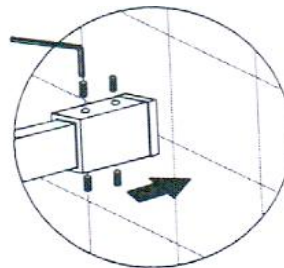

Secure the rail bracket to the wall bracket by tightening the allen screws fitted in the rail bracket, ensuring that the holes in the rail align with the holes in the screen.

## Installation - Step 5

Align the holes in the screen (13) with the holes in the rail (1) and secure using fixing parts (5)

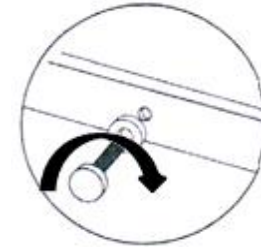

Part 5 - Fixing part

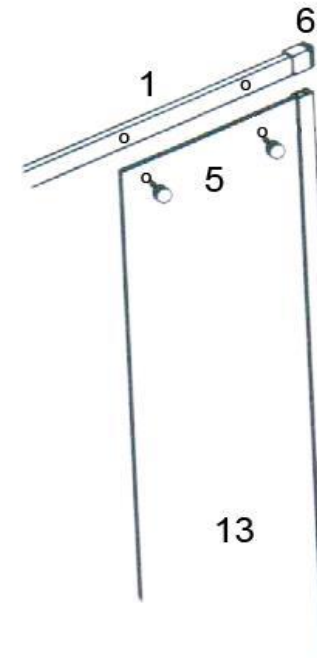

## Installation - Step 6

When the correct position has been achieved, drill from the inside of the wall channel, through the channel and glass profile, but NOT through to the outside.

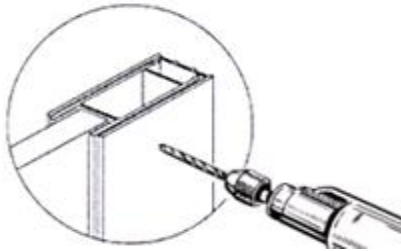

After drilling, secure the fixed panel into position, using the screws, cups and screw covers provided.

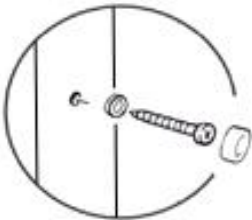
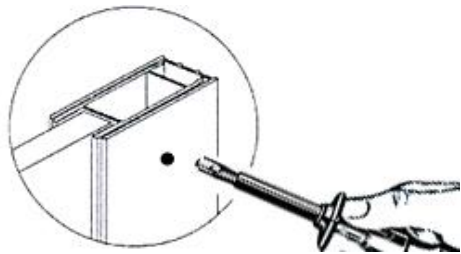

## Installation - Step 7

Please note : When fitting this enclosure to the tray drilling will be required to secure the glass door guide.

Locate the guide (4) on the edge of the fixed glass (13)

Drill the hole for the screw, do not use hammer on the drill, using a 3mm drill bit

Once drilled it is recommended to apply a small amount of silicone in the drill hole.

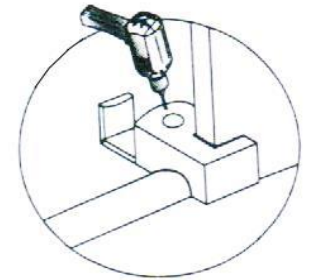

Screw the guide into position using the M4 x 25 screw and screw cover.

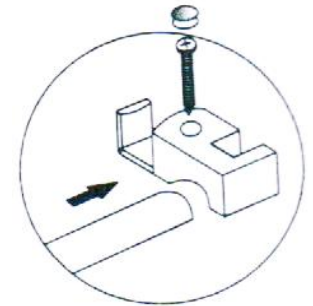

Slide the chrome strip (11) under the guide.

Locate the second guide at the opposite end of the strip and drill and screw as before

This second guide may be diferent if fitting with a side panel.

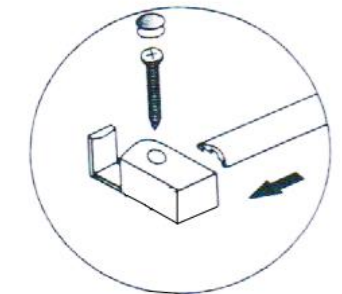

## Installation - Step 8

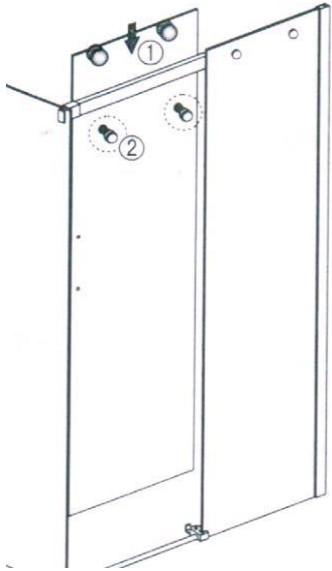

Dis-assemble the rollers (7b ) and anti-collision components (7a) to allow installation on to the door.

Offer the roller to the door, pass the thread through the door and secure into position ensuring free movement.

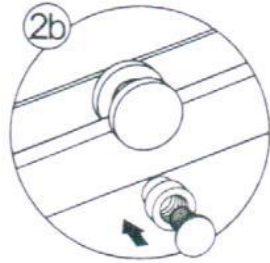

Hang the door onto the rail ensuring the rollers are engaged with the rail.

Offer the anti-collision components to the door holes, passing the thread through the door holes and secure into position.

## Installation - Step 9

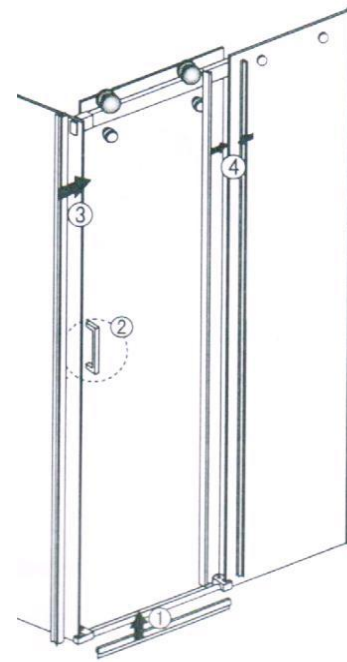

Fig 1 - Once the door has been fitted, push on the bottom door seal (10c)

Cut to size if required.

Fig 2 - Offer door handle (3) to the door, pushing the thread through the holes.

Connect the second section of the handle from the inside and secure using allen screws.

Fig 3 - Push on vertical door seal (10b) to the handle end of the door.

Fig 4 - Push on the vertical seals (10a) to both the door and the fixed screen, so that the fins meet when the door is closed

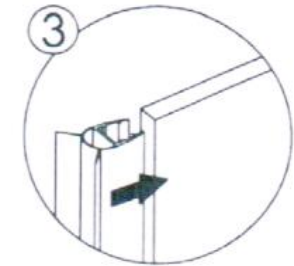
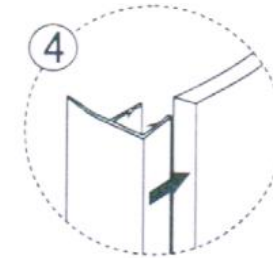
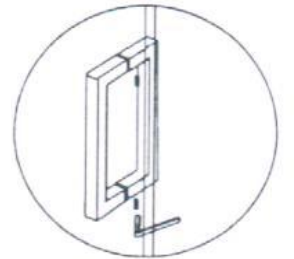
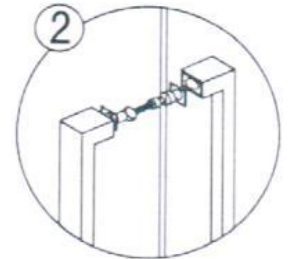
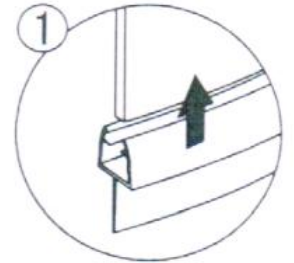
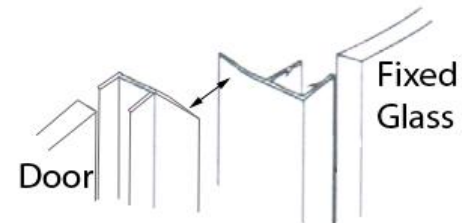

Sealing should be carried out along the bottom outer edge of the frame and up the outside of the wall channels.

Also seal along the outside edge of the fixed glass panel

**DO NOT seal on the inside of the enclosure.**

After sealing do not use the enclosure for at least 24 hours

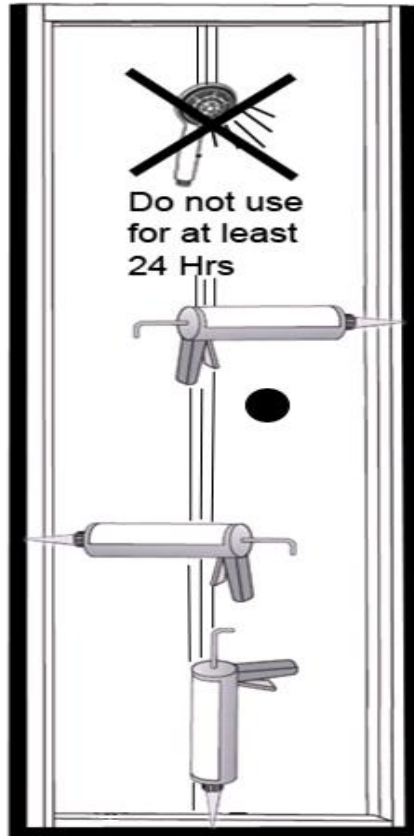

Your product comes with a guarantee when installed, used and cleaned in accordance with this manual.

**Not covered by the guarantee is:**

- The cost of repair or replacement of any accessories installed at the same time.
- The cost of routine maintenance, adjustments, overhaul, modifications, loss or damage, arising therefrom, including the cost of repairing damage, breakdown, malfunction caused by incorrect use, assembly or maintenance
- Breakdown due to -
  - a) Use other than domestic
  - b) Wilful act of neglect
  - c) Any malfunction resulting from incorrect use
  - d) Incorrect assembly/installation
- Repair costs for damage caused by foreign objects or substances
- Total loss of the product due to non-availability of parts
- Compensation for loss of use of the product or consequential loss of any kind.
- Call out charges where no fault has been found with the product.