

electriQ

INSTALLATION AND USER MANUAL



COOKER HOOD

	60cm hood	90cm hood
Stainless steel	eiQCURV60SC	eiQCURV90SC
Black	eiQCURV60BL	eiQCURV90BL
white	eiQCURV60WH	eiQCURV90WH

Please read this manual before using or installing the cooker hood and keep it safe for future reference.

Visit our page www.electriQ.co.uk for our entire range of electricals

CONTENTS

SAFETY	3
PARTS LIST	5
INSTALLATION	6
EXHAUST DUCT INSTALLATION	11
OPERATION	12
BULB REPLACEMENT	13
FILTER INFORMATION	14
GLASS CANOPY MAINTENANCE	15
CLEANING AND MAINTENANCE	16
TROUBLESHOOTING	17
TECHNICAL SPECIFICATION	18
SUPPORT	19
PRODUCT FICHE	20

IMPORTANT SAFETY INFORMATION

Please read this instruction manual carefully and retain for future reference. It contains important information concerning the safe operation, installation and maintenance of the appliance.

- There must be adequate ventilation of the room when the hood is used at the same time as appliances burning gas or other fuels.
- This cooker hood is only designed for domestic use, and should not be used in a commercial environment.
- Never use the hood for any purpose other than its intended use.
- Do not check the status of the filters during operation of the cooker hood.
- Do not touch the light bulb within 30 minutes of use.
- Do not flambé or excessively flame under the hood.
- Never leave frying food unattended as it can be a serious fire hazard.
- If the supply cord is damaged, it must be replaced by the manufacturer, its service agent or a similarly qualified person in order to avoid a hazard.
- The socket outlet for the hood must be located so it is easily accessible for the user after installation.
- Ensure the mains supply voltage corresponds with that of the appliance.
- There is a fire risk if cleaning is not carried out in accordance with the instructions.
- Ensure that the socket used provides adequate earthing of the appliance, if unsure professional advice must be sought.
- This appliance can be used by children aged from 8 years and above and persons with reduced physical, sensory or mental capabilities or lack of experience and knowledge if they have been given supervision or instruction concerning use of the appliance in a safe way and understand the hazards involved.
- Children must not play with the appliance.







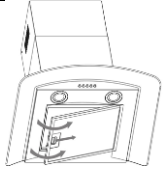

- Cleaning and user maintenance must not be carried out by children without supervision.
- When the hood is being maintained, cleaned or filters changed, make sure it is switched off at the mains supply.
- The exterior of the hood should be cleaned with mild detergent on a warm damp sponge or cloth.
- The air must not be discharged into a flue that is used for exhausting fumes from appliances burning gas or other fuels.
- Regulations concerning the discharge of air have to be fulfilled.
- The minimum distance between the supporting surface for the cooking vessels on the hob and the lowest part of the hood must be at least 65 cm.
- When the cooker hood is used in conjunction with appliances supplied with energy other than electric, the negative pressure in the room must not exceed 0,04 mbar to prevent fumes being drawn back into the room by the cooker hood.
- Failure to install the hood in accordance with these instructions may result in electrical hazards.

CAUTION:

Accessible parts may become hot when used with cooking appliances.

Deep fat fryers must be continuously monitored during use: overheated oil can burst into flames

PARTS

DESCRIPTION	ILLUSTRATION	QTY
Cooker Hood		1
Chimney Sections		2
Chimney bracket		2
Hood Installation Plate		1
Screw (ST5*50)		7
Wall plug		7
Screw (ST4.2*9.5)		6
Exhaust adaptor		1

INSTALLATION DIAGRAM

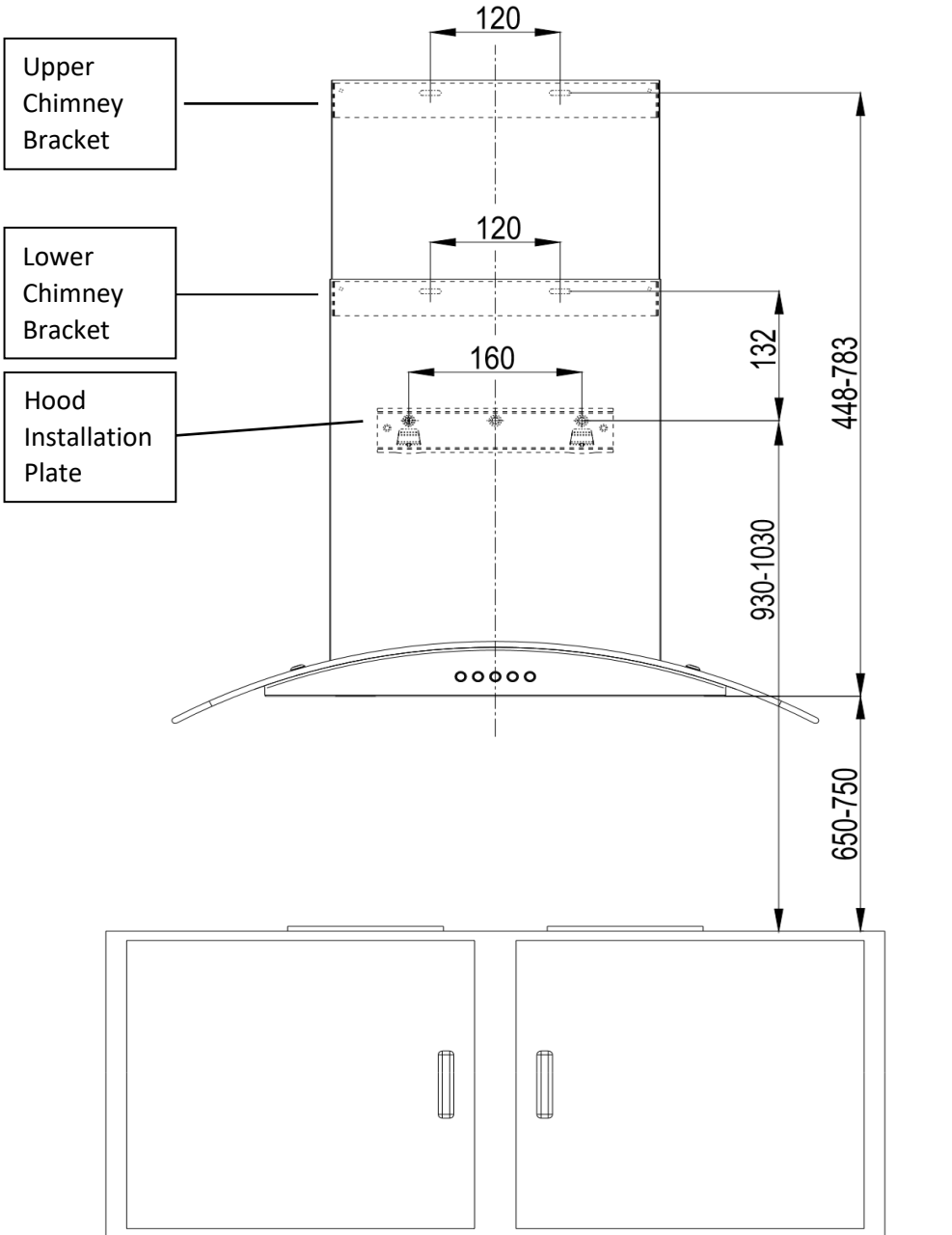

OPTIONS FOR VENTILATION

This hood can be set up for either external venting or recirculation of the air. The type of setup should be decided before commencing installation.

EXTERNAL VENTING

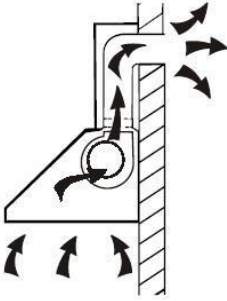

A 150mm diameter flexible pipe is provided which allows the cooking odours to be extracted outside. If this is the chosen installation method consideration to the route of the vent pipe should be made. The unit is also provided with an adaptor allowing pre-existing 120mm ducting to be used to vent the unit.

RECIRCULATION

This Cooker hood also supports the recirculation of the air once it has passed through the filters. The filtered air is then expelled through the vent holes in the side of the chimney.

When setting the unit up in this configuration, carbon filters should also be used to remove odours from the air. Details of sourcing and fitting the filters can be found in the Carbon filter section.

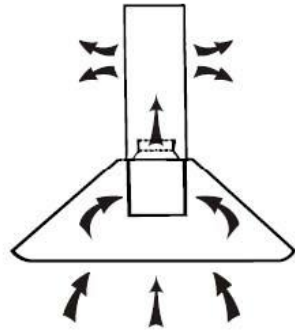

INSTALLATION

BEFORE INSTALLING YOUR HOOD:

- Unpack the hood and check that all functions are working. Ensure that the voltage (V) and the frequency (Hz) indicated on the serial plate match the voltage and frequency at the installation site.
- Check that the area behind the installation surface to be drilled is clear of any electrical cables or pipes, etc.
- The surfaces of the hood are very easily damaged during installation if grazed or knocked by tools. Please take care to protect the surfaces during installation.
- Protect the hob surface with cardboard, or similar, to prevent damage occurring whilst the hood is being installed above.
- The manufacturer shall not be liable for any failure to observe all safety regulations in force for the correct and normal operation of electrical products.
- Ensure the wall is level and the installation plates are horizontal to prevent grease from accumulating within the hood.
- Ensure the power has been turned off at the mains before starting installation.
- Connection to the mains supply must be in an accessible location.
- You may need the following tools to complete this installation:
 - Drill appropriate for your wall
 - Phillips Screwdriver
 - Tape Measure
 - Hand Saw or Jig Saw
- Electrical wiring must be done by a qualified person in accordance with all applicable codes and standards, including fire rated construction.

INFORMATION

- Sufficient air is needed for proper combustion and exhaustion of gases through the flue (chimney) for fuel burning equipment to prevent back drafting. Ductless fans must always be vented to the outdoors.
- When assessing the air pressure, the entire ventilation system in the house/apartment must be taken into account.
- All legal regulations must be observed for the conveyance of exhaust air. If the extractor hood is used in recirculating mode with the optional carbon filter, there are no operating restrictions.

1. Before installation, ensure you have not connected the appliance to the mains supply.

2. The cooker hood should be placed at a distance of 65~75cm above the cooking plane for best effect.

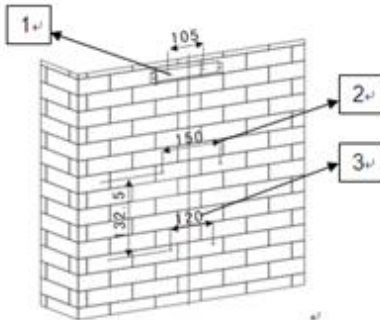
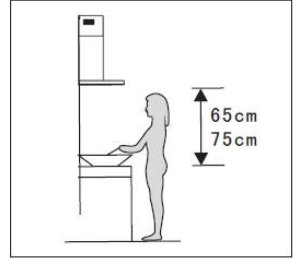

Pic 2

- After confirming the cooker hood height, measure the position of the holes for hanging the hood and inside chimney bracket. Drill 4 $\phi 8$ holes, 2 for inside chimney bracket and 2 for hanging the hood, and keep the hood level. The chimney bracket should be secured at the highest place of chimney.

- Screw two 4 x 30mm screws on the wall with wall plugs to fix the hood, then use two 4mm x 40mm screws to fix the inside chimney bracket. See Pic 2.
- Put the glass according to the lead direction and way on the cooker hood, and then use the screws to fix the glass. Install the outlet onto the hood.
- Then attach the outlet, converter and expansion pipe (IF USING) as shown below, and fix the pipe on the converter by cable tie, then lead the expansion pipe to the wall outlet. See pic 3.

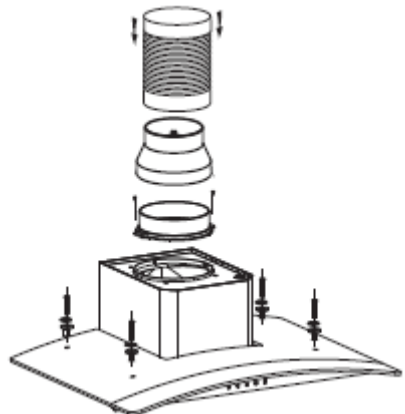

- Dress the inside chimney into the outside chimney. See Pic 4.
- Make the hood hang on the wall in the fixed position, adjusting the cooker hood position, fix the cooker hood with safety screws.

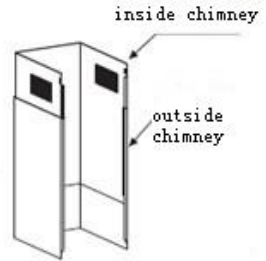

Pic 4

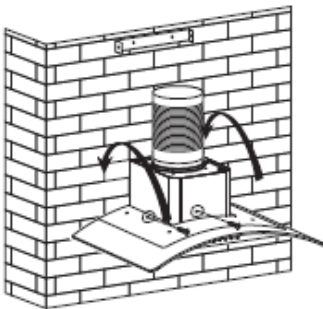

Pic 5

- The two safety vents are positioned on the back housing, with diameter of 6mm. See Pic 5.

- Put the two chimneys together onto the cooker hood body, meanwhile adjust the height of the inside chimney into the suitable height, and fix the inside chimney to the inside chimney bracket by screw, here should be sure the inside chimney can be flexed freely. See Pic 6.

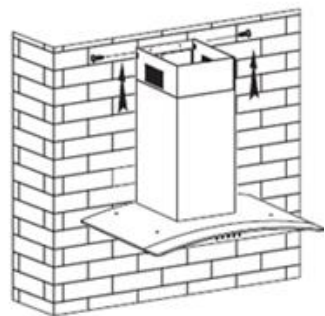

Pic 6

EXHAUST DUST INSTALLATION

The following rules must be strictly followed to obtain optimal air extraction:



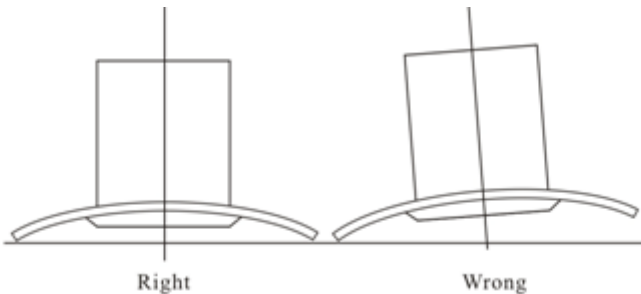

- Keep expansion pipe short and straight.
- Do not reduce the size or restrict expansion pipe.
- When using expansion pipe always install the pipe pulled taut to minimize pressure loss.
- Failure to observe these basic instructions will reduce the performance and increase noise levels of the cooker hood.
- Any installation work must be carried out by a qualified electrician or competent person.
- Do not connect the ducting system of the hood to any existing ventilation system which is being used for any other appliance, such as warmer tube, gas tube, hot wind tube.
- The angle of the bend of the expansion pipe should not be less than 120°; you must direct the pipe horizontally, or, alternatively, the pipe should go up from the initial point and should be led to an outer wall.
- After the installation, make sure that the cooker hood is level to avoid grease collection at one end.
- Ensure the expansion pipe selected for installation complies with relevant standards and is fire retardant.

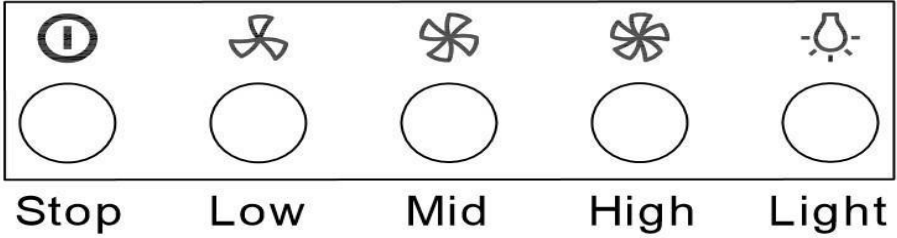

OPERATION

Operation of your hood is extremely simple. There are essentially 3 controls: Power Off; Fan Speed (3 separate buttons) and Illumination.



BUTTON	OPERATION
 Stop	Stops operation of the currently selected fan speed
 Low	Fan will run at low speed
 Mid	Fan will run at medium speed
 High	Fan will run at high speed
 Light	To turn the lights On and Off

REPLACING THE BULB

This hood is fitted with an LED light unit, which under normal operation can last the lifetime of the hood. In the event that it does fail, replacement light units are available from the same retailer the hood was purchased from.

Before changing the fitting, ensure the hood is turned off and the power is removed by either unplugging the unit or switching off at the pole switch (if installed) before attempting to change the bulb. Wait until the bulb has cooled down before commencing replacement.

1. Remove the glass canopy from the top of the hood, following the Removal and refitting of the glass canopy section.

2. Locate the top of the light fitting and squeeze the spring clips, while pushing the fitting out of the base of the hood.

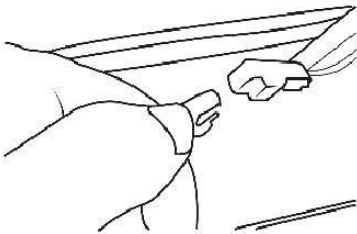
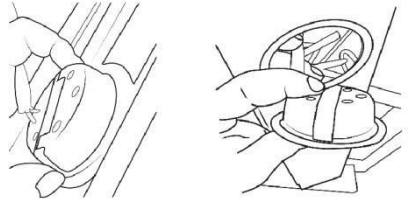

3. Follow the wire from the light unit and find the power connector on the lead.
4. Disconnect the power connector from it, ensuring the light fitting is not allowed to fall from the unit

5. Replace with a new light unit, which after connecting the electrical connection, should be pushed into position on the base of the hood.
6. Refit the glass canopy.
 - If a bulb is found to be defective, it should be replaced immediately.
 - Always switch off the electricity supply before carrying out any operations on the appliance. When handling the bulb, make sure it has completely cooled down before any direct contact to hands.

INSTALLING THE CARBON FILTER (OPTIONAL)

1. Remove the grease filters from the underside of the hood.
2. The carbon filters are located at either end of the motor.

TO FIT: Locate the filter on the peg on the side of the motor. Rotate the filter clockwise onto the motor housing;

TO REMOVE: Rotate the filter anti-clockwise until it is unscrewed.

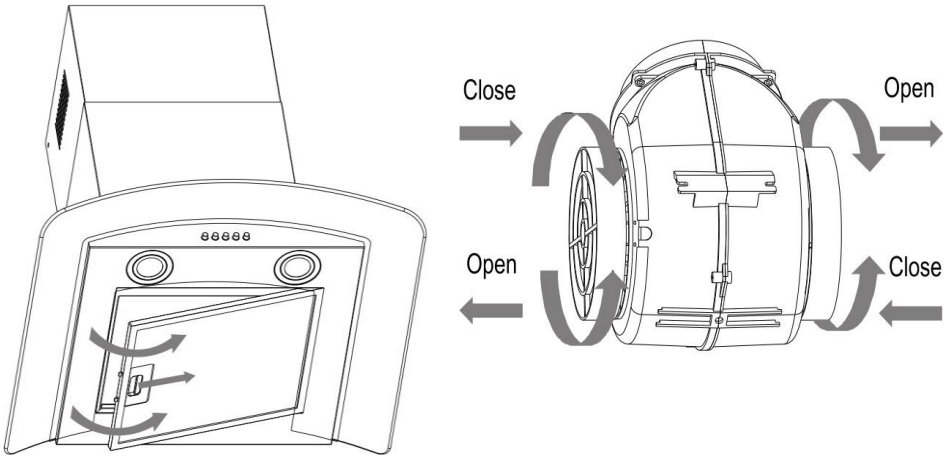

WARNING: The carbon filter cannot be washed or recycled. It should be replaced after approximately 2-3 months of use.

When the activated carbon filters are attached, the suction power will be reduced.

NOTE: The optional carbon filter is available from the hood supplier/manufacturer under the following stock code: eiQMIDCARBON

REMOVAL AND REFITTING OF THE GLASS CANOPY



WARNING: Components within the appliance may have sharp edges. When attempting to remove or refit the glass, gloves should be worn to avoid scratches and cuts.



The glass canopy is held into position using four screws, spacers and decorative washers. Remove the four screws, spacers and decorative washers from the glass canopy, ensuring the canopy is suitably supported. Two people should then lift the canopy off the hood, retaining the fittings removed for re fitting.

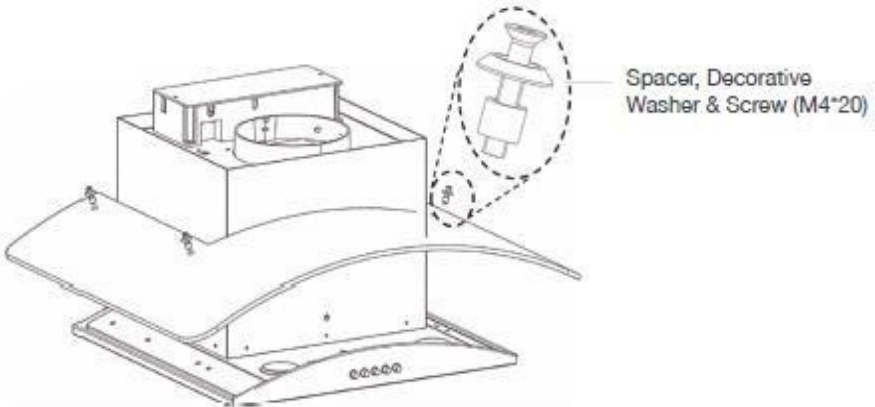

Refitting is the reverse of removal. Before refitting the hood, please ensure the decorative trim is correctly located, and has not become detached or displaced during disassembly.

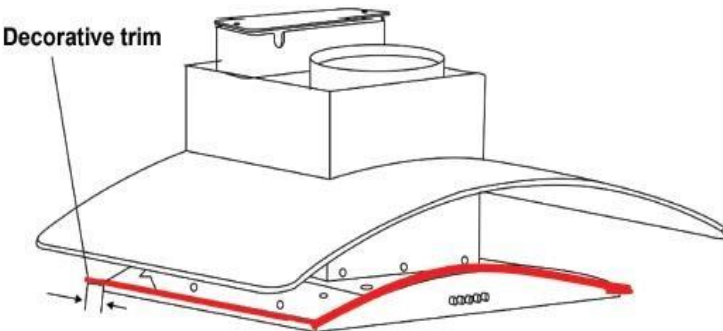

CLEANING AND MAINTENANCE

Disconnect range hood from power supply before cleaning or servicing.

1. Clean the hood surface frequently using mild detergent and a warm damp sponge or cloth.
2. Do not use harsh alkalis or abrasives.
3. Avoid the use of scouring powders or dishwasher compounds.
4. If the optional carbon filter is being used, these cannot be cleaned and require replacing every 2-3 months depending on frequency of use. They are available from the retailer who supplied your hood.

Information

Cleaning water must be kept away from the motor, control switch and all electrical components.

GREASE FILTERS

It is recommended that the grease filter is cleaned every two to three months by carrying out the following instruction:

1. Remove the grease filter from the cooker hood and wash it in a solution of warm water and neutral liquid detergent, leaving to soak.
2. Rinse thoroughly with warm water and allow to dry thoroughly before refitting.
3. The metallic filter may alter in colour after several washes.

There is a fire risk if cleaning is not carried out in accordance with the instructions.

Replacement grease filters are available under the following codes:

HOOD	GREASE FILTER
60cm Hoods	eiQM60CGFILTER
90cm Hoods	eiQM60CGFILTER

TROUBLESHOOTING

Fault	Cause	Solution
Light on, but fan does not work	The fan blade is jammed.	Switch off the unit. Repair to be carried out by qualified service personnel only.
	The motor is damaged.	
Both light and fan do not work	Power cord loose	Plug in to the power supply again.
Excessive Vibration	The fan blade is damaged.	Switch off the unit. Repair to be carried out by qualified service personnel only.
	The fan motor is not fixed tightly.	Switch off the unit. Repair to be carried out by qualified service personnel only.
	The unit is not hung properly on the bracket.	Take down the unit and check whether the bracket is in proper location.
Suction performance not good	<ol style="list-style-type: none"> Grease filters clogged Distance between the unit and the cooking plane too great. 	<ol style="list-style-type: none"> Clean or replace grease filters. Adjust the distance to between 70cm and 80cm.

SPECIFICATION

Voltage	220-240V~50Hz
Rated Power	108W
Lighting Power	2 X 1.5W
Motor Power	105W
Diameter of air tube	150mm
Air flow	400m ³ /h
Noise	≤6 dB5

The following shows how to reduce total environmental impact (e.g. energy use) of the cooking process).

- (1) Install the cooker hood in a proper place where there is efficient ventilation.
- (2) Clean the cooker hood regularly so as not to block the airway.
- (3) Remember to switch off the cooker hood light after cooking.
- (4) Remember to switch off the cooker hood after cooking.

INFORMATION FOR DISMANTLING

Do not dismantle the appliance in a way which is not shown in the user manual. The appliance could not be dismantled by user. At the end of life, the appliance should not be disposed of with household waste. Check with your Local Authority or retailer for recycling advice.

electriQ UK SUPPORT

www.electriQ.co.uk/support

Call: 0871 984 4416

Office hours: 9AM - 5PM Monday to Friday

www.electriQ.co.uk

Unit J6, Lowfields Business Park
Lowfields Way, Elland
West Yorkshire, HX5 9DA



Recycling facilities are now available for all customers at which you can deposit your old electrical products. Customers will be able to take any old electrical equipment to participating sites run by their local councils. Please remember that this equipment will be further handled during the recycling process, so please be considerate when depositing your

equipment. Please contact the local council for details of your local household waste recycling centres.

PRODUCT FICHE

Model Identification	eiQCURV60SC eiQCURV60BL eiQCURV90SC eiQCURV90BL eiQCURV60WH eiQCURV90WH		
	Symbol	Value	Unit
Annual Energy Consumption	AEChood	53.2	kWh/A
Standard Annual Energy Consumption	SAEChood	65.0	kWh/a
Time increase factor	F	1.6	
Fluid Dynamic Efficiency	FDEhood	11.0	
Energy Efficiency Index	EELhood	81.8	
Measured air flow rate at best efficiency point	QBEP	244.2	m ³ /h
Measured air pressure at best efficiency point	PBEP	142	Pa
Maximum air flow	Qmax	423.6	m ³ /h
Measured electric power input at best efficiency point	WBEP	87.4	W
Nominal power of the lighting system	WL	1.5W x 2	W
Measured power of the lighting system	WL	3.0	W
Measured value of the Lighting Efficiency	LEhood	59	Lux/W
Average illumination of the lighting system on the cooking surface	Emiddle	177	lux
Measured power consumption in standby mode	Ps	--	W
Measured power consumption off mode	Po	0	W
Tested according to EN 50564:2011			
Sound power level	LWA	Minimum speed:57 Maximum speed: 65	dB
Tested according to EN 60704-2-13:2011, EN 60704-1:2010 + A11:2012			