

## INTRODUCTION

Thank you for choosing a De'Longhi product. Please take a few moments to read the instructions to avoid risks or damage to the appliance.

Download the App!



This appliance can be used also with the APP named "Delonghi Comfort" that can be downloaded from the App Store® or from Google Play.

To gain access to all functions you need a local net (Home WLAN) with access to Internet. Further check there are no obstacles to the Internet access, such as Firewall, Proxy, authentications, etc. Through the App you can easily control Pinguino from home or outside

## DESCRIPTION

### Description of the appliance (see page 3 - A)

- A1 air outlet grille
- A2 control panel
- A3 handles
- A4 castors
- A5 BioSilver filter
- A6 air intake grille
- A7 air exhaust hose housing
- A8 air intake grille
- A9 power cable
- A10 drainage hose with cap
- A11 remote control signal receiver
- A12 remote control compartment

### Description of the accessories (see page 3 - B)

- B1 wall flange with cap
- B2 air exhaust hose
- B3 hose adaptor
- B4 adapter for window bracket
- B5 window bracket with wing nut
- B6 adapter for wall mounting/window outlet
- B7 window outlet
- B8 remote control
- B9 window bracket cap

## ELECTRICAL CONNECTION

Before plugging into the mains, check the following:

- the mains voltage is the same as that indicated on the plate

on the back of the appliance;

- the socket and electrical line are sized to support the load required;
- the socket is the proper type for the plug, otherwise, replace the socket;
- the socket is connected to an efficient earthing system. The manufacturer is not responsible in the event of non-compliance with these injury prevention standards.
- **The power cable must only be replaced by specialised technicians.**

## USE

The instructions below will enable you to prepare your air conditioner for operation as efficiently as possible. Before use, make sure the air intake and outlet grilles are unobstructed.

**Please note:** This appliance is provided with an auto-evaporation feature for condensate removal during cooling and dehumidifying modes.

## AIR CONDITIONING WITHOUT INSTALLATION

### CASEMENT WINDOW

If you have a casement window proceed as follows:

- Fit the air exhaust hose (B2) in the relevant housing located on the rear side of the appliance (fig. 1).
- Screw the window outlet (B7) and place outside the window to exhaust the hot air (fig. 2).

### DOUBLE-HUNG WINDOW

If you have a double-hung window proceed as follows:

- Insert and lock the adapter for window bracket (B4) into the slot of the window bracket (B5) (fig.3)
- Place the window bracket in the window sill, and extend the bracket fully within the window frame (fig. 4).
- Fix the bracket by the wing nut (fig. 5) (Should the window bracket be too large for the window the plastic can be cut with a saw by a qualified professional).
- Insert the air exhaust hose (B2) into the adapter for window bracket (B4) and rotate it as shown in fig. 6.
- In order to facilitate the fitting of the air exhaust hose (B2) in the relevant housing located on the rear side of the appliance, position the hose adapter's tabs (B3) in a horizontal axis as shown in fig. 7 and proceed as shown in fig.1.

### SLIDING WINDOWS

- Thanks to the locking wing nut, it's possible to use the window bracket also for sliding windows. Position the bracket vertically with the hole in the lower part so to allow a correct installation of the exhaust hose.

## AIR CONDITIONING WITH INSTALLATION

- Fit the air exhaust hose (B2) in the relevant housing located on the rear side of the appliance (fig. 1).
- Drill a hole 150 mm in an outside wall or through a window panel. Respect the distances, dimensions and height of the hole given in figure 8.

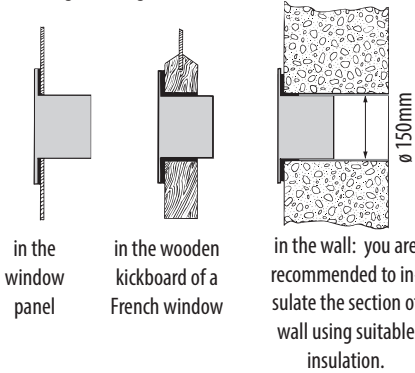

- Fit the wall flange (B1) into the hole.
- Fit the air exhaust hose (B2) into the wall flange (B1) (Fig. 9)
- When the hose (B2) is not connected, the drilled hole can be closed with the flange cap (B1).

**Please note:** As special tools are required for installation, we suggest you have the appliance installed by specialized personnel.

- When installing the air conditioner, you should leave a door slightly open little as 1 cm to guarantee correct ventilation and room pressure.
- Keep the air hose as short and free of curves as possible to avoid constrictions.

## OPERATING FROM THE CONTROL PANEL

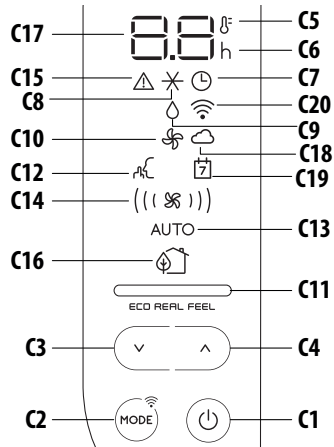

### DESCRIPTION OF THE CONTROL PANEL (C)

- C1** ON/STAND-BY (on/off) key
- C2** Function selection key MODE (air conditioning, dehumidifying, fan, ON-OFF Wi-Fi - reset WLAN settings)
- C3** Decrease key
- C4** Increase key
- C5** Temperature indicator
- C6** Timer indicator
- C7** Timer symbol
- C8** Air conditioning symbol
- C9** Dehumidifying symbol
- C10** Fan symbol
- C11** ECO REAL FEEL indicator
- C12** SILENT symbol
- C13** Auto indicator
- C14** Air flow indicators
- C15** Alarm symbol
- C16** ECO REAL FEEL symbol
- C17** Set temperature values, programmed on/off time
- C18** App Indicator
- C19** App timer/calendar
- C20** Wi-Fi symbol

## TURNING THE APPLIANCE ON/OFF

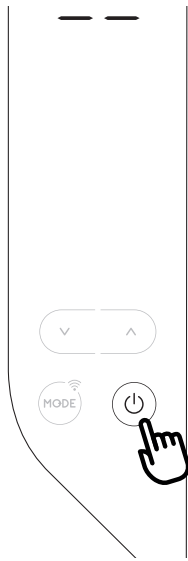

Before plugging the appliance check the cap on back of the unit is correctly inserted on drainage hose (A10). Insert the plug in the socket.

Two dashes appear on the display indicating that the appliance is in stand-by.

Touch the  (C1) key to turn on the appliance.

When the appliance comes on, the last function set before it was shut off is activated.

**Please note:** After few seconds of the control panel inactivity, its brightness will be automatically reduced and in the next few minutes it will be further reduced.

To turn the appliance off, touch the  (C1) key again.

**Please note:** Never turn off the air conditioner by simply pulling the plug. Touch the  (C1) key in order to put your air conditioner in stand-by and wait a few minutes before pulling the plug. In this way, the appliance can perform the operating status checks.

## MODES SELECTION

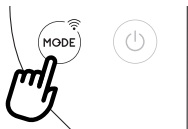

To select the desired operating mode, touch repeatedly the MODE key (C2) until the desired function is selected.

## Wi-Fi FUNCTION (From the control panel)



To select or deselect the Wi-Fi function, keep touching the MODE key for 3 seconds.

Once the Wi-Fi icon is displayed it means that the following Wi-Fi features are available:



### SYMBOL WI-FI FIXED

it means that the Wi-Fi features are active AND the "Home WLAN" has been found.



### SLOW FLASHING

it means that the appliance is searching for the "Home WLAN" .\*



### FAST FLASHING



it means that the "Home WLAN" has not been found or has not been set yet.



### "APP CONTROL" ICON

When the APP CONTROL icon appears it means that the last command has been received via app.

If the memorized "Home WLAN" settings needs to be changed, proceed as follows:

- keep touching for about 20 seconds the MODE button C2 on the control panel until a prolonged beep is emitted;
- the icon  and  blink simultaneously.
- use the app to enter the new WLAN settings into the unit.

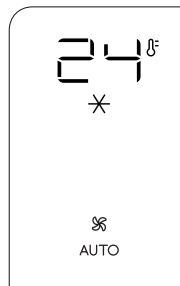

**\* Note:** In standby, the search for "Home WLAN" stops after approximately 1 hour. It will resume once the appliance is turned on again.

## ✕ AIR CONDITIONING MODE



This is ideal for hot and humid weather when the room needs to be both cooled and dehumidified.

To correctly set this mode:

- Touch repeatedly the MODE key (C2) until the air conditioning ✕ symbol appears. The display will show the desired temperature and the AUTO fan speed.
- To change the temperature to be reached, touch the  (C4) or  (C3) key.

**Please note:** The most suitable temperatures, during the summer range from 24 to 27°C. However, setting the temperature significantly lower than the outdoor temperature is not recommended.

In conditioning mode, the air flow can be selected only from the remote control.

## △ DEHUMIDIFYING MODE



AUTO

This is ideal for reducing humidity in the room (spring and autumn, damp rooms, rainy periods, etc). For this type of use, the appliance must be set up as for air conditioning mode. That is, the air exhaust hose (B2)

must be fitted to the appliance to allow the humidity to be discharged outside.

To correctly set this mode:

- Touch repeatedly the MODE key (C2) until the dehumidifying △ symbol appears.
- The appliance automatically chooses the best air flow.

## 🌀 FAN MODE



When using this mode, the air exhaust hose (B2) does not need to be attached to the appliance.

To correctly set this mode:

- Touch repeatedly the MODE key until the fan 🌀 symbol appears.
- Select the desired air flow by touching the increase ^ (C4) or decrease v (C3) key.

The air flows available are:

- ( 🌀 ) **Minimum air flow:** when most silent operation is desired.
- (( ( 🌀 )) **Medium air flow:** when the noise level needs to be low but with a good comfort level.
- (( ( 🌀 )) **Maximum air flow:** for maximum performance.

## SELECT THE TEMPERATURE SCALE

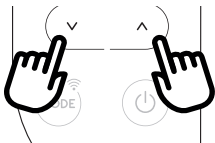

The temperature can be displayed in °C or °F. To change the temperature unit of measure touch both the the increase ^ (C4) or decrease v (C3) key keys for about 10 sec.

## OPERATING FROM THE REMOTE CONTROL

### INSERTING OR REPLACING THE BATTERIES

- Remove the cover on the rear of the remote control;
- Insert or replace the batteries with two new LR03 "AAA" 1.5V batteries, inserting them correctly (see the directions inside the battery compartment) (fig. 10);
- Replace the cover.

**Please note:** If the remote control unit is replaced or discarded, the batteries must be removed and disposed of in accordance with current legislation as they are harmful to the environment.

Do not mix old and new batteries.

Do not mix alkaline, standard (carbon-zinc) or rechargeable batteries. Do not dispose of batteries in fire. Batteries may explode or leak. If the remote control is not be used for a certain length of time, remove the batteries.

## USING THE REMOTE CONTROL

- Point the remote control at the receiver (A11) on the air conditioner. The remote control must be no more than 7 metres away from the appliance (fig. 10) (without obstacles between the remote control and the receiver).
- The remote control must be handled with care. Do not drop it or expose it to direct sunlight or sources of heat.

**Please note:** The remote control can be safely stored in the appropriate compartment (A12).

## Wi-Fi FUNCTION (From the remote control)

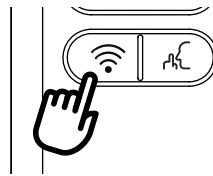

To activate or deactivate the Wi-Fi function, on the remote control keep touching the Wi-Fi button for a few seconds until the emission of a double beep.



Once the Wi-Fi icon is displayed it means that the Wi-Fi features are available: (see page 14)

## DESCRIPTION OF THE REMOTE CONTROL

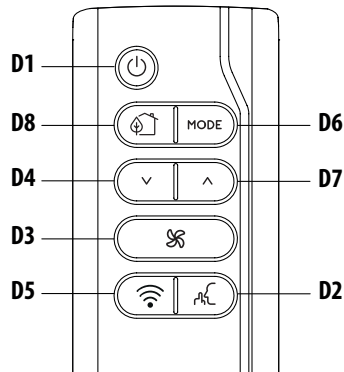
- D1) ON/STAND-BY button
- D2) Silent button
- D3) Air flow
- D5) Wi-Fi button
- D6) MODE button
- D4-D7) Increase/Decrease button
- D8) ECO REAL FEEL button



## TURNING THE APPLIANCE ON/OFF

- Plug into the outlet.
- Press the  button (D1) (when turned on, the air conditioner starts operating in the same mode as when it was turned off).
- To switch the appliance off, press the  button (D1).

**Please note:** Never switch the appliance off by removing the plug.



Always switch it off by pushing the  button (D1) and waiting few minutes before removing the plug. Only in this way the appliance will perform the standard checkings.

## SELECTING THE OPERATING MODES

To select the desired operating mode, touch repeatedly the MODE button (D6) until the desired function is selected.

Most of the commands available on the remote control correspond to those on the appliance control panel (C).

## SELECTING THE TEMPERATURES

In conditioning modes press  (D4) and  (D7) buttons to decrease/increase the desired temperature.

## SELECTING THE AIR FLOW

In conditioning and fan modes, press  (D3) button to increase/decrease the desired air flow.

## SILENT FUNCTION (available in conditioning mode only)

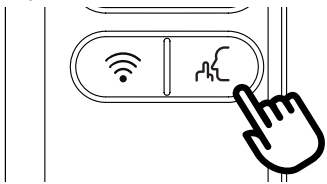

By activating this function, the operating noise is further reduced. To activate it, press  (D2) button on the remote control. The display shows the relative symbol (C12).

## SETTING THE TIMER

Timer programming is an exclusive function of the app: thanks to the many possibilities of timer programming, you can prevent wasting electricity by optimizing the operating period with weekly scheduling, setting delayed start up or shut down of the appliance.

## ECO REAL FEEL FUNCTION

ECO REAL FEEL is the innovative De'Longhi technology that works simultaneously on temperature reduction and humidity

control, securing best comfort level.

With traditional systems, during working time, optimal comfort conditions may be reached but not secured over time. With ECO REAL FEEL, once optimal comfort is reached, PAC automatically modulates compressor action and air flow, to keep it over time. To activate the function, press the Eco Real Feel button (D8). The ECO REAL FEEL symbol (C16) appears.

**Please note:** For this type of use, the appliance must be set up as for air conditioning mode.

After approx. 1 minute, the ECO REAL FEEL indicator (C11) turns on. It changes color when approaching the best comfort level (see following diagram).

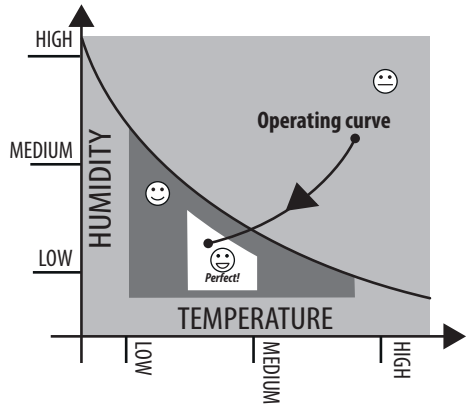

 **ORANGE LIGHT:** Room conditions far from optimal level.

 **GREEN LIGHT:** Most people feel good room conditions, near optimal level.

 **BLUE LIGHT:** Best comfort level.  
*Perfect!*

- The well-being feeling is a subjective condition. For this reason, different people may judge differently the same environmental conditions.
- In particularly severe environmental conditions (large size of the environment, high temperature or humidity outside, poor insulation of the room, too many of people or strong heat load in the room, strong exposure to the sun ...) this device may not be able to reach the best comfort level.

## SELF-DIAGNOSIS

The appliance has a self diagnosis system to identify a number of warning/malfunctions. Error messages are displayed on the appliance display.

<p><b>IF ... IS DISPLAYED,</b></p> <p><b>LT</b></p> <p>“Low Temperature” (frost prevention)</p> <p><b>..WHAT SHOULD I DO?</b></p> <p>The appliance is fitted with a frost protection device to avoid excessive formation of ice. The appliance starts up again automatically when the defrosting process is completed.</p>	<p><b>IF ... IS DISPLAYED,</b></p> <p><b>LH</b></p> <p>Low humidity</p> <p><b>..WHAT SHOULD I DO?</b></p> <p>This message will only be displayed when Real Feel function, indicating that the room humidity level is extremely low. To resume operation, switch the unit to any other mode other than the Real Feel function.</p>	<p><b>IF ... IS DISPLAYED,</b></p> <p><b>PF</b></p> <p>⚠</p> <p>Probe Failure (Probe damaged)</p> <p><b>..WHAT SHOULD I DO?</b></p> <p>If this is displayed, contact your local authorized service center.</p>	<p><b>IF ... IS DISPLAYED,</b></p> <p><b>HL</b></p> <p>⚠</p> <p>“High Level” (Internal tray full)</p> <p><b>..WHAT SHOULD I DO?</b></p> <p>Empty the internal safety tank following the instructions in the section “End of season operations”.</p>	<p><b>IF ... IS DISPLAYED,</b></p> <p><b>EI</b></p> <p>“Communication Failure” (Internal communication issue)</p> <p><b>..WHAT SHOULD I DO?</b></p> <p>If this is displayed, contact your local authorized service center.</p>
--	---	--	---	--

## TIPS FOR CORRECT USE

To ensure optimal results from your air conditioner, follow these recommendations:

- close the windows and doors in the room to be air conditioned. When installing the air conditioner semi-permanently, you should leave a door slightly open (as little as 1 cm) to guarantee proper ventilation.
- Never use the appliance in very damp rooms (laundries for example).
- Protect the room from direct exposure to the sun by partially closing curtains and/or blinds to make the appliance much more economical to run.
- Never use the appliance outdoors.
- Make sure there are no heat sources in the room.
- make sure the air conditioner is standing on a level surface.

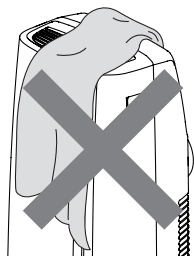

*do not cover the appliance*

- Never rest objects of any kind on the air conditioner.
- Never obstruct the air intake or outlet grilles.

## CLEANING

Before cleaning or maintenance, turn the appliance off by touching the  button, then unplug from the outlet.

### CLEANING THE CABINET

You should clean the appliance with a slightly damp cloth then dry with a dry cloth. For safety reasons, never wash the air conditioner with water.

**Attention!** Never use petrol, alcohol or solvents to clean the appliance. Never spray insecticide liquids or similar.

### CLEANING THE BIO SILVER AIR FILTER

The BioSilver filter helps capture dust and pollen and helps reduce the growth of bacteria and mold on the filter.

If the filter is dirty, air circulation is compromised and the efficiency of the appliance decreases. It is therefore good practice to clean the filter at regular intervals. The frequency depends on the duration and conditions of operation. If the unit is used constantly or systematically, you are recommended to clean the

filter once a week.

The filter is housed in the intake grille.

To clean the filter, extract as shown in fig. 11.

Use a vacuum cleaner to remove the dust collected on the filter. If it is very dirty, immerse in warm water and rinse a number of times. The water should never be hotter than 40°C.

After washing the filter, allow it to dry completely before repositioning it.

## START OF SEASON CHECKS

Make sure the power cable and plug are undamaged and the earth system is efficient.

Follow the installation instructions precisely.

## END OF SEASON OPERATIONS

To drain all water from the circuit, remove the external cap by unscrewing it in the anticlockwise direction (fig. 12) and allow the water to drain out into a basin.

When the appliance is empty, replace the caps.

Clean the filter and dry thoroughly before putting back.

## TECHNICAL SPECIFICATIONS

Power supply voltage see rating label

Max. absorbed power

during air conditioning

Refrigerant

Cooling capacity

Frequency 2402.0-2483.5 MHz

Maximum transmission power 0,0631 W

## LIMIT CONDITIONS

Room temperature for air conditioning

18° ÷ 35°C

**Transport, filling, cleaning, recovery and disposal of refrigerant should be performed by a technical service centre appointed by the manufacturer only.**

**The appliance should be disposed of by a specialist centre appointed by the manufacturer only.**

### **Attention! TO AVOID DAMAGE TO THE UNIT:**

NEVER TRANSPORT OR TURN THE APPLIANCE UPSIDE DOWN OR ON ITS SIDE. IF THIS OCCURS, WAIT 6 HOURS BEFORE TURNING THE APPLIANCE ON, 24 HOURS IS RECOMMENDED. After the unit has been on its side, oil needs to return to the compressor to ensure proper function. Without allowing the unit this time (6-24 hours) the unit may function for only a short time, and then the compressor will break down from lack of oil.

## TROUBLESHOOTING

PROBLEM	CAUSE	SOLUTION
The air conditioner does not come on	it is not plugged into the outlet	plug into the outlet
	there is no current	wait
	the internal safety device has tripped	call the Service Center
The air conditioner works for a short time only	there are bends or kinks in the air exhaust hose	position the air hose correctly, keeping it as short and free of curves as possible to avoid bottlenecks
	something is preventing the air from being discharged	check and remove any obstacles obstructing air discharge
The air conditioner works, but does not cool the room	windows, doors and/or curtains open	close doors, windows and curtains, bearing in mind the "TIPS FOR CORRECT USE" given above
	there are heat sources in the room (oven, hairdryer, etc)	eliminate the heat sources
	the air exhaust hose is detached from the appliance	fit the air exhaust hose in the housing at the back of the appliance (fig. 1).
	filter clogged	clean or replace the filter as described above
	the technical specification of the appliance is not adequate for the room in which it is located.	
During operation, there is an unpleasant smell in the room	filter clogged	clean the filter as described above
The air conditioner does not operate for about three minutes after restarting it	an internal safety device prevents the appliance from being restarted until three minutes have elapsed since it was last turned off	wait. This delay is part of normal operation.
One of the following messages is displayed: Lt/Lh/PF/H L/E1	the appliance has a self diagnosis system to identify a number of malfunctions.	see the SELF-DIAGNOSIS chapter