

electriQ

USER MANUAL

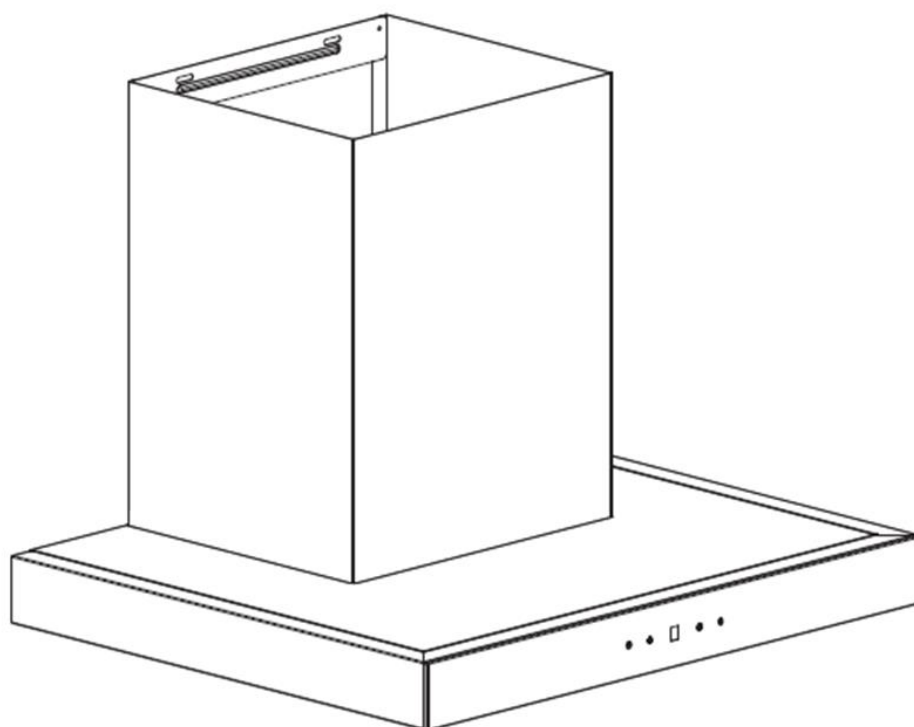

COOKER HOOD **TOUCH CONTROL COOKER HOOD**

eiQ60touchslim

eiQ90touchslim

Thank you for choosing electriQ
Please read this user manual before using this
product and keep it safe for future reference.
Visit our page www.electriQ.co.uk for our entire product range

CONTENTS

SAFETY	3
VENTILATION	5
INSTALLATION	6
OPERATION	9
CLEANING AND MAINTENANCE	9
FILTER CLEANING AND REPLACEMENT	10
BULB REPLACEMENT	11
TROUBLESHOOTING	12
SUPPORT	13

SAFETY PRECAUTIONS

Whilst this product is compliant with all safety requirements, incorrect or inappropriate use can lead to both personal injury and potential damage to property. Please read the contents of this instruction booklet thoroughly before fitting or using this appliance.

- The cooker hood must be installed in accordance with the installation instructions and all measurements followed.
- All installation work must be carried out by a competent person or qualified electrician.
- The unit must be connected to an earthed power supply.
- If venting externally, make sure the ducting has no bends sharper than 90 degrees as this will reduce the efficiency of the cooker hood.
- The cooker hood is for domestic use only and is not designed for commercial use. It should only be used for the purpose it was intended – to extract vapours and cooking odours.
- Do not flambé or use an open flame under the cooker hood.
- Do not try to use the cooker hood without the grease filters or if the filters are excessively greasy. They should be cleaned regularly (see “Maintenance”) or replaced as necessary.
- The extraction fan must be level to avoid grease collection at one end, as this could cause a potential fire risk.
- Do not leave frying pans unattended during use because overheated fat or oils might catch fire.
- If the cooker hood is damaged, do not attempt to use it.
- If the supply cord is damaged, it must be replaced by the manufacturer, its service agent or a similarly qualified person in order to avoid a hazard.
- This appliance can be used by children aged from 8 years and above and persons with reduced physical, sensory or mental capabilities or lack of experience and knowledge if they have been given supervision or instruction concerning use of the appliance in a safe way and understand the hazards involved.
- Children shall not play with the appliance. Cleaning and user maintenance shall not be made by children without supervision.
- Children should be supervised to ensure that they do not play with the appliance. It is not a toy.
- The plug must be accessible after installation for isolation in case of an emergency – or an appropriate fused switch if the unit is hard-wired to the mains via a spur.

- The minimum distance between the surface of the hob and the lowest part of the hood should be at least 65cm. A distance of between 65cm and 75cm gives peak efficiency.
- The air must not be discharged into a flue that is used for exhausting fumes from appliances burning gas or other fuels.
- When the hood is vented externally and used with appliances which burn fuel (e.g. gas, oil, wood) the area must be sufficiently ventilated to ensure safe operation. Fresh air must be allowed to freely enter the room to prevent a partial vacuum.
- A partial vacuum can starve the heating appliance of oxygen, impairing combustion. It can also prevent toxic fumes from leaving the room, or can cause fumes to be sucked into the room from outside.
- Safe operation is only possible when the partial vacuum within the working area does not exceed 4 Pa (0.04 mbar). This can be achieved by ensuring air is able to enter the room from outside through a suitable sized opening which cannot be sealed during operation. A number of alternative solutions are available to ensure this. If in any doubt, professional advice should be sought.
- Regulations concerning the discharge of air have to be fulfilled.
- There is a potential fire risk if cleaning is not carried out in accordance with the instructions.
- Clean your appliance periodically by following the method given in the chapter MAINTENANCE
- If used in recirculation mode, the charcoal filters trap odours and must be replaced at least once a year depending on how frequently the cooker hood has been used.
- For safety reasons, please use only the same size of fixing or mounting screw, which are recommended in this instruction manual.
- Warning: Failure to install the screws or fixing device in accordance with these instructions may result in electrical hazards

CAUTION: Accessible parts of the hood can become very hot during use with cooking appliances, whether in use or not, due to heat rising from the hob. Sufficient time should be allowed for the unit to cool before touching either the housing or the grease filters

INSTALLATION (VENT OUTSIDE) MOUNTING OF THE V-FLAP

If the cooker hood does not have an assembled V-flap 1, you should mount the half-parts to its body. The images only show an example of how to mount the V-flap, the outlet may be various according to different models and configuration. To mount the V-flap 1 you should:

1. Mount two half-parts "2" into the body "6"
2. A pin 3 should be top oriented
3. The axis "4" should be inserted in the holes "5" on body
4. Repeat all the operations for the 2nd half-part

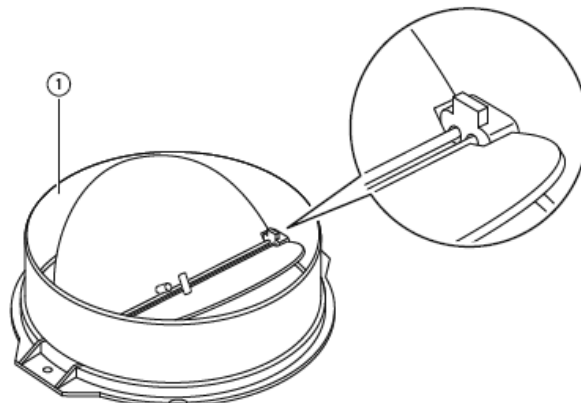
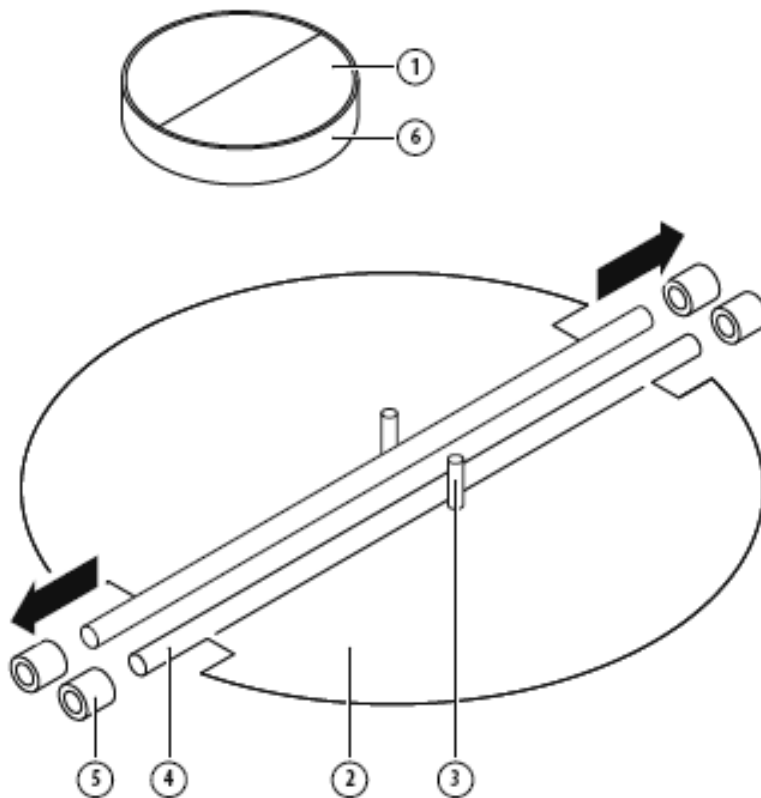

OPTIONS FOR VENTILATION

This hood can be set up for either external venting or recirculation of the air. The type of setup should be decided before commencing installation.

INSTALLATION

If you have an outlet to the outside, your cooker hood can be connected as below picture by means of an extraction duct (enamel, aluminum, flexible pipe or non-flammable material with an interior diameter of 150mm)

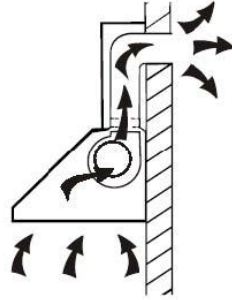

1. Before installation, turn the unit off and unplug it from the outlet.



2. The cooker hood should be placed at a distance of 65~75cm above the cooking plane for best effect.

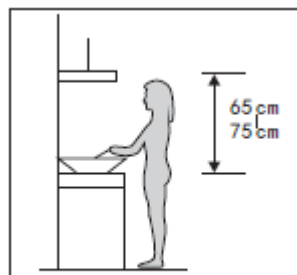

Pic 1

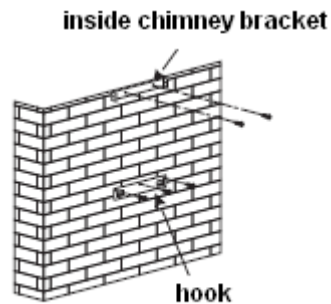

Pic 2

3. Install the hook on a suitable place once the installation height is fixed, and keep it in line. The fixed position of the inside chimney bracket is the highest place of chimney. See pic 2.

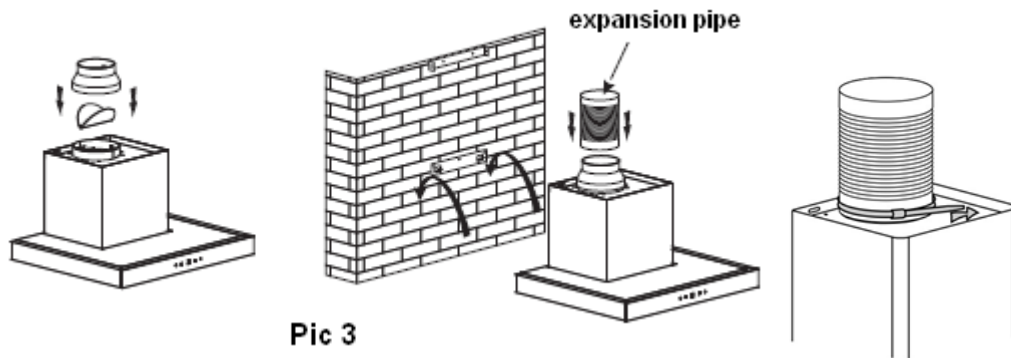

Pic 3

4. Put the v-flaps and converter onto the hood, fix the expansion pipe with cable tie on the outlet. Then hang the hood on to the hook. See pic 3.

5. Fix the outside chimney bracket on the outside chimney with 2 pcs ST4*8mm screws, and be sure that the inside chimney can be adjusted the height in it freely. Afterwards, install chimneys on the cooker hood. Lay the expansion pipe to the wall outlet. Fix the expansion pipe with the cable tie on the wall-outlet. See Pic4.

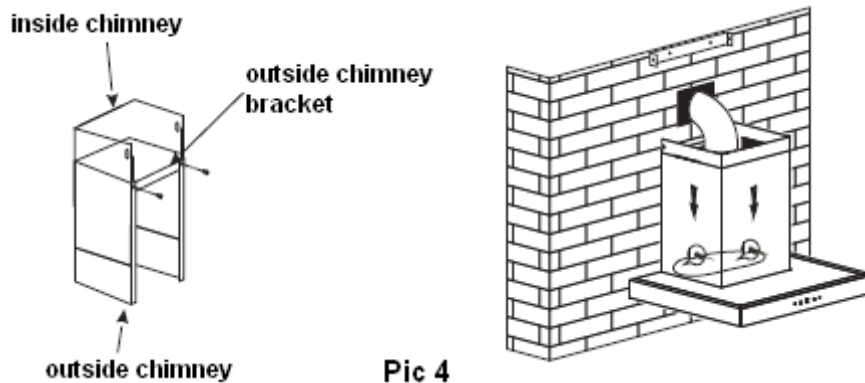

Pic 4

6. Adjust the height of the inside chimney to the position of the inside chimney bracket and fix on it by 2pcs ST4*8 screws. See Pic 5.

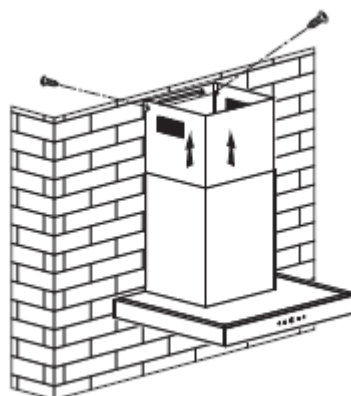

Pic 5

HINTS FOR EXHAUST DUCT INSTALLATION

The following rules must be strictly followed to obtain optimal air extraction:

- Keep expansion pipe short and straight.
- Do not reduce the size or restrict expansion pipe.
- When using expansion pipe always install the pipe pulled taut to minimize pressure loss.
- Failure to observe these basic instructions will reduce the performance and increase noise levels of the cooker hood.
- Any installation work must be carried out by a qualified electrician or competent person.
- Do not connect the ducting system of the hood to any existing ventilation system which is being used for any other appliance, such as warmer tube, gas tube, hot wind tube.
- The angle of the bend of the expansion pipe should not be less than 120°; you must direct the pipe horizontally, or, alternatively, the pipe should go up from the initial point and should be led to an outer wall.
- After the installation, make sure that the cooker hood is level to avoid grease collection at one end.
- Ensure the expansion pipe selected for installation complies with relevant standards and is fire retardant.

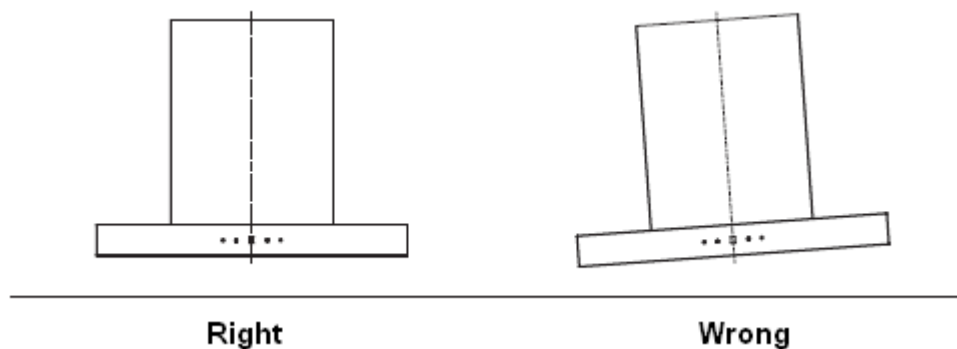

START USING YOUR COOKER HOOD

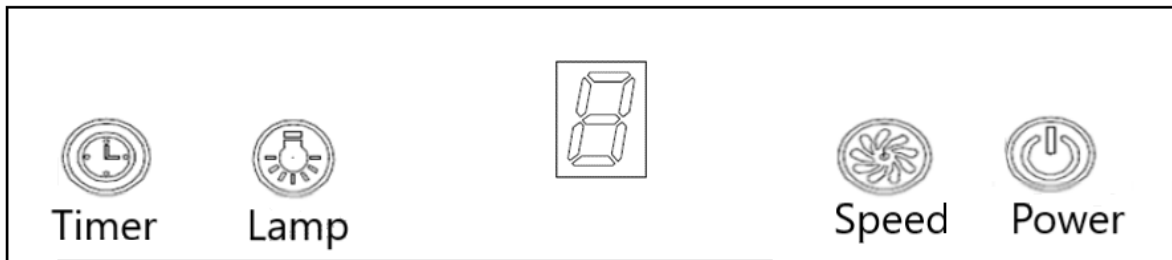

1. Press the “Power” button, to turn the cooker hood on and off.
2. Press the “Speed” button to cycle between fan speeds, the LED display will indicate the fan speed with the numbers 1, 2 and 3.
3. Press “Light” button to turn the hoods light on and off.
4. When the hood is on, press the “Timer” button and the LED will begin to display a countdown of 9 minutes. When the countdown is complete, the cooker hood will turn off.

MAINTENANCE

Before cleaning, switch the unit off and pull out the plug, or switch off at the relevant mains switch if the unit has been hard-wired in. Make sure the unit has no power being fed to it.

REGULAR CLEANING

Use a soft cloth moistened with warm mildly soapy water or household cleaning detergent. Never use metal pads, chemicals, abrasive material or a stiff brush to clean the unit.

NOTE: Do not use a steam-cleaner to clean the hood; electrical components could be damaged or short-circuit as a result.

INSTALLING GREASE MESH FILTERS

- To install filters for the following four steps.
- Angle the filter into slots at the back of the hood.
- Push the button on handle of the filter.
- Release the handle once the filter fits into a resting position.
- Repeat to install all filters.

Replacements are available from the retailer the hood was purchased from under reference: 90cm- **eiqgfslim90**/ 60cm- **eiqgfslim**

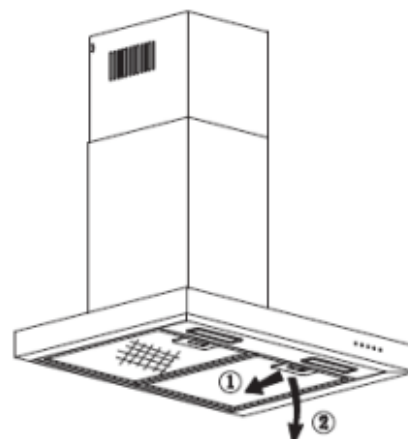

CARBON FILTER-not supplied

Activated carbon filter can be used to trap odors. Normally the activated carbon filter should be changed at three or six months according to your cooking habit. The installation procedure of activated carbon filter is as below.

Replacements are available from the retailer the hood was purchased from under reference: **eiqcf150**

- (1) The aluminum filter should be detached first. Press the lock and pull it downward.
- (2) The dismantle method of carbon filter can refer to below pictures.
- (3) Take out the carbon filter and change it with a new one.
- (4) Apply reverse procedure to install the charcoal filter.
- (5) Put the aluminium filter back.



NOTE:

- Make sure the filter is securely locked. Otherwise, it would loosen and cause dangerous.
- When activated carbon filter attached, the suction power will be lowered.

BULB REPLACEMENT

IMPORTANT: The light fitting must be replaced by the manufacturer, its service agent or similarly qualified persons

Before changing the bulb, ensure the hood is turned off and the power is disconnected before attempting to change the bulb. Wait until the flitting has cooled down before commencing replacement.

CHANGING THE LIGHTS:

Remove the grease filter.

Use a tool or hand to press the spring splinter of both sides of LED light to the inside, until the light is pressed out, see pic 1.

Then slightly pull the light connecting wire out, and dismantle the terminal of the light connecting wire. See pic 2.

Apply the reverse procedure to install the light back.

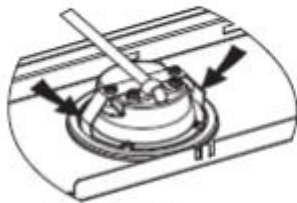

Pic 1



Pic 2

ILCOS D code for this lamp is: DSR-1.5/65-S-64

- LED modules – round lamp
- Max wattage: 2×1.5W
- Voltage range: DC 12V

Dimensions:

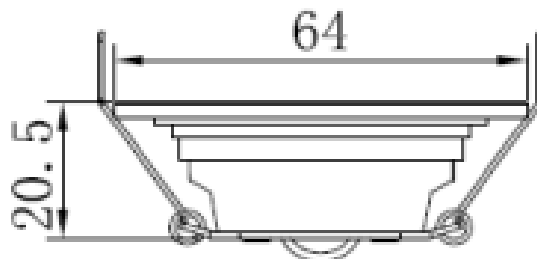

TROUBLESHOOTING

Fault	Possible Cause	Solution
Light on, but motor does not work	Fan switch turned off	Select a fan switch position.
	Fan switch failed	Contact service center.
	Motor failed	Contact service center.
Light does not work, motor does not work	House fuses blown	Reset/Replace fuses.
	Power cord loose or disconnected	Refit cord to power outlet. Switch power outlet on.
Oil leakage	One way valve and the outlet are not tightly sealed	Take down the one way valve and seal with sealant.
	Leakage from the connection of chimney and cover	Take chimney down and seal.
Lights not working	Broken/Faulty globes	Replace globes as per this instruction.
Insufficient suction	The distance between the cooker hood and the gas top is too far	Refit the cooker hood to the correct distance.
The Cooker hood inclines	The fixing screw not tight enough	Tighten the hanging screw and make it horizontal.

NOTE:

Any electrical repairs to this appliance must conform to your local, state and federal laws. Please contact the service centre if in any doubt before undertaking any of the above. Always disconnect the unit from the power source when opening the unit.

INFORMATION FOR DISMANTLING

Do not dismantle the appliance in a way which is not shown in the user manual. The appliance could not be dismantled by user. At the end of life, the appliance should not be disposed of with household waste. Check with your Local Authority or retailer for recycling advice.

INFORMATION FOR DISMANTLING

Do not dismantle the appliance in any way which is not shown in the user manual. The appliance must not be dismantled by an unqualified person. At the end of its life, the appliance should not be disposed of with general household waste. Check with your Local Authority or retailer for recycling advice.

electriQ UK SUPPORT

www.electriQ.co.uk/support

Call: 0330 390 3061

Office hours: 9AM - 5PM Monday to Friday

www.electriQ.co.uk

Unit J6, Lowfields Business Park
Lowfields Way, Elland
West Yorkshire, HX5 9DA



Recycling facilities are now available for all customers at which you can deposit your old electrical products. Customers will be able to take any old electrical equipment to participating sites run by their local councils. Please remember that this equipment will be further handled during the recycling process, so please be considerate when depositing your equipment. Please contact the local council for details of your local household waste recycling centers.